

Lifting Appliances and Anchor Handling Winches

Object of Amendment

Regulations / Guidance for the Classification and Registry of Ships
Rules for the Survey and Construction of Steel Ships Parts CSR-B&T, K, O, P, and T
Guidance for the Survey and Construction of Steel Ships Parts U, D, O, and P
Rules / Guidance for Cargo Handling Appliances
Rules for Diving Systems
Rules for the Survey and Construction of Passenger Ships
Rules for the Survey and Construction of Inland Waterway Ships
Rules for Floating Docks
Guidance for the Approval and Type Approval of Materials and Equipment for Marine Use

Reason for Amendment

The Society has traditionally stipulated its requirements related to the design, construction, installation, inspection, etc. of cargo handling appliances used for loading and unloading cargoes separately from its requirements related to the design, construction, installation, inspection, etc. for anchor handling winches used for setting the anchors of other ships. The former are stipulated in the Rules for Cargo Handling Appliance, whereas the latter are stipulated in Chapter 8 (“Anchoring Handling Vessels”) of Part O of the Rules for the Survey and Construction of Steel Ships and Chapter 15 (“Surveys for Work-ships”) of 15 Part B of the Rules for the Survey and Construction of Steel Ships.

At the 89th session of the IMO’s Maritime Safety Committee (MSC89) held in 2011, however, several flag state administrations (including Japan) proposed the establishment of international uniform standards for the purpose of reducing accidents involving cargo lifting appliances.

Although the IMO discussions on the aforementioned proposal initially dealt with cargo lifting appliances, the establishment of international uniform standards for anchor handling winches was subsequently proposed. The IMO, therefore, expanded the scope of the discussion to consider the establishment of uniform standards in SOLAS for cargo lifting appliances and anchor handling winches.

At MSC107 held in 2023, a draft amendment to SOLAS related to cargo lifting appliances and anchor handling winches was adopted as IMO resolution MSC. 532 (107). In addition, guidelines describing specific requirements were approved as MSC.1/Circ.1663 and MSC.1/Circ. 1662.

Accordingly, relevant requirements are amended based on MSC.532(107), MSC.1/Circ.1663 and MSC.1/Circ.1662. In addition, the Rules for Cargo Handling Appliances is renamed as the Rules for Lifting Appliances and Anchor Handling Winches, with requirements related to anchor handling winches being moved into it from Parts B and O.

Outline of Amendment

The main contents of this amendment are as follows:

(1) Changes the name of the “Rules for Cargo Handling Appliances” to “Rules for Lifting

Appliances and Anchor Handling Winches” and reorganises it into two parts: Part 1 (requirements for lifting appliances) and Part 2 (requirements for anchor handling winches).

- (2) Specifies requirements related to the application, definition, manufacturing, design, testing, survey, operation, maintenance, inspection, etc. of lifting appliances as Part 1 of the Rules for Lifting Appliances and Anchor Handling Winches in accordance with *IMO* resolution *MSC.532(107)* and *IMO* circular *MSC.1/Circ.1663*.
- (3) Specifies requirements related to application, definitions, manufacturing, design, testing, survey, operation, maintenance, inspection, etc. of anchor handling winches as Part 2 of the Rules for Lifting Appliances and Anchor Handling Winches based on *IMO* resolution *MSC.532(107)* and *IMO* circular *MSC.1/Circ.1662*.

Effective Date and Application

This draft amendment applies on or after 1 January 2026

An asterisk (*) after the title of a requirement indicates that there is also relevant information in the corresponding Guidance.

ID:DD24-27

DRAFT

Amended-Original Requirements Comparison Table (Lifting Appliances and Anchor Handling Winches)

Amended	Original	Remarks
<p>REGULATIONS FOR THE CLASSIFICATION AND REGISTRY OF SHIPS</p> <p>Chapter 3 REGISTRATION OF INSTALLATIONS</p> <p>3.1 Installations Registration</p> <p>3.1.1 General* Installations indicated in (1) to (16) hereunder of the ship to be registered or registered under 2.1 will be assigned characters and registered in the Installations Register defined in 3.1.4 when the installations have been surveyed for registration by the Surveyors in accordance with the rules for the survey and construction of installations provided separately (hereinafter referred to as “the Installation Rules”) and found by the Society to be in compliance with the requirements of the Installation Rules. However, the Society may refuse the registration of installations regardless of the results of the survey in accordance with 1.4-3 of the Conditions of Service for Classification of Ships and Registration of Installations.</p> <p>(1) Cargo Refrigerating Installations (2) <u>Lifting Appliances and Anchor Handling Winches</u> (3) Marine Pollution Prevention Installations (4) Safety Equipment (5) Radio Installations (6) Automatic and Remote Control Systems</p>	<p>REGULATIONS FOR THE CLASSIFICATION AND REGISTRY OF SHIPS</p> <p>Chapter 3 REGISTRATION OF INSTALLATIONS</p> <p>3.1 Installations Registration</p> <p>3.1.1 General* Installations indicated in (1) to (16) hereunder of the ship to be registered or registered under 2.1 will be assigned characters and registered in the Installations Register defined in 3.1.4 when the installations have been surveyed for registration by the Surveyors in accordance with the rules for the survey and construction of installations provided separately (hereinafter referred to as “the Installation Rules”) and found by the Society to be in compliance with the requirements of the Installation Rules. However, the Society may refuse the registration of installations regardless of the results of the survey in accordance with 1.4-3 of the Conditions of Service for Classification of Ships and Registration of Installations.</p> <p>(1) Cargo Refrigerating Installations (2) <u>Cargo Handling Appliances</u> (3) Marine Pollution Prevention Installations (4) Safety Equipment (5) Radio Installations (6) Automatic and Remote Control Systems</p>	<p>Adds anchor handling winches to the scope of Installation Registers</p>

Amended-Original Requirements Comparison Table (Lifting Appliances and Anchor Handling Winches)

Amended	Original	Remarks
<p>(7) Navigation Bridge Systems (8) Diving Systems (9) Preventive Machinery Maintenance Systems (10) Integrated Fire Control Systems (11) Hull Monitoring System (12) Anti-Fouling Systems on Ships (13) Centralized Cargo Monitoring and Control Systems (14) Ballast Water Management Installations (15) Inventory of Hazardous Materials (16) Other installations deemed appropriate by the Society</p> <p>3.1.2 Installations Character(s)* 1 The installations applicable to 3.1.1 will be distinguished by the following characters (hereinafter referred to as “Installations Character(s)”) <ul style="list-style-type: none"> (1) RMC and RMC·CA: Installations in 3.1.1(1) (2) CHG and AHW: Installations in 3.1.1(2) (3) MPP: Installations in 3.1.1(3) (4) LSA: Installations in 3.1.1(4) (5) RCF: Installations in 3.1.1(5) (6) MC, M0, M0·A, M0·B, M0·C, and M0·D: Installations in 3.1.1(6) (7) BRS, BRS1, and BRS1A: Installations in 3.1.1(7) (8) DVS: Installations in 3.1.1(8) (9) PMM: Installations in 3.1.1(9) (10) IFC·M, IFC·A, and IFC·AM: Installations in 3.1.1(10) (11) HMS and HMS·R: Installations in 3.1.1(11) (12) AFS and AFS·C: Installations in 3.1.1(12) (13) CCM: Installations in 3.1.1(13) (14) BWM: Installations in 3.1.1(14) (15) IHM: Installations in 3.1.1(15) (16) Installations in 3.1.1(16) are to be given as </p>	<p>(7) Navigation Bridge Systems (8) Diving Systems (9) Preventive Machinery Maintenance Systems (10) Integrated Fire Control Systems (11) Hull Monitoring System (12) Anti-Fouling Systems on Ships (13) Centralized Cargo Monitoring and Control Systems (14) Ballast Water Management Installations (15) Inventory of Hazardous Materials (16) Other installations deemed appropriate by the Society</p> <p>3.1.2 Installations Character(s)* 1 The installations applicable to 3.1.1 will be distinguished by the following characters (hereinafter referred to as “Installations Character(s)”) <ul style="list-style-type: none"> (1) RMC and RMC·CA: Installations in 3.1.1(1) (2) CHG: Installations in 3.1.1(2) (3) MPP: Installations in 3.1.1(3) (4) LSA: Installations in 3.1.1(4) (5) RCF: Installations in 3.1.1(5) (6) MC, M0, M0·A, M0·B, M0·C, and M0·D: Installations in 3.1.1(6) (7) BRS, BRS1, and BRS1A: Installations in 3.1.1(7) (8) DVS: Installations in 3.1.1(8) (9) PMM: Installations in 3.1.1(9) (10) IFC·M, IFC·A, and IFC·AM: Installations in 3.1.1(10) (11) HMS, HMS·R: Installations in 3.1.1(11) (12) AFS and AFS·C: Installations in 3.1.1(12) (13) CCM: Installations in 3.1.1(13) (14) BWM: Installations in 3.1.1(14) (15) IHM: Installations in 3.1.1(15) (16) Installations in 3.1.1(16) are to be given as </p>	<p>Adds anchor handling winches to the scope of Installation Registers</p>

Amended-Original Requirements Comparison Table (Lifting Appliances and Anchor Handling Winches)

Amended	Original	Remarks
appropriate	appropriate	

DRAFT

Amended-Original Requirements Comparison Table (Lifting Appliances and Anchor Handling Winches)

Amended	Original	Remarks
<p align="center">RULES FOR THE SURVEY AND CONSTRUCTION OF STEEL SHIPS</p> <p align="center">Part CSR-B&T COMMON STRUCTURAL RULES FOR BULK CARRIERS AND OIL TANKERS</p> <p align="center">Part 1 GENERAL HULL REQUIREMENTS</p> <p align="center">Chapter 1 RULE GENERAL PRINCIPLES</p> <p align="center">Section 1 APPLICATION</p> <p>2. Rule Application</p> <p>2.5 Limits of Application to Lifting Appliances 2.5.2 Rule application for lifting appliances The fixed parts of lifting appliances and their connections to the ship's structure are to be accordance with the relevant requirements of <u>Part 1, Rules for Lifting Appliances and Anchor Handling Winches</u>, irrespective of the registration of such <u>lifting</u> appliances.</p>	<p align="center">RULES FOR THE SURVEY AND CONSTRUCTION OF STEEL SHIPS</p> <p align="center">Part CSR-B&T COMMON STRUCTURAL RULES FOR BULK CARRIERS AND OIL TANKERS</p> <p align="center">Part 1 GENERAL HULL REQUIREMENTS</p> <p align="center">Chapter 1 RULE GENERAL PRINCIPLES</p> <p align="center">Section 1 APPLICATION</p> <p>2. Rule Application</p> <p>2.5 Limits of Application to Lifting Appliances 2.5.2 Rule application for lifting appliances The fixed parts of lifting appliances and their connections to the ship's structure are to be accordance with the relevant requirements of the <u>Rules for Cargo Handling Appliances</u>, irrespective of the registration of such <u>cargo handling</u> appliances.</p>	

Amended-Original Requirements Comparison Table (Lifting Appliances and Anchor Handling Winches)

Amended	Original	Remarks
<p>RULES FOR THE SURVEY AND CONSTRUCTION OF STEEL SHIPS</p> <p>Part K MATERIALS</p> <p>Chapter 3 ROLLED STEELS</p> <p>3.1 Rolled Steels for Hull</p> <p>3.1.8 Verification of Dimensions*</p> <p>6 In accordance with the requirements in 1.3.4-1, <u>Part 1 of the Rules for Lifting Appliances and Anchor Handling Winches</u>, where extremely thick steel plates are used and where it is deemed by Society to be impracticable to comply with the requirements in -1 to -5 above, a treatment different from that specified in said requirements may be accepted.</p>	<p>RULES FOR THE SURVEY AND CONSTRUCTION OF STEEL SHIPS</p> <p>Part K MATERIALS</p> <p>Chapter 3 ROLLED STEELS</p> <p>3.1 Rolled Steels for Hull</p> <p>3.1.8 Verification of Dimensions*</p> <p>6 In accordance with the requirements in 1.3.4-1, <u>Rules for Cargo Handling Appliances</u>, where extremely thick steel plates are used and where it is deemed by Society to be impracticable to comply with the requirements in -1 to -5 above, a treatment different from that specified in said requirements may be accepted.</p>	

Amended-Original Requirements Comparison Table (Lifting Appliances and Anchor Handling Winches)

Amended	Original	Remarks
<p style="text-align: center;">RULES FOR THE SURVEY AND CONSTRUCTION OF STEEL SHIPS</p> <p style="text-align: center;">Part O WORK-SHIPS</p> <p style="text-align: center;">Chapter 2 DREDGERS</p> <p>2.4 Hull Equipment</p> <p>2.4.1 General 3 <u>Lifting appliances</u> are to be at the discretion of the Society.</p> <p style="text-align: center;">Chapter 3 CRANE SHIPS</p> <p>3.4 Hull Equipment</p> <p>3.4.1 General* 3 <u>Lifting appliances</u> are to be at the discretion of the Society.</p>	<p style="text-align: center;">RULES FOR THE SURVEY AND CONSTRUCTION OF STEEL SHIPS</p> <p style="text-align: center;">Part O WORK-SHIPS</p> <p style="text-align: center;">Chapter 2 DREDGERS</p> <p>2.4 Hull Equipment</p> <p>2.4.1 General 3 <u>Cargo gear</u> is to be at the discretion of the Society.</p> <p style="text-align: center;">Chapter 3 CRANE SHIPS</p> <p>3.4 Hull Equipment</p> <p>3.4.1 General* 3 <u>Cargo gear</u> is to be at the discretion of the Society.</p>	

Amended-Original Requirements Comparison Table (Lifting Appliances and Anchor Handling Winches)

Amended	Original	Remarks
<p>Chapter 4 VESSELS ENGAGED IN TOWING OPERATIONS</p> <p>4.4 Hull Equipment</p> <p>4.4.1 General* 3 <u>Lifting appliances</u> are to be at the discretion of the Society.</p> <p>Chapter 7 OFFSHORE SUPPLY VESSELS</p> <p>7.4 Hull Equipment</p> <p>7.4.1 General* 3 <u>Lifting appliances</u> are to be at the discretion of the Society.</p>	<p>Chapter 4 VESSELS ENGAGED IN TOWING OPERATIONS</p> <p>4.4 Hull Equipment</p> <p>4.4.1 General* 3 <u>Cargo gear</u> is to be at the discretion of the Society.</p> <p>Chapter 7 OFFSHORE SUPPLY VESSELS</p> <p>7.4 Hull Equipment</p> <p>7.4.1 General* 3 <u>Cargo gear</u> is to be at the discretion of the Society.</p>	

Amended-Original Requirements Comparison Table (Lifting Appliances and Anchor Handling Winches)

Amended	Original	Remarks
<p>Chapter 8 ANCHOR HANDLING VESSELS</p> <p>8.3 Hull Construction</p> <p>8.3.2 Supporting Structures of Anchor Handling Equipment*</p> <p>1 The supporting structures in way of parts where anchors are loaded are to be such to ensure sufficient strength. <u>The supporting structures of anchor handling winches are to comply with 1.3.2, Part 2 of the Rules for Lifting Appliances and Anchor Handling Winches.</u></p> <p>(Deleted)</p> <p>8.3.3 Suitable Construction for Anchor Handling Operation</p> <p>1 Ships are to have completely clear after decks in order to effectively handle <u>anchor handling operations.</u></p> <p>(Same)</p>	<p>Chapter 8 ANCHOR HANDLING VESSELS</p> <p>8.3 Hull Construction</p> <p>8.3.2 Supporting Structures of Anchor Handling Equipment*</p> <p>1 The supporting structures <u>of anchor handling equipment and</u> in way of parts where anchors are loaded are to be such to ensure sufficient strength.</p> <p>2 The design loads for the supporting structures of anchor handling equipment are not to be less than the breaking strength of the anchor handling equipment, the maximum braking capacity of the winch, or the maximum hoisting capacity of the winch, whichever is the greatest.</p> <p>8.3.3 Suitable Construction for Anchor Handling Operation</p> <p>1 Ships are to have completely clear after decks in order to effectively handle anchors.</p> <p>2 In cases where anchor handling operations are conducted using after deck stern rollers, the aft terminals in way of the stern areas for anchor handling are to be round in shape.</p>	<p>Transfers the requirements for the supporting structures of anchor handling winches to “1.3.2-2, Part 2 of the Rules for Lifting Appliances and Anchor Handling Winches”</p> <p>Transfers to “1.3.2-2, Part 2 of the Rules for Lifting Appliances and Anchor Handling Winches”</p>

Amended-Original Requirements Comparison Table (Lifting Appliances and Anchor Handling Winches)

Amended	Original	Remarks
<p>8.4 Hull Equipment</p> <p>8.4.1 General*</p> <p>(Same)</p> <p>(Same)</p> <p>3 <u>Lifting appliances</u> are to be at the discretion of the Society.</p> <p>8.4.3 Safety Devices <u>Safety devices for anchor handling winches are to comply with Chapter 3, Part 2 of the Rules for Lifting Appliances and Anchor Handling Winches.</u></p> <p>8.4.4 Equipment for Anchor Handling (Same)</p>	<p>8.4 Hull Equipment</p> <p>8.4.1 General*</p> <p>1 Hull equipment is to be according to this 8.4 in addition to relevant requirements in each chapter of Part C, Part CS or Part Q.</p> <p>2 In cases where equipment and devices for the ship's purpose are fitted, suitable measures are to be taken so that ship safety is not impaired.</p> <p>3 <u>Cargo gear</u> is to be at the discretion of the Society.</p> <p>8.4.3 Safety Devices <u>Equipment, such as winches, for anchor handling operations is to be provided with suitable safety devices so that towing wires are able to be released or cut in times of emergency.</u></p> <p>8.4.4 Equipment for Anchor Handling Anchor handling equipment components such as fixtures, the stern roller, pin connections are, in principle, are to be capable of sustaining the breaking strength of the towlines, etc. However, in cases where design loads are determined in advance and are clearly indicated on board the ship, such loads may be used in lieu of the breaking strength of the towlines, etc. when deemed appropriate by the Society.</p>	

Amended-Original Requirements Comparison Table (Lifting Appliances and Anchor Handling Winches)

Amended	Original	Remarks
<p>8.5 Machinery</p> <p>8.5.1 General</p> <p>1 Machinery installations of the ship are to be <u>in accordance with Part D.</u></p> <p>2 <u>Anchor handling winches of the ship are to comply with Chapter 3, Part 2 of the Rules for Lifting Appliances and Anchor Handling Winches.</u></p> <p>(Deleted)</p> <p>(Deleted)</p>	<p>8.5 Machinery</p> <p>8.5.1 General</p> <p>Machinery installations of the ship are to be <u>according to this 8.5 in addition to Part D.</u></p> <p>(Newly added)</p> <p>8.5.2 Control Stations</p> <p>1 Anchor handling and towing winch equipment are to be capable of being operated from a control station located on the navigation bridge and at least one additional control station located on deck with an unobstructed view of the equipment.</p> <p>2 Each control station is to be equipped with suitable control elements, such as operating levers, whose functions are clearly marked. Wherever practical, control levers are to be moved in the direction of the intended topline movement. In addition, operating levers are to automatically return to the stop position upon release and are to be capable of being secured in the stop position.</p> <p>3 Means are to be provided for measuring the tension of anchor handling and tow lines for display at control stations.</p> <p>8.5.3 Winch Brakes</p> <p>Each winch for anchor handling is to be provided with a means of power control braking. Such as means is to be regenerative, dynamic, counter torque breaking, controlled lowering or mechanically controlled braking which is capable of maintaining control at low speeds. Brakes are to be applied</p>	<p>Same as “3.2.4, Part 2 of the Rules for Lifting Appliances and Anchor Handling Winches”</p> <p>Same as “3.2.1, Part 2 of the Rules for Lifting Appliances and Anchor Handling Winches”</p> <p>Transfers to “3.2.2, Part 2 of the Rules for Lifting Appliances and Anchor Handling Winches”</p> <p>Transfers to “3.2.8, Part 2 of the Rules for Lifting Appliances and Anchor Handling Winches”</p>

Amended-Original Requirements Comparison Table (Lifting Appliances and Anchor Handling Winches)

Amended	Original	Remarks
<p>(Deleted)</p>	<p>automatically upon loss of power or whenever winch levers are returned to the neutral position.</p> <p>8.5.4 Power Supply When the power supply for normal operation of anchor handling or towing winch equipment is the same as the power supply for propulsion equipment, such as shaft generators, shaft power take-offs (PTO), etc., an independent (redundant) power supply with sufficient capacity for winch operation is to be available to ensure that ship maneuverability during anchor handling or towing operations is not degraded.</p>	<p>Transfers to “3.2.9, Part 2 of the Rules for Lifting Appliances and Anchor Handling Winches”</p>
<p>8.5.2 Tests (Same)</p>	<p>8.5.5 Tests 1 Before installation on board, equipment and components constituting the machinery installations are to be tested at the manufacturers in accordance with the relevant requirements in Part D.</p>	
<p>(Same)</p>	<p>2 Notwithstanding the requirements in -1, for machinery installations, other than boilers, pressure vessels belonging to Group I or II and piping systems which contain inflammable or toxic liquids, used solely for the operation which is the purpose of the ship, the tests may be deemed appropriate by the Society.</p>	
<p>(Same)</p>	<p>3 The systems or the equipment essential for the safety of the ship or for the propulsion of the ship (only applicable to the ship which has the main propulsion machinery) are, after installed on board, to be subjected to performance tests. (Newly added)</p>	
<p><u>4 Anchor handling winches of the ship are to comply with Chapter 3, Part 2 of the Rules for Lifting Appliances and Anchor Handling Winches.</u></p>		

Amended-Original Requirements Comparison Table (Lifting Appliances and Anchor Handling Winches)

Amended	Original	Remarks
<p>Chapter 9 VESSELS ENGAGED IN LAYING OBJECTS ON THE SEABED</p> <p>9.4 Hull Equipment</p> <p>9.4.1 General* 3 <u>Lifting appliances</u> are to be at the discretion of the Society.</p> <p>Chapter 11 WIND TURBINE INSTALLATION SHIPS</p> <p>11.15 <u>Lifting</u> Appliances</p> <p>11.15.1 General <u>Lifting appliances</u> are to be <u>in accordance with Part 1 of the Rules for Lifting Appliances and Anchor Handling Winches</u>. In addition, they are to be at the discretion of the Society.</p> <p>11.15.2 Supporting Equipment of <u>Lifting</u> Appliances Supporting equipment for <u>lifting</u> appliances, such as boom rests, etc., is to be appropriately designed so as to be capable of withstanding loads due to ship motions and inclination.</p>	<p>Chapter 9 VESSELS ENGAGED IN LAYING OBJECTS ON THE SEABED</p> <p>9.4 Hull Equipment</p> <p>9.4.1 General* 3 <u>Cargo gear</u> is to be at the discretion of the Society.</p> <p>Chapter 11 WIND TURBINE INSTALLATION SHIPS</p> <p>11.15 <u>Cargo Handling</u> Appliances</p> <p>11.15.1 General <u>Cargo handling appliances</u> are to be <u>according to the Rules for Cargo Handling Appliances</u>. In addition, they are to be at the discretion of the Society.</p> <p>11.15.2 Supporting Equipment of <u>Cargo Handling</u> Appliances Supporting equipment for <u>cargo</u> appliances, such as boom rests, etc., is to be appropriately designed so as to be capable of withstanding loads due to ship motions and inclination.</p>	

Amended-Original Requirements Comparison Table (Lifting Appliances and Anchor Handling Winches)

Amended	Original	Remarks
<p>Chapter 12 Wind Farm Support Vessels</p> <p>12.9 Special Requirements for Ships Primarily Engaged in Transporting Workers</p> <p>12.9.1 General Where ships have personnel transfer arrangements or <u>lifting appliances</u> which effect stability, and loads heavy cargoes on deck, 12.8 is to be complied with.</p>	<p>Chapter 12 Wind Farm Support Vessels</p> <p>12.9 Special Requirements for Ships Primarily Engaged in Transporting Workers</p> <p>12.9.1 General Where ships have personnel transfer arrangements or <u>cargo gear</u> which effect stability, and loads heavy cargoes on deck, 12.8 is to be complied with.</p>	

DRAFT

Amended-Original Requirements Comparison Table (Lifting Appliances and Anchor Handling Winches)

Amended	Original	Remarks
<p align="center">RULES FOR THE SURVEY AND CONSTRUCTION OF STEEL SHIPS</p> <p align="center">Part P MOBILE OFFSHORE DRILLING UNITS AND SPECIAL PURPOSE BARGES</p> <p align="center">Chapter 9 HULL EQUIPMENT</p> <p>9.4 Equipment for Special Purpose</p> <p>9.4.1 General 2 <u>Lifting appliances are to be in accordance with Chapter 12 of the 2009 MODU Code as defined in 1.2.36.</u></p> <p align="center">Chapter 18 OPERATING REQUIREMENT</p> <p>18.3 Records</p> <p>18.3.2 Other Records</p> <p>If not included in the official log or tour record, the following additional information or records are to be maintained for a period acceptable to the Administration:</p> <ul style="list-style-type: none"> (1) Survey records for Periodical Surveys (2) Inspection and maintenance records related to means 	<p align="center">RULES FOR THE SURVEY AND CONSTRUCTION OF STEEL SHIPS</p> <p align="center">Part P MOBILE OFFSHORE DRILLING UNITS AND SPECIAL PURPOSE BARGES</p> <p align="center">Chapter 9 HULL EQUIPMENT</p> <p>9.4 Equipment for Special Purpose</p> <p>9.4.1 General 2 <u>Cargo gear is to be at the discretion of the Society.</u></p> <p align="center">Chapter 18 OPERATING REQUIREMENT</p> <p>18.3 Records</p> <p>18.3.2 Other Records</p> <p>If not included in the official log or tour record, the following additional information or records are to be maintained for a period acceptable to the Administration:</p> <ul style="list-style-type: none"> (1) Survey records for Periodical Surveys (2) Inspection and maintenance records related to means 	

Amended-Original Requirements Comparison Table (Lifting Appliances and Anchor Handling Winches)

Amended	Original	Remarks
<p>of access specified in 9.6.5</p> <p>(3) Light ship data alterations log specified in 12.5.2-5(3)(b)ii), Part B</p> <p>(4) Testing records and equipment changes for anchors and related equipment specified in 10.3.3</p> <p>(5) Maintenance, inspection and testing records related to fire-fighting systems specified in 15.2.16-4</p> <p>(6) Maintenance records related to life-saving equipment specified in 1.1.1-8, Chapter 1 of the Rules for Safety Equipment</p> <p>(7) Inspections of cranes <u>and records of tests</u> specified in <u>Chapter 12 of the 2009 MODU Code</u></p> <p>(8) Rated capacities of lifting and hoisting equipment specified in 9.4.1-2</p> <p>(9) Muster lists specified in 18.2.11-3</p> <p>(10) The electrical equipment register specified in 13.4</p> <p>(11) Maintenance and repair of all electrical equipment in hazardous areas for continued certification in accordance with the international standards referred to in paragraph 13.4</p>	<p>of access specified in 9.6.5</p> <p>(3) Light ship data alterations log specified in 12.5.2-5(3)(b)ii), Part B</p> <p>(4) Testing records and equipment changes for anchors and related equipment specified in 10.3.3</p> <p>(5) Maintenance, inspection and testing records related to fire-fighting systems specified in 15.2.16-4</p> <p>(6) Maintenance records related to life-saving equipment specified in 1.1.1-8, Chapter 1 of the Rules for Safety Equipment</p> <p>(7) Inspections of cranes specified in <u>Rules for Cargo Handling Appliances</u></p> <p>(8) Rated capacities of lifting and hoisting equipment specified in 9.4.1-2</p> <p>(9) Muster lists specified in 18.2.11-3</p> <p>(10) The electrical equipment register specified in 13.4</p> <p>(11) Maintenance and repair of all electrical equipment in hazardous areas for continued certification in accordance with the international standards referred to in paragraph 13.4</p>	<p>Considers original requirement of 1.1.1-3 of the Rules for Cargo Handling Appliances</p>

Amended-Original Requirements Comparison Table (Lifting Appliances and Anchor Handling Winches)

Amended	Original	Remarks
<p>RULES FOR THE SURVEY AND CONSTRUCTION OF STEEL SHIPS</p> <p>Part T SUBMERSIBLES</p> <p>Chapter 6 SUPPORT SYSTEMS</p> <p>6.1 Support Systems</p> <p>6.1.1 General*</p> <p>1 Support systems, in general, are to be composed of the support facilities specified below.</p> <p>(1) Towing systems which have sufficient capacity and strength to tow the submersible safely and passed through tests considered appropriate by the Society</p> <p>(2) Launch and recovery systems or cranes which are designed and manufactured by applying the requirements of <u>Part 1 of the Rules for Lifting Appliances and Anchor Handling Winches</u> by regarding the design lifting load or a load considered appropriate by the Society as the safe working load</p> <p>(3) Communication systems with the land support station or other ships</p> <p>(4) Devices to detect positions of the submersible corresponding to those specified in 4.2.7</p> <p>(5) Underwater communication systems corresponding to those specified in 4.2.8</p> <p>(6) Others deemed necessary by the Society in</p>	<p>RULES FOR THE SURVEY AND CONSTRUCTION OF STEEL SHIPS</p> <p>Part T SUBMERSIBLES</p> <p>Chapter 6 SUPPORT SYSTEMS</p> <p>6.1 Support Systems</p> <p>6.1.1 General*</p> <p>1 Support systems, in general, are to be composed of the support facilities specified below.</p> <p>(1) Towing systems which have sufficient capacity and strength to tow the submersible safely and passed through tests considered appropriate by the Society</p> <p>(2) Launch and recovery systems or cranes which are designed and manufactured by applying the requirements of the <u>Rules for Cargo Handling Appliances</u> by regarding the design lifting load or a load considered appropriate by the Society as the safe working load</p> <p>(3) Communication systems with the land support station or other ships</p> <p>(4) Devices to detect positions of the submersible corresponding to those specified in 4.2.7</p> <p>(5) Underwater communication systems corresponding to those specified in 4.2.8</p> <p>(6) Others deemed necessary by the Society in</p>	

Amended-Original Requirements Comparison Table (Lifting Appliances and Anchor Handling Winches)

Amended	Original	Remarks
<p>consideration of the operation form of the submersible</p> <p align="center">Chapter 7 TESTS</p> <p>7.2 Tests</p> <p>7.2.5 Tests for Support Systems Facilities for support systems are to undergo the tests specified below.</p> <p>(1) Performance tests on underwater communication systems and devices to detect positions of the submersible on sea trials at the maximum diving depth</p> <p>(2) The following tests on towing systems, housing systems, launch and <u>recovery</u> systems or cranes for lifting the submersible</p> <p>(a) As for the towing systems, tests to confirm the effectiveness of the systems</p> <p>(b) As for the housing systems, tests to confirm the effectiveness of the systems</p> <p>(c) As for the launch and recovery systems or cranes for lifting the submersible, tests correspondingly regarded to those specified in 2.4 and 2.5, <u>Part 1 of the Rules for Lifting Appliance and Anchor Handling Winches</u></p>	<p>consideration of the operation form of the submersible</p> <p align="center">Chapter 7 TESTS</p> <p>7.2 Tests</p> <p>7.2.5 Tests for Support Systems Facilities for support systems are to undergo the tests specified below.</p> <p>(1) Performance tests on underwater communication systems and devices to detect positions of the submersible on sea trials at the maximum diving depth</p> <p>(2) The following tests on towing systems, housing systems, launch and <u>revocery</u> systems or cranes for lifting the submersible</p> <p>(a) As for the towing systems, tests to confirm the effectiveness of the systems</p> <p>(b) As for the housing systems, tests to confirm the effectiveness of the systems</p> <p>(c) As for the launch and recovery systems or cranes for lifting the submersible, tests correspondingly regarded to those specified in 2.4 and 2.5 <u>of the Rules for Cargo Handling Appliances</u></p>	

Amended-Original Requirements Comparison Table (Lifting Appliances and Anchor Handling Winches)

Amended	Original	Remarks
<p style="text-align: center;"><u>RULES FOR LIFTING APPLIANCES AND ANCHOR HANDLING WINCHES</u></p> <p style="text-align: center;"><u>Part 1 LIFTING APPLIANCES</u></p> <p style="text-align: center;">Chapter 1 GENERAL</p> <p>1.1 General</p> <p>1.1.1 Application</p> <p>1 <u>Part 1 of the Rules for Lifting Appliances and Anchor handling Winches</u> (hereinafter referred to as “the Rules”) apply to <u>the following lifting appliances and loose gear</u> which are installed on the ships classed with NIPPON KAIJI KYOKAI (hereinafter referred to as “the Society”), and which are intended to be registered under Chapter 3 of the Regulations for the Classification and Registry of Ships.</p> <p>(1) <u>Lifting appliances installed on the following ships</u> (This, however, excludes cargo ramps, except for cargo lifts and cargo ramps which do not open, close or turn while loaded with cargo or other items)</p> <p>(a) <u>Passanger ships engaged on international voyages (including high speed craft that are considered to be passenger ships)</u></p> <p>(b) <u>Cargo ships not less than 500 gross tonnage engaged on international voyages (including high speed craft considered to be cargo ships)</u></p> <p>(2) <u>Loose gear installed on lifting appliances in (1) above</u></p>	<p style="text-align: center;"><u>RULES FOR CARGO HANDLING APPLIANCES</u></p> <p style="text-align: center;">(Newly added)</p> <p style="text-align: center;">Chapter 1 GENERAL</p> <p>1.1 General</p> <p>1.1.1 Application</p> <p>1 <u>The Rules for Cargo Handling Appliances</u> (hereinafter referred to as “the Rules”) apply to <u>the power operated cargo handling appliances</u> which are installed on the ships classed with NIPPON KAIJI KYOKAI (hereinafter referred to as “the Society”), and which are intended to be registered under Chapter 3 of the Regulations for the Classification and Registry of Ships.</p>	<p>Ships to which SOLAS II-1 applies</p>

Amended-Original Requirements Comparison Table (Lifting Appliances and Anchor Handling Winches)

Amended	Original	Remarks
<p>(3) <u>Based on the application submitted, lifting appliances and loose gear other than (1) and (2) above may also be applied.</u></p> <p><u>2 Notwithstanding 1 above, this Part 1 does not apply to the following lifting appliances and loose gear:</u></p> <p>(1) <u>Lifting appliances on ships certified as MODU (ships certified as MODU are those subject to the MODU Code and which carry a MODU Code Certificate on board issued by the Administration or a recognized organization).</u></p> <p>(2) <u>Lifting appliances used on offshore construction ships, such as pipe/cable laying/repair or offshore installation ships, including ships for decommissioning work, which comply with standards acceptable to the Administration.</u></p> <p>(3) <u>Integrated mechanical equipment for opening and closing hold hatch covers.</u></p> <p>(4) <u>Life-saving launching appliances complying with the International Life-Saving Appliance (LSA) Code.</u></p> <p><u>3 For lifting appliances with have a safe working load below 1 ton, the extent of application of the requirements for design, construction and installation and load tests (including thorough examinations immediately after load tests) specified in this Part 1 are to be determined at the discretion of the Administration.</u></p> <p><u>4 For lifting appliances installed on or after 1 January 2026, those covered by 1 and 2 above are to satisfy the following.</u></p> <p>(1) <u>Design, construction and installation are in accordance with this Part 1</u></p> <p>(2) <u>Load tests and thorough examinations are to be carried out in accordance with this Part 1 before being used for the first time after installation and after any</u></p>	<p>(Newly added)</p> <p>(Newly added)</p> <p>(Newly added)</p>	<p>Lifting appliances to which optionally applies SOLAS II-1/3-13.1.2</p> <p>SOLAS II-1/3-13.4 footnote 1</p> <p>SOLAS II-1/3-13.1.3</p> <p>SOLAS II-1/3-13.2.1 MSC.1/Circ.1663 Para3.1, 3.2.1.1</p>

Amended-Original Requirements Comparison Table (Lifting Appliances and Anchor Handling Winches)

Amended	Original	Remarks
<p><u>major repairs, modifications or alterations (the repairs or conversions referred to in 2.2.2-1 (4)).</u></p> <p>(3) <u>In accordance with this Part 1, safe working loads are to be permanently marked on appliances, and documentary evidence for said safe working loads is to be provided on board.</u></p> <p>5 <u>For lifting appliances installed before 1 January 2026, those covered by 1 and 2 above are to satisfy the following by the date of the first renewal survey on or after 1 January 2026, or after major repairs, modifications or alterations (the repairs or conversions referred to in 2.2.2-1 (4)).</u></p> <p>(1) <u>Load tests and thorough examinations are to be carried out in accordance with this Part 1. However, load tests and thorough examination may be omitted for lifting appliances with valid certificates for tests and thorough examinations under another international instrument acceptable to the Administration such as <i>ILO C152</i> that are issued prior to 1 January 2026.</u></p> <p>(2) <u>In accordance with this Part 1, safe working loads are to be permanently marked on appliances, and documentary evidence for said safe working loads is to be provided on board.</u></p> <p>6 <u>The “lifting appliances installed on or after 1 January 2026” referred to in 4 above means the following.</u></p> <p>(1) <u>for ships the keels of which are laid or which are at a similar stage of construction on or after 1 January 2026, any installation date on the ship; or</u></p> <p>(2) <u>for ships other than those specified in above (1), a contractual delivery date for the lifting appliance, or in the absence of a contractual delivery date, the actual delivery date of the lifting appliance to the ship on or after 1 January 2026.</u></p>	<p>(Newly added)</p>	<p>MSC.1/Circ.1663 Para3.2.1.2, 3.3.2, 3.3.3</p> <p>SOLAS II-1/2.33</p> <p>The actual delivery date is the date of delivery of the lifting appliances to the shipyard (when the ship is under construction) or the ship</p>

Amended-Original Requirements Comparison Table (Lifting Appliances and Anchor Handling Winches)

Amended	Original	Remarks
<p><u>7</u> For all lifting appliances, those covered by <u>1</u> and <u>2</u> above, and the loose gear used with the lifting appliances are to be operationally tested, thoroughly examined (except for thorough examinations after load tests), inspected, operated and maintained based on this Part 1.</p> <p><u>8</u> The relevant requirements in the Rules for the Survey and Construction of Steel Ships apply to the materials, equipment, installation and workmanship of the <u>lifting appliances</u>, unless otherwise specified in the Rules.</p> <p><u>9</u> Cranes used for personnel transfers are to comply with the requirements specified in the Annex 1.1.1-9 “Additional Requirements for Cranes Used for Personnel Transfers”, in addition to the requirements specified in the Rules. (Deleted)</p> <p>1.1.2 Equivalency*</p> <p><u>1</u> <u>Lifting appliances</u> and loose gear which do not comply with the requirements of <u>this Part 1</u> may be accepted, provided that they are considered by the Society to have the effectiveness equivalent to those complying with <u>this Part 1</u>.</p> <p><u>2</u> Any existing <u>lifting appliances</u> and loose gear designed and manufactured not under the requirements of <u>this Part 1</u> may be deemed by the Society to comply with <u>this Part 1</u>, provided that they comply with any rules or standards recognized by the Society to be appropriate and have passed the tests and inspection required by the Society.</p>	<p>(Newly added)</p> <p><u>2</u> The relevant requirements in the Rules for the Survey and Construction of Steel Ships apply to the materials, equipment, installation and workmanship of the cargo handling appliances, unless otherwise specified in the Rules.</p> <p><u>3</u> Cranes used for personnel transfers are to comply with the requirements specified in the Annex 1.1.1-3 “Additional Requirements for Cranes Used for Personnel Transfers”, in addition to the requirements specified in the Rules.</p> <p><u>4</u> For mobile offshore drilling units, the requirements specified in this Rule are to be complied with, and in addition, the requirements specified in 12.1 to 12.4, the “<i>2009 MODU Code</i>” defined in 1.2.36, Part P of the Rules for the Survey and Construction of Steel Ships are to be complied with.</p> <p>1.1.2 Equivalency*</p> <p><u>1</u> <u>Cargo gear, cargo ramps</u> and loose gear which do not comply with the requirements of <u>the Rules</u> may be accepted, provided that they are considered by the Society to have the effectiveness equivalent to those complying with <u>the Rules</u>.</p> <p><u>2</u> Any existing <u>cargo gear, cargo ramps</u> and loose gear designed and manufactured not under the requirements of <u>the Rules</u> may be deemed by the Society to comply with <u>the Rules</u>, provided that they comply with any rules or standards recognized by the Society to be appropriate and have passed the tests and inspection required by the Society.</p>	<p>(when the ship is in operation). SOLAS II-1/3-13.3</p> <p>Cargo ramps are included in lifting appliances and are deleted. Same as below.</p>

Amended-Original Requirements Comparison Table (Lifting Appliances and Anchor Handling Winches)

Amended	Original	Remarks
<p>1.1.3 1.1.3 Precautions in Application*</p> <p>1 As for the <u>lifting appliances</u> and loose gear, precautions are to be taken to any manners of their treatment different from the requirements of <u>this Part 1</u> in the flag state of the ship or state of call.</p> <p>(Same)</p> <p>1.2 Definitions</p> <p>1.2.1 Terminology*</p> <p>For the purpose of <u>this Part 1</u>, relevant terms are defined as given in the following (1) to (24) unless defined otherwise elsewhere:</p> <p>(Deleted)</p> <p>(1) <u>“Lifting appliance” is any of the following.</u></p> <p>(a) <u>Appliances used for cargo loading, transfer or discharge; this includes cargo lifts and cargo ramps which open or close or turn while loaded with cargo or other items.</u></p> <p>(b) <u>Appliances used for raising and lowering hold hatch covers or moveable bulkheads.</u></p> <p>(c) <u>Derrick systems</u></p> <p>(d) <u>Cranes (including engine room cranes, stores cranes, hose handling cranes, personnel handling cranes)</u></p>	<p>1.1.3 1.1.3 Precautions in Application*</p> <p>1 As for the <u>cargo gear, cargo ramps</u> and loose gear, precautions are to be taken to any manners of their treatment different from the requirements of <u>the Rules</u> in the flag state of the ship or state of call.</p> <p>2 The Society may carry out inspection and issue necessary certificates for the cargo handling appliances according to the designated rules in the capacity of the government of the state concerned or other organization under the authorization by such state or organization.</p> <p>1.2 Definitions</p> <p>1.2.1 Terminology*</p> <p>For the purpose of the Rules, <u>the</u> terms are defined as given in (1) through (18) below unless otherwise defined:</p> <p>(1) <u>Cargo handling appliances are lifting appliances and loose gear.</u></p> <p>(2) <u>Lifting appliances are cargo gears and cargo ramps include their installations of driving systems and cargo fittings.</u></p>	<p>Consideration for the special requirements of flag states or states of call.</p>

Amended-Original Requirements Comparison Table (Lifting Appliances and Anchor Handling Winches)

Amended	Original	Remarks
<p>(e) <u>Appliances used for the launch and recovery of tender boats and similar applications.</u></p> <p>(Deleted)</p> <p>(2) “Structural members” are those of <u>lifting</u> appliances carrying the safe working load, including cargo fittings and cargo blocks permanently incorporated in the <u>lifting appliance</u>.</p> <p>(3) “Cargo fittings” are goose neck brackets, topping brackets, fittings at the derrick boom head, derrick heel lugs, guy cleats, eye fittings, etc. which are permanently fitted to the structural members or the hull structure for the purpose of cargo handling.</p> <p>(4) “Loose gear” <u>is</u> blocks, ropes, chains, rings, hooks, shackles, swivels, clamps, grabs, lifting magnets, spreaders, etc. which are removable parts used for transmitting the loads of <u>cargo</u> to the structural members and which <u>do not form an integral part of the lifting appliances or loads generated by cargo</u>.</p> <p>(5) “Safe working load” is the maximum allowable mass of cargoes specified by <u>this Part 1</u> with which the <u>lifting appliances</u> can be safely operated. It is abbreviated to “<i>SWL</i>” and expressed in <i>tons (t)</i>.</p> <p>(6) “Allowable minimum angle” is the angle to horizontal of a derrick boom at which the derrick system is permitted to operate under the safe working load, and expressed in <i>degrees (°)</i>.</p> <p>(7) “Maximum slewing radius” is the radius at which a jib crane is permitted to operate under the safe working load and expressed in <i>meters (m)</i>.</p>	<p>(3) <u>Cargo gears are derrick systems, cranes, cargo lifts and other machinery used for the loading and unloading of cargo and other articles except cargo ramps, and include their installations of driving systems and cargo fittings.</u></p> <p>(4) Structural members are those of <u>cargo handling</u> appliances carrying the safe working load, including cargo fittings and cargo blocks permanently incorporated in the cargo gear <u>and the cargo ramps</u>.</p> <p>(5) Cargo fittings are goose neck brackets, topping brackets, fittings at the derrick boom head, derrick heel lugs, guy cleats, eye fittings, etc. which are permanently fitted to the structural members or the hull structure for the purpose of cargo handling.</p> <p>(6) Loose gears <u>are</u> blocks, ropes, chains, rings, hooks, shackles, swivels, clamps, grabs, lifting magnets, spreaders, etc. which are removable parts used for transmitting the loads of cargo to the structural members.</p> <p>(7) Safe working load is the maximum allowable mass of cargoes specified by the Rules with which the <u>cargo gear and the cargo ramp</u> can be safely operated. It is abbreviated to “<i>SWL</i>” and expressed in <i>tons (t)</i>.</p> <p>(8) Allowable minimum angle is the angle to horizontal of a derrick boom at which the derrick system is permitted to operate under the safe working load, and expressed in <i>degrees (°)</i>.</p> <p>(9) Maximum slewing radius is the radius at which a jib crane is permitted to operate under the safe working load, and expressed in <i>meters (m)</i>.</p>	

Amended-Original Requirements Comparison Table (Lifting Appliances and Anchor Handling Winches)

Amended	Original	Remarks
<p>(8) “Safe working load, etc.” are safe working load, allowable minimum angle and other restrictive conditions in case of the derrick systems, safe working load, maximum slewing radius and other restrictive conditions in case of the jib cranes, safe working load and other restrictive conditions deemed necessary by the Society in case of other machinery used for the loading and unloading of cargo, and safe working load and other restrictive conditions deemed necessary by the Society in case of the cargo ramps.</p> <p>(9) “Safe working load of loose gear” is the maximum allowable mass of cargoes specified by <u>this Part 1</u> with which the loose gear can be used safely. It is abbreviated to “<i>SWL</i>” and expressed in <i>tons (t)</i>. For cargo blocks, the safe working load is defined according to (a) or (b) below:</p> <p>(a) The safe working load of a single sheave block is the maximum mass of cargoes that can be safely lifted by that block when it is suspended by its head fitting and the mass is secured to a wire rope passing round its sheave.</p> <p>(b) The safe working load of a multiple sheave block is the maximum mass of cargoes that may be applied to its head fitting of the block.</p> <p>(10) “Derrick systems” are installations for handling cargo by suspending the cargo from the top of the derrick boom fitted to derrick post or mast, including those specified in (a), (b) and (c) below:</p> <p>(a) The end of topping lift being fixed, two guy ropes fitted at the top of the derrick boom are wound by independent winches respectively to swing the boom horizontally (hereinafter referred to as “<i>swinging derrick system</i>”).</p>	<p>(10) Safe working load, etc. are safe working load, allowable minimum angle and other restrictive conditions in case of the derrick systems, safe working load, maximum slewing radius and other restrictive conditions in case of the jib cranes, safe working load and other restrictive conditions deemed necessary by the Society in case of other machinery used for the loading and unloading of cargo, and safe working load and other restrictive conditions deemed necessary by the Society in case of the cargo ramps.</p> <p>(11) Safe working load of <u>a</u> loose gear is the maximum allowable mass of cargoes specified by the Rules with which the loose gear can be used safely. It is abbreviated to “<i>SWL</i>” and expressed in <i>tons (t)</i>. For cargo blocks, the safe working load is defined according to (a) or (b) below:</p> <p>(a) The safe working load of a single sheave block is the maximum mass of cargoes that can be safely lifted by that block when it is suspended by its head fitting and the mass is secured to a wire rope passing round its sheave.</p> <p>(b) The safe working load of a multiple sheave block is the maximum mass of cargoes that may be applied to its head fitting of the block.</p> <p>(12) Derrick systems are installations for handling cargo by suspending the cargo from the top of the derrick boom fitted to derrick post or mast, including those specified in (a), (b) and (c) below:</p> <p>(a) The end of topping lift being fixed, two guy ropes fitted at the top of the derrick boom are wound by independent winches respectively to swing the boom horizontally (hereinafter referred to as “<i>swinging derrick system</i>”).</p>	

Amended-Original Requirements Comparison Table (Lifting Appliances and Anchor Handling Winches)

Amended	Original	Remarks
<p>(b) Two derrick booms, on port and starboard sides, in pair are fixed at predetermined positions. The cargo falls of two derricks are connected to load or unload the cargo (hereinafter referred to as “<i>union-purchase derrick system</i>”).</p> <p>(c) The cargo fall can be paid out or heaved in and luffing and slewing of derrick boom can be carried out singly or simultaneously while the cargo is suspended (hereinafter referred to as “<i>derrick crane system</i>”).</p> <p>(11) “Cranes” cover jib cranes, gantry cranes, overhead cranes and hoists, cargo davits, etc. and are capable of performing the works of cargo loading and unloading, slewing and/or horizontal movement simultaneously or separately.</p> <p>(12) “Cargo lifts” are the installations designed to contain the cargo in their structure to loading and unloading the cargo.</p> <p>(13) “Cargo ramps” are the installation mounted on the shell or provided in the ship and arranged to permit passage of vehicles as cargo or vehicles loaded with cargo on themselves and having mechanism enabling its opening and closing or turning <u>while loaded with cargo or other items</u>.</p> <p>(14) “<i>JIS</i>” is an acronym for Japanese Industrial Standards.</p> <p>(15) “Lifting load” is the sum of the safe working load defined as the maximum mass of cargoes themselves to be suspended and the mass of accessories such as hooks, cargo blocks, grabs, buckets, lifting beams, spreaders, etc. Unless otherwise deemed necessary by the Society, the mass of wire ropes used as cargo falls need not be taken into account except when the installation is designed for a lift of 50 <i>m</i> or more.</p>	<p>(b) Two derrick booms, on port and starboard sides, in pair are fixed at predetermined positions. The cargo falls of two derricks are connected to load or unload the cargo (hereinafter referred to as “<i>union-purchase derrick system</i>”).</p> <p>(c) The cargo fall can be paid out or heaved in and luffing and slewing of derrick boom can be carried out singly or simultaneously while the cargo is suspended (hereinafter referred to as “<i>derrick crane system</i>”).</p> <p>(13) Cranes cover jib cranes, gantry cranes, overhead cranes and hoists, cargo davits, etc. and are capable of performing the works of cargo loading and unloading, slewing and/or horizontal movement simultaneously or separately.</p> <p>(14) Cargo lifts are the installations designed to contain the cargo in their structure to loading and unloading the cargo.</p> <p>(15) Cargo ramps are the installation mounted on the shell or provided in the ship, and arranged to permit passage of vehicles as cargo or vehicles loaded with cargo on themselves and having mechanism enabling its opening and closing or turning.</p> <p>(16) <i>JIS</i> is an acronym for Japanese Industrial Standards.</p> <p>(17) Lifting load is the sum of the safe working load defined as the maximum mass of cargoes themselves to be suspended and the mass of accessories such as hooks, cargo blocks, grabs, buckets, lifting beams, spreaders, etc. Unless otherwise deemed necessary by the Society, the mass of wire ropes used as cargo falls need not be taken into account except when the installation is designed for a lift of 50 <i>m</i> or more.</p>	

Amended-Original Requirements Comparison Table (Lifting Appliances and Anchor Handling Winches)

Amended	Original	Remarks
<p>(16) <u>“The acceleration of gravity” is to be equal to 9.81 m/sec².</u></p> <p>(17) <u>“Competent person” is a person possessing the knowledge and experience required for the performance of duties specified in this Rules and acceptable as such to the Administration.</u></p> <p>(18) <u>“Responsible person” is a person appointed by the master or company, as defined in regulation IX/1 of SOLAS, as appropriate, possessing the knowledge and experience required for the performance of duties specified in this Rules.</u></p> <p>(19) <u>“Inspection” is an assessment carried out by a responsible person to ascertain if the lifting appliance or loose gear is in good working condition for continued safe use.</u></p> <p>(20) <u>“Thorough examination” is a detailed assessment carried out by a competent person in order to determine whether the lifting appliance or loose gear is in compliance with the applicable requirements of the Administration.</u></p> <p>(21) <u>“Maintenance” is any activity carried out by a responsible person to keep the lifting appliance or loose gear in good working condition for continued safe use.</u></p> <p>(22) <u>“Operational testing” is a test carried out by a responsible person to verify the correct functioning of a component or operation of the lifting appliance or associated loose gear.</u></p> <p>(23) <u>“Load test” is a test in excess of the SWL, carried out in the presence of a competent person in order to check the structural integrity and adequacy of the lifting appliance, its attachments and its supporting structures.</u></p>	<p>(18) The acceleration of gravity is to be equal to 9.81 m/sec².</p>	

Amended-Original Requirements Comparison Table (Lifting Appliances and Anchor Handling Winches)

Amended	Original	Remarks
<p>(24) <u>“Proof test” is a load test of loose gear as specified in (23), carried out by manufacturers without a surveyor in attendance.</u></p> <p>(25) <u>“Certificate of test and thorough examination” refers to the certificate issued by a competent person upon satisfactory completion of the tests and thorough examinations of the lifting appliance or loose gear.</u></p> <p>1.3 Arrangement, Construction, Materials and Welding</p> <p>1.3.1 Arrangement</p> <p>1 The arrangement and dimensions of the <u>lifting appliances</u> are to be determined with due consideration given to avoid interference with manoeuvring lights, navigation lights and other functions of the ship.</p> <p>2 When same parts of the <u>lifting appliances</u> are utilized commonly for other functions, such as ventilators, or important systems or equipment designed for other purposes, or further, when some systems or equipment for other purposes are mounted on them, due considerations are to be given to avoid undue interference with each other in relation to their functions and strength.</p> <p>3 When any parts of the <u>lifting appliances</u> are project beyond the ship’s side under the working condition, it is recommended that such parts are to be of retractable, foldable or removable type designed for stowing within the line of ship’s side when not in use.</p> <p>4 <u>Lifting appliances</u> are to be provided with equipment for securing movable parts when not in use.</p>	<p>1.3 Arrangement, Construction, Materials and Welding</p> <p>1.3.1 Arrangement</p> <p>1 The arrangement and dimensions of the <u>cargo gear and the cargo ramps</u> are to be determined with due consideration given to avoid interference with manoeuvring lights, navigation lights and other functions of the ship.</p> <p>2 When same parts of the <u>cargo gear</u> are utilized commonly for other functions, such as ventilators, or important systems or equipment designed for other purposes, or further, when some systems or equipment for other purposes are mounted on them, due considerations are to be given to avoid undue interference with each other in relation to their functions and strength.</p> <p>3 When any parts of the <u>cargo gear and the cargo ramps</u> project beyond the ship’s side under the working condition, it is recommended that such parts are to be of retractable, foldable or removable type designed for stowing within the line of ship’s side when not in use.</p> <p>4 The <u>cargo gear and the cargo ramps</u> are to be provided with equipments for securing <u>the</u> movable parts when not in use.</p>	

Amended-Original Requirements Comparison Table (Lifting Appliances and Anchor Handling Winches)

Amended	Original	Remarks
<p>1.3.2 General Construction*</p> <p>1 <u>The lifting appliances</u> other than those used ordinary trim and heel in calm weather and sea states, are to comply with, in addition to the requirements in <u>this Part 1</u>, such additional requirements as considered appropriate by the Society for the actual working condition.</p> <p>(Same)</p> <p>(Same)</p> <p>(Same)</p> <p>(Same)</p> <p>(Same)</p>	<p>1.3.2 General Construction*</p> <p>1 The <u>cargo gear and the cargo ramps</u> other than those used ordinary trim and heel in calm weather and sea states, are to comply with, in addition to the requirements in the Rules, such additional requirements as considered appropriate by the Society for the actual working condition.</p> <p>2 The requirements in Chapter 3, 4 and 8 assume the use of hull structural rolled steels specified in 3.1, Part K of the Rules for the Survey and Construction of Steel Ships. High tensile steels used in the structural members, if any, are to comply with requirements specially made up by the Society. The construction and dimensions of the structural members containing or made of materials other than those steel specified herebefore are to be specially considered by the Society.</p> <p>3 The structural members are to be designed to avoid structural discontinuities and abrupt change of sections as far as practicable. The welded joints are to be arranged to avoid the parts where concentration of stress is expected.</p> <p>4 Corners of openings in the structural members are to be appropriately rounded off.</p> <p>5 Openings causing dimensional anisotropy in the structural members are to be so arranged as their long sides or long axes may assume parallel to the direction of principal stresses.</p> <p>6 Where two members having remarkably different stiffness are directly connected with each other, proper reinforcement is to be made by means of brackets, etc. to maintain the continuity of stiffness. Special consideration is to be given to the connection to the hull structures.</p> <p>7 The cargo blocks of the structural members are to comply with the requirements in 6.2.</p>	

Amended-Original Requirements Comparison Table (Lifting Appliances and Anchor Handling Winches)

Amended	Original	Remarks
<p>1.3.3 Direct Calculation of Strength The dimensions of the structural members are to be determined by the method of direct calculation of strength using the design loads and allowable stresses specified in respective Chapters concerned, with the exception of those members for which calculation formulae are given in Chapter 3.</p> <p>1.3.4 Materials* (Same)</p> <p>2 For the <u>lifting appliances</u> always used in especially cold zones or refrigerated hold chambers and for any other cases considered to be necessary by the Society, the Society may require the use of steel materials of higher notch toughness notwithstanding the requirement specified in -1. (Same)</p> <p>(Same)</p> <p>(Same)</p>	<p>1.3.3 Direct Calculation of Strength The dimensions of the structural members are to be determined by the method of direct calculation of strength <u>approved by the Society</u> using the design loads and allowable stresses specified in respective Chapters concerned, with the exception of those members for which calculation formulae are given in Chapter 3.</p> <p>1.3.4 Materials*</p> <p>1 The hull structural rolled steel used in the structural members are to be as given in Table 1.1 depending on their thickness, except in cases considered appropriate by the Society.</p> <p>2 For the <u>cargo gear and the cargo ramps</u> always used in especially cold zones or refrigerated hold chambers and for any other cases considered to be necessary by the Society, the Society may require the use of steel materials of higher notch toughness notwithstanding the requirement specified in -1.</p> <p>3 Steel casting and steel forgings used in the structural members are, as a rule, to comply with the requirements in 5.1 and 6.1, Part K of the Rules for the Survey and Construction of Steel Ships respectively or of equivalent qualities.</p> <p>4 The materials of bolts and nuts used for connection of components of the structural members are to be considered appropriate by the Society.</p> <p>5 Wire ropes used as components of the structural members are to be those specified in Part L of the Rules for the Survey and Construction of Steel Ships for use as standing riggings or of an equivalent quality.</p>	<p>Amends considering the actual situation</p>

Amended-Original Requirements Comparison Table (Lifting Appliances and Anchor Handling Winches)

Amended	Original	Remarks								
(Same)	<p>6 The materials used in the main parts of the installations of driving systems are to comply with the standard in Part K of the Rules for the Survey and Construction of Steel Ships or any standards recognized by the Society to be of equivalent qualities.</p>	No change								
<p align="center">Table 1.1 Thickness and Grades of Steels</p> <table border="1"> <thead> <tr> <th align="center">Thickness <i>t</i> (mm)</th> <th align="center">$t \leq 20$</th> <th align="center">$20 < t \leq 25$</th> <th align="center">$25 < t \leq 40$</th> <th align="center">$40 < t$</th> </tr> </thead> <tbody> <tr> <th align="center">Grade</th> <th align="center"><i>A/AH</i></th> <th align="center"><i>B/AH</i></th> <th align="center"><i>D/DH</i></th> <th align="center"><i>E/EH</i></th> </tr> </tbody> </table> <p>Note: <i>A, B, D, E, AH, DH,</i> and <i>EH</i> in the Table correspond to the following material grades. <i>A: KA AH: KA32, KA36 and KA40</i> <i>B: KB DH: KD32, KD36 and KD40</i> <i>D: KD EH: KE32, KE36 and KE40</i> <i>E: KE</i></p>	Thickness <i>t</i> (mm)		$t \leq 20$	$20 < t \leq 25$	$25 < t \leq 40$	$40 < t$	Grade	<i>A/AH</i>	<i>B/AH</i>	<i>D/DH</i>
Thickness <i>t</i> (mm)	$t \leq 20$	$20 < t \leq 25$	$25 < t \leq 40$	$40 < t$						
Grade	<i>A/AH</i>	<i>B/AH</i>	<i>D/DH</i>	<i>E/EH</i>						
1.3.5 Welding*	1.3.5 Welding*									
(Same)	<p>1 The Welding of the structural members is to comply with the requirements in Part M of the Rules for the Survey and Construction of Steel Ships and the additional requirements considered necessary by the Society according to the types of construction.</p>									
(Same)	<p>2 The arrangement of welded joints in the structural members is to be specially considered to avoid remarkable difficulties in welding work.</p>									

Amended-Original Requirements Comparison Table (Lifting Appliances and Anchor Handling Winches)

Amended	Original	Remarks
<p>1.3.6 Prevention of Corrosion (Same)</p> <p>(Same)</p> <p align="center">Chapter 2 SURVEYS</p> <p>2.1 General</p> <p>2.1.1 Application* 1 The requirements in this Chapter apply to the tests and surveys for the <u>lifting appliances and loose gear</u>. 2 Where the structural members of the <u>lifting</u> appliances are permanently fitted to the hull structure or where they form an integral part thereof, the tests and surveys for these parts are to comply with the requirements in this Chapter and, in addition they are to comply with the relevant requirements of the Rules for the Survey and Construction of Steel Ships.</p> <p>(Same)</p>	<p>1.3.6 Prevention of Corrosion 1 The Welding of the structural members is to comply with the requirements in Part M of the Rules for the Survey and Construction of Steel Ships and the additional requirements considered necessary by the Society according to the types of construction. 2 The arrangement of welded joints in the structural members is to be specially considered to avoid remarkable difficulties in welding work.</p> <p align="center">Chapter 2 SURVEYS</p> <p>2.1 General</p> <p>2.1.1 Application* 1 The requirements in this Chapter apply to the tests and surveys for the <u>cargo handling appliances</u>. 2 Where the structural members of the <u>cargo handling</u> appliances are permanently fitted to the hull structure or where they form an integral part thereof, the tests and surveys for these parts are to comply with the requirements in this Chapter and, in addition they are to comply with the relevant requirements of the Rules for the Survey and Construction of Steel Ships. 3 At the Periodical Surveys, the Society’s Surveyor (hereinafter referred to as “Surveyor”) may require other than those specified in 2.2 through 2.5 in this Chapter where deemed necessary.</p>	

Amended-Original Requirements Comparison Table (Lifting Appliances and Anchor Handling Winches)

Amended	Original	Remarks
<p>4 With respect to <u>Thorough Examinations</u> in cases where considered appropriate by the Society, the Surveyor may modify the extent and contents of the tests and surveys specified in 2.2 through 2.5 in this Chapter, where deemed appropriate, based on the purpose, construction, age, history, results of the previous surveys and the current condition of the <u>lifting</u> appliances.</p> <p>2.1.2 Preparation for Surveys and Others* (Same)</p> <p>(Same)</p>	<p>4 With respect to <u>Annual Thorough Surveys</u> in cases where considered appropriate by the Society, the Surveyor may modify the extent and contents of the tests and surveys specified in 2.2 through 2.5 in this Chapter, where deemed appropriate, based on the purpose, construction, age, history, results of the previous surveys and the current condition of the <u>cargo handling</u> appliances.</p> <p>2.1.2 Preparation for Surveys and Others*</p> <p>1 All such preparations as required for the survey to be carried out as well as those which may be required by the Surveyor as necessary in accordance with the requirements in the Rules are to be made by the applicant of the survey. The preparations are to include provisions of an easy and safe access, necessary facilities and necessary records for the execution of the survey. Inspection, measuring and test equipment, which Surveyors rely on to make decisions affecting classification are to be individually identified and calibrated to a standard deemed appropriate by the Society. However, the Surveyor may accept simple measuring equipment (<i>e.g.</i> rulers, measuring tapes, weld gauges, micrometers) without individual identification or confirmation of calibration, provided they are of standard commercial design, properly maintained and periodically compared with other similar equipment or test pieces. The Surveyor may also accept equipment fitted on board a ship and used in examination of shipboard equipment (<i>e.g.</i> pressure, temperature or rpm gauges and meters) based either on calibration records or comparison of readings with multiple instruments.</p> <p>2 The applicant for the survey is to arrange a supervisor who is well conversant with the survey items intended for the preparation of the survey to provide the necessary assistance</p>	

Amended-Original Requirements Comparison Table (Lifting Appliances and Anchor Handling Winches)

Amended	Original	Remarks
(Same)	<p>to the Surveyor according to his requests during the survey.</p> <p>3 The survey may be suspended where necessary preparations have not been made, any appropriate attendant mentioned in the previous -2 is not present, or the Surveyor considers that the safety for execution of the survey is not ensured.</p>	
(Same)	<p>4 Where repairs are deemed necessary as a result of the survey, the Surveyor will notify his recommendations to the applicant of the survey. Upon this notification, the repair is to be made to the satisfaction of the Surveyor.</p>	
(Same)	<p>5 In cases where it is necessary to replace any fittings, equipment or parts, etc. used onboard, replacements are to comply with the regulations to be applied during ship construction. However, in cases where new requirements are specified or where deemed necessary by the Society, the Society may require that such replacements comply with any new requirements in effect at the time the relevant replacement work is carried out. In addition, replacements are not to use any materials which contain asbestos.</p>	
<p>2.1.3 Presentation of Certificates All of the certificates for lifting appliances issued by the Society and <u>the certificates of tests and thorough examinations under another international instrument acceptable to the Administration</u> are to be presented to surveyor when requested at tests and surveys.</p>	<p>2.1.3 Presentation of Certificates All of the certificates for cargo handling appliances issued by the Society are to be presented to the Surveyor when requested at the tests and surveys.</p>	<p>Considers MSC.1/Circ.1663 Para.3.3.3</p>
<p>2.1.4 Records of Surveys The “Register of Ship’s <u>Lifting Appliances and Loose Gear</u>” is to be made necessary entries on it and endorsed by the Surveyor at the completion of the Surveys.</p>	<p>2.1.4 Records of <u>the</u> Surveys The “Register of Ship’s <u>Cargo handling Machinery and Gear</u>” is to be made necessary entries on it and endorsed by the Surveyor at the completion of the Surveys.</p>	<p>Same as MSC.1/Circ.1663 Para.3.2.3.1, 3.2.3.2, 3.3.4</p>

Amended-Original Requirements Comparison Table (Lifting Appliances and Anchor Handling Winches)

Amended	Original	Remarks
<p>2.1.5 Notification of Survey Results 1 The Surveyors <u>are</u> to notify the results of the Survey to the applicants <u>in the form of a Survey Record</u>. (Same) (Deleted) (Deleted)</p> <p><u>2.1.6 Out of Service for Lifting Appliances and Loose Gear</u> <u>If upon completion of a thorough examination, the competent person considers the lifting appliances and loose gear to be unsafe for operation or not in compliance with the applicable requirements of the Administration, then that lifting appliances and loose gear are to be taken out of service until any deficiency is rectified to the satisfaction of a competent person. The lifting appliances and loose gear are to be clearly marked “not to be used” and the status is be recorded in survey records and “Register of Ship’s Lifting Appliances and Loose Gear”. While out of service, 2.1.7 is to be followed.</u></p>	<p>2.1.5 Notification of Survey Results 1 The Surveyor <u>is</u> to notify the results of the Survey to the applicant <u>in a form of Survey Report</u>. 2 In case where repairing is requested by the attending Surveyor, the repairs are to be made to his satisfaction. 3 <u>The Survey Report in -1 is to be kept in the specified file and presented to the Surveyor at the subsequent Survey.</u></p> <p>2.1.6 Re-Survey <u>In case where the applicant has any complaints in the Survey carried out in accordance with the Rules, he may request execution of re-survey in writing to the Society.</u></p> <p>(Newly added)</p>	<p>Deleted because same as requirement Para.2.4 of Regulations for the Classification and Registry of Ships. Deleted because same as requirement Para.6.2 of Regulations for the Classification and Registry of Ships.</p> <p>SOLAS II-1/4</p> <p>MSC.1/Circ.1663 Para.3.2.2.3, 3.5.1.6</p>

Amended-Original Requirements Comparison Table (Lifting Appliances and Anchor Handling Winches)

Amended	Original	Remarks
<p><u>2.1.7 Inoperative Lifting Appliance and Loose Gear</u> <u>The following actions are to be taken by masters to mitigate risks posed by inoperative lifting appliances and loose gear:</u></p> <ol style="list-style-type: none"> <u>(1) take inoperative lifting appliances and loose gear into account when planning and executing a safe voyage;</u> <u>(2) prevent operation of inoperative lifting appliances and loose gear;</u> <u>(3) prevent uncontrolled movement of inoperative lifting appliances or their components using appropriate restraining and preventing arrangements, if required;</u> <u>(4) store inoperative loose gear separately from in-service loose gear and mark it as being inoperative;</u> <u>(5) record particular lifting appliances or loose gear that are inoperative in the “Register of Ship’s Lifting Appliances and Loose Gear” until necessary repairs have been completed, and it has been load tested or proof tested, as necessary, and thoroughly examined.</u> <p>2.2 Surveys of <u>Lifting Appliances and Loose Gear</u></p> <p>2.2.1 Kinds of Surveys The kinds of Surveys are as follows:</p> <ol style="list-style-type: none"> (1) Surveys for registration (hereinafter referred to as “Registration Survey”) <ol style="list-style-type: none"> (a) Registration Surveys during Construction (b) Registration Surveys of Cargo Handling Appliances not built under Survey (2) Periodical Surveys for maintaining registration 	<p>(Newly added) (Newly added)</p> <p>2.2 Surveys of <u>Cargo Handling Appliances</u></p> <p>2.2.1 Kinds of Surveys The kinds of Surveys <u>for cargo handling appliances</u> are as follows:</p> <ol style="list-style-type: none"> (1) Surveys for registration (hereinafter referred to as “Registration Survey”) <ol style="list-style-type: none"> (a) Registration Surveys during Construction (b) Registration Surveys of Cargo Handling Appliances not built under Survey (2) Periodical Surveys for maintaining registration 	<p>SOLAS II-1/4</p> <p>MSC.1/Circ.1663 Para.5</p>

Amended-Original Requirements Comparison Table (Lifting Appliances and Anchor Handling Winches)

Amended	Original	Remarks
<p>(a) <u>Thorough Examinations</u></p> <p>(b) Load Tests</p> <p>(c) Occasional Surveys</p> <p>(d) <u>Unscheduled Surveys</u></p> <p>2.2.2 Timing of Surveys*</p> <p>The timing of <u>surveys</u> are to be in accordance with the followings:</p> <p>(1) A Registration Survey is to be carried out when the safety working load, etc. are assigned for the first time.</p> <p>(2) <u>Thorough examinations are to be carried out at the following (a) to (c) times.</u></p> <p>(a) <u>At Registration Surveys</u></p> <p>(b) <u>At Annual Surveys, Intermediate Surveys and Renewal Surveys (at the request of the ship's owner, it may be limited to verification at Annual Surveys, Intermediate Surveys and Renewal Surveys that a thorough examination has been conducted or completed to the satisfaction of the Administration within a period, in principle, not exceeding 12 months from the date of completion of the previous thorough examination.)</u></p> <p>(c) <u>After load tests (including after proof tests)</u></p> <p>(3) Load Tests are to be carried out when the cargo handling appliances fall under any of the following.</p> <p>(a) <u>At Registration Surveys</u></p> <p>(b) <u>At dates not exceeding 5 years from the date of the previous Load Test (except loose gear)</u></p> <p>(c) <u>At Occasional Surveys when deemed necessary by the Society</u></p> <p>(4) An Occasional Survey is to be carried out when the</p>	<p>(a) <u>Annual Thorough Surveys (Periodical Survey)</u></p> <p>(b) <u>Load Tests (Periodical Survey)</u></p> <p>(c) Occasional Surveys</p> <p>(d) <u>Unscheduled Surveys</u></p> <p>2.2.2 Timing of Surveys*</p> <p>The timing of <u>the Surveys of cargo handling appliances</u> are to be in accordance with the followings:</p> <p>(1) A Registration Survey is to be carried out when the safety working load, etc. are assigned for the first time.</p> <p>(2) <u>Annual Thorough Surveys are to be carried out at the dates not exceeding 12 months from the date of completion of the Registration Survey or the previous Annual Thorough Survey.</u></p> <p>(3) Load Tests are to be carried out when the cargo handling appliances fall under any of the following.</p> <p>(a) <u>At the Registration Survey</u></p> <p>(b) <u>At the dates not exceeding 5 years from the date of completion of the Registration Survey or the previous Load Test</u></p> <p>(c) <u>At the Occasional Survey when deemed necessary by the Society</u></p> <p>(4) An Occasional Survey is to be carried out when the</p>	<p>As a premise, thorough examinations (annual) are to be conducted at the time of periodical surveys for classification.</p> <p>Interval for load tests is not to exceed 5 years.</p>

Amended-Original Requirements Comparison Table (Lifting Appliances and Anchor Handling Winches)

Amended	Original	Remarks
<p><u>lifting appliances and loose gear</u> fall under any of the following conditions at the time other than <u>Registration Surveys, thorough examinations, load tests, and unscheduled surveys</u>. To implement the survey, in lieu of the traditional ordinary surveys where a surveyor is in attendance, the Society may approve survey methods which it considers to be appropriate.</p> <p>(a) When serious damage is caused on the structural members and the repair or conversion is made</p> <p>(b) When major conversion is made in the cargo handling procedures, rigging arrangements, operation and control methods</p> <p>(c) When the assignment and marking of safe working load, etc. is altered</p> <p>(d) Other cases when considered necessary by the Society</p> <p>(5) The classed ships may be subject to <u>unscheduled surveys</u> when the confirmation of the status of appliances by survey is deemed necessary in cases where the Society considers the appliances to be subject to 1.4-3 of the Conditions of Service for Classification of Ships and Registration of Installations. At <u>unscheduled surveys</u>, investigations, examinations or tests are to be made to the satisfaction of the Surveyor with respect to the matters concerned.</p>	<p><u>cargo handling appliances</u> fall under any of the following conditions at the time other than <u>Periodical Surveys</u>. To implement the survey, in lieu of the traditional ordinary surveys where a surveyor is in attendance, the Society may approve survey methods which it considers to be appropriate.</p> <p>(a) When serious damage is caused on the structural members and the repair or conversion is made</p> <p>(b) When major conversion is made in the cargo handling procedures, rigging arrangements, operation and control methods</p> <p>(c) When the assignment and marking of safe working load, etc. is altered</p> <p>(d) Other cases when considered necessary by the Society</p> <p>(5) The classed ships may be subject to <u>Unscheduled Surveys</u> when the confirmation of the status of appliances by survey is deemed necessary in cases where the Society considers the appliances to be subject to 1.4-3 of the Conditions of Service for Classification of Ships and Registration of Installations. At <u>Unscheduled Surveys</u>, investigations, examinations or tests are to be made to the satisfaction of the Surveyor with respect to the matters concerned.</p>	

Amended-Original Requirements Comparison Table (Lifting Appliances and Anchor Handling Winches)

Amended	Original	Remarks
<p>2.2.3 <u>Through Examinations and Load Tests Carried Out in Advance</u> <u>Through examinations and load tests</u> may be carried out in advance of the due date of each <u>survey</u> upon application by the owner.</p> <p>2.2.4 <u>Postponement of Through Examinations and Load Tests</u> * <u>Thorough examinations and load tests may be postponed from the date specified in 2.2.2 subject to approval by the Administration and if deemed appropriate by the Society.</u></p> <p>2.2.5 <u>Laid-up Ships</u> (Same)</p> <p>2 When laid-up ships are about to be re-entering service, the following surveys and surveys for specific matters which have been postponed due to being laid-up, if any, are to be carried out.</p> <p>(1) If the due dates for Registration Maintenance Surveys have not transpired while the ship was laid-up, then an equivalent to the <u>thorough examinations</u> specified in 2.4 is to be carried out.</p> <p>(2) If the due dates for the <u>thorough examinations</u> specified in 2.4 have transpired while the ship was</p>	<p>2.2.3 <u>Periodical Surveys Carried Out in Advance</u> <u>Periodical Surveys</u> may be carried out in advance of the due date of each <u>Survey</u> upon application by the owner.</p> <p>2.2.4 <u>Postponement of Periodical Surveys*</u> <u>Periodical Surveys may be postponed subject to approval by the Society. The period of such postponement is not to exceed 3 months from the date specified in 2.2.2.</u></p> <p>2.2.5 <u>Laid-up Ships</u> 1 Laid-up ships are not subject to Registration Maintenance Surveys. However, Occasional Surveys may be carried out at the request of owners.</p> <p>2 When laid-up ships are about to be re-entering service, the following surveys and surveys for specific matters which have been postponed due to being laid-up, if any, are to be carried out.</p> <p>(1) If the due dates for Registration Maintenance Surveys have not transpired while the ship was laid-up, then an equivalent to the <u>Annual Thorough Surveys</u> specified in 2.4 is to be carried out.</p> <p>(2) If the due dates for the <u>Annual Thorough Surveys</u> specified in 2.4 have transpired while the ship was</p>	<p>Postponement is permitted based on approval by the Administration. Since the postponement period is determined by the Administration, the wording “not exceed 3 months” is deleted.</p>

Amended-Original Requirements Comparison Table (Lifting Appliances and Anchor Handling Winches)

Amended	Original	Remarks
<p>laid-up, such <u>thorough examinations</u> are to be carried out.</p> <p>(3) If the due dates for the <u>load tests</u> specified in 2.5 have transpired while the ship was laid-up, such Load Tests are to be carried out.</p> <p>2.3 Registration Surveys</p> <p>2.3.1 Drawings and Other Documents to be Submitted*</p> <p>1 At a Registration Survey, it is to be ascertained that the strength and construction of the <u>lifting appliances and loose gear</u> comply with the Rules based on the drawings and documents submitted to the Society. In this case, the applicant is to submit application form, in addition to the relevant drawings and documents out of listed in -2, -3 and -4.</p> <p>2 The drawings and documents listed in the following (1) to (11) are to be submitted for approval for <u>lifting appliances and loose gear</u> to be newly constructed:</p> <p>(1) <u>List and arrangement of lifting appliances</u></p> <p>(2) General arrangement of <u>lifting appliances</u></p> <p>(3) Construction drawings of lifting appliances (including the dimensions of structural members, specifications of materials and joint details)</p> <p>(4) Drawings of cargo fittings <u>for derricks</u> (including the dimensions, specifications of materials and the fixing methods of these fittings with structural members or hull structure)</p> <p>(5) Arrangement of loose gear (including rigging arrangement)</p> <p>(6) List of loose gear (showing the construction,</p>	<p>laid-up, such <u>Annual Thorough Surveys</u> are to be carried out.</p> <p>(3) If the due dates for the <u>Load Tests</u> specified in 2.5 have transpired while the ship was laid-up, such Load Tests are to be carried out.</p> <p>2.3 Registration Surveys</p> <p>2.3.1 Drawings and Other Documents to be Submitted*</p> <p>1 At a Registration Survey, it is to be ascertained that the strength and construction of the <u>cargo handling appliances</u> comply with the Rules based on the drawings and documents submitted to the Society. In this case, the applicant is to submit application form (<u>CG-APP</u>), in addition to the relevant drawings and documents out of listed in -2, -3 and -4.</p> <p>2 The drawings and documents listed in the following (1) through (11) are to be submitted for approval for <u>cargo handling appliances</u> to be newly constructed:</p> <p>(1) General arrangement of <u>cargo gears and cargo ramps</u></p> <p>(2) Construction drawings of <u>cargo gears and cargo ramps</u> (including the dimensions of structural members, specifications of materials and joint details)</p> <p>(3) Drawings of cargo fittings (including the dimensions, specifications of materials and the fixing methods of these fittings with structural members or hull structure)</p> <p>(4) Arrangement of loose gears (including rigging arrangement)</p> <p>(5) List of loose gears (showing the construction,</p>	

Amended-Original Requirements Comparison Table (Lifting Appliances and Anchor Handling Winches)

Amended	Original	Remarks
<p>dimensions, materials and locations. For those in compliance with the well-known code or standard, the type symbol may be used in place of dimensions and materials)</p> <p>(7) Construction drawings of driving gear</p> <p>(8) Power system diagram</p> <p>(9) Drawings of operation and control mechanism</p> <p>(10) Drawings of safety devices</p> <p>(11) Drawings of protective devices</p> <p>(12) Other drawings and documents as deemed necessary by the Society</p> <p>3 The drawings and documents listed in the following (1) to (7) are to be submitted for reference for <u>lifting appliances and loose gear</u> to be newly constructed:</p> <p>(1) Specifications for <u>lifting appliances</u></p> <p>(2) Calculation sheets or check sheets relevant to drawings and documents for approval specified in -2</p> <p>(3) Operation manual for <u>lifting appliances</u></p> <p>(4) Procedures of non-destructive testing</p> <p>(5) Procedures of Load tests</p> <p>(6) Asbestos-free declarations and supporting documents</p> <p>(7) Other drawings and documents as deemed necessary by the Society</p> <p>4 At a Registration Survey of <u>lifting appliances and loose gear</u> not built under <u>survey</u>, the drawings and data to be submitted for the cargo handling appliances are to be same as specified in -2 and -3. However, some of these drawings and documents may be omitted instead of submitting the past survey records and certificates with respect to them subject to approval by the Society.</p>	<p>dimensions, materials and locations. For those in compliance with the well-known code or standard, the type symbol may be used in place of dimensions and materials)</p> <p>(6) Construction drawings of driving gears</p> <p>(7) Power system diagram</p> <p>(8) Drawings of operation and control mechanism</p> <p>(9) Drawings of safety devices</p> <p>(10) Drawings of protective devices</p> <p>(11) Other drawings and documents as deemed necessary by the Society</p> <p>3 The drawings and documents listed in the following (1) through (7) are to be submitted for reference for <u>cargo handling appliances</u> to be newly constructed:</p> <p>(1) Specifications for <u>cargo gears and cargo ramps</u></p> <p>(2) Calculation sheets or check sheets relevant to drawings and documents for approval specified in -2</p> <p>(3) Operation manual for <u>cargo gears and cargo ramps</u></p> <p>(4) Procedures of non-destructive testing</p> <p>(5) Procedures of Load tests</p> <p>(6) Asbestos-free declarations and supporting documents</p> <p>(7) Other drawings and documents as deemed necessary by the Society</p> <p>4 At a Registration Survey of <u>cargo handling appliances</u> not built under <u>Survey</u>, the drawings and data to be submitted for the cargo handling appliances are to be same as specified in -2 and -3. However, some of these drawings and documents may be omitted instead of submitting the past survey records and certificates with respect to them subject to approval by the Society.</p>	

Amended-Original Requirements Comparison Table (Lifting Appliances and Anchor Handling Winches)

Amended	Original	Remarks
<p align="center">(Deleted)</p> <p><u>5 In cases where lifting appliances with safe working loads of less than 1 ton and loose gear used in such lifting appliances, drawings and documents accepted by the Society may be substituted, in part or in whole, for the drawings and documents in -2 and -3 above, if approved by the Society.</u></p> <p>2.3.2 Survey* 1 Workmanship of <u>lifting appliances and loose gear</u> is to be examined and ascertained to be in good order when any of the following (1) to (5) is relevant:</p> <ol style="list-style-type: none"> (1) When, in process of manufacturing and assembling of structural members, requested by the Society (2) When structural members are installed on board the ship (3) For driving gear, at the times when the finishing work on major parts is completed and when the Surveyor considers necessary during the process of manufacture (4) When the subcontracted materials, parts or equipment 	<p><u>5 The plans and documents specified in -2 and -3 above are to be submitted the Society in accordance with (1) to (3) below.</u></p> <ol style="list-style-type: none"> <u>(1) Where the submission of plans and documents by paper, 2 sets for the Society and necessary sets for returning to the applicant are to be submitted.</u> <u>(2) Where the submission of plans and documents electrically, the plans and documents are to be submitted using the systems prepared by the Society.</u> <u>(3) Where the submission of plans and documents by means other than (1) and (2) above, the plans and documents are to be submitted by the means deemed appropriate by the Society.</u> <p>(Newly added)</p> <p>2.3.2 Survey* 1 Workmanship of <u>cargo handling appliances</u> is to be examined and ascertained to be in good order when any of the following (1) through (5) is relevant:</p> <ol style="list-style-type: none"> (1) When, in process of manufacturing and assembling of structural members, requested by the Society (2) When structural members are installed on board the ship (3) For driving gears, at the times when the finishing work on major parts is completed and when the Surveyor considers necessary during the process of manufacture (4) When the subcontracted materials, parts or equipment 	<p>Specifies the handling for lifting appliances and loose gear with small SWL considering the usage of commercial products.</p>

Amended-Original Requirements Comparison Table (Lifting Appliances and Anchor Handling Winches)

Amended	Original	Remarks
<p>are incorporated to the <u>lifting appliances and loose gear</u></p> <p>(5) Other cases when considered necessary by the Society</p> <p>2 <u>Lifting appliances and loose gear</u> are to be examined and ascertained to be in good order by the following tests and surveys:</p> <p>(1) Testing as specified in Part K of the Rules for the Survey and Construction of Steel Ships where the materials need to be in compliance with the requirements in Part K</p> <p>(2) Testing as specified in Part M of the Rules for the Survey and Construction of Steel Ships where the welding works need to be in compliance with the requirements in Part M</p> <p>(3) Non-destructive testing where requested by the Surveyor</p> <p>(4) Shop trial of the driving gear</p> <p>(5) Operation tests of the <u>lifting appliances and loose gear</u></p> <p>(6) Operation tests of the safety devices and protective devices (including braking tests and electric power source cut-off tests with a testing weight equal to the safe working load applied (Hereinafter same in 2.4.1-1(2)(c), 2.4.2(2)(d), 2.4.3(2)(d) and 2.4.4-1(2)(c)))</p> <p>(7) Other tests considered necessary by the Society (Same)</p>	<p>are incorporated to the <u>cargo handling appliances</u></p> <p>(5) Other cases when considered necessary by the Society</p> <p>2 <u>Cargo handling appliances</u> are to be examined and ascertained to be in good order by the following tests and surveys:</p> <p>(1) Testing as specified in Part K of the Rules for the Survey and Construction of Steel Ships where the materials need to be in compliance with the requirements in Part K</p> <p>(2) Testing as specified in Part M of the Rules for the Survey and Construction of Steel Ships where the welding works need to be in compliance with the requirements in Part M</p> <p>(3) Non-destructive testing where requested by the Surveyor</p> <p>(4) Shop trial of the driving gears</p> <p>(5) Operation tests of the <u>cargo handling appliances</u></p> <p>(6) Operation tests of the safety devices and protective devices (including braking tests and electric power source cut-off tests with a testing weight equal to the safe working load applied (Hereinafter same in 2.4.1-1(2)(c), 2.4.2(2)(d), 2.4.3(2)(d) and 2.4.4-1(2)(c)))</p> <p>(7) Other tests considered necessary by the Society</p> <p>3 To implement the tests and the surveys specified in -1 and -2 (hereinafter referred to as survey in this sub-paragraph), in lieu of traditional ordinary surveys where the Surveyor is in attendance, the Society may approve other survey methods which it considers to be appropriate.</p>	

Amended-Original Requirements Comparison Table (Lifting Appliances and Anchor Handling Winches)

Amended	Original	Remarks
<p>2.4 <u>Thorough Examinations</u>*</p> <p>2.4.1 Derrick Systems</p> <p>1 At <u>thorough examinations</u>, the following items in (1) are to be visually examined for derrick systems and ascertained to be in good order. Where considered necessary by the Surveyor, the items in (2) are <u>also</u> to be examined.</p> <p>(1) Items to be examined</p> <p>(a) Structural members</p> <p>(b) <u>Connections</u> between structural members and hull structures</p> <p>(c) <u>Driving gear</u></p> <p>(d) Safety devices and protective devices</p> <p>(e) Markings of the safe working load, etc., and the effectiveness of the relevant certificates</p> <p>(f) Preservation of the instruction <u>and maintenance manuals</u> on board the ship</p> <p>(2) Items to be examined where considered necessary by the Surveyor</p> <p>(a) Checking of plate thickness of the structural members, non-destructive testing and open-up examinations of the topping brackets, goose neck brackets and derrick heel lugs</p> <p>(b) Open-up examination of the driving gear</p> <p>(c) Operation tests of the safety devices and protective devices</p> <p>2 Open-up examinations of the topping brackets, goose neck brackets and derrick heel lugs are to be carried out during <u>thorough examinations</u> at intervals not exceeding five years from the date of completion of the Registration Survey or the previous open-up examination.</p>	<p>2.4 <u>Annual Thorough Surveys</u>*</p> <p>2.4.1 Derrick Systems</p> <p>1 At <u>Annual Thorough Surveys</u>, the following items in (1) are to be visually examined for derrick systems and ascertained to be in good order. Where considered necessary by the Surveyor, the items in (2) are to be examined.</p> <p>(1) Items to be examined</p> <p>(a) Structural members</p> <p>(b) Connection between <u>the</u> structural members and hull structure</p> <p>(c) <u>Driving systems</u></p> <p>(d) Safety devices and protective devices</p> <p>(e) Markings of the safe working load, etc., and the effectiveness of the relevant certificates</p> <p>(f) Preservation of the instruction manual on board the ship</p> <p>(2) Items to be examined where considered necessary by the Surveyor</p> <p>(a) Checking of plate thickness of the structural members, non-destructive testing and open-up examinations of the topping brackets, goose neck brackets and derrick heel lugs</p> <p>(b) Open-up examination of the driving <u>systems</u></p> <p>(c) Operation tests of the safety devices and protective devices</p> <p>2 Open-up examinations of the topping brackets, goose neck brackets and derrick heel lugs are to be carried out during <u>Annual Thorough Surveys</u> at intervals not exceeding five years from the date of completion of the Registration Survey or the previous open-up examination.</p>	<p>Changes the wording to align with MSC.1/Circ.1663</p>

Amended-Original Requirements Comparison Table (Lifting Appliances and Anchor Handling Winches)

Amended	Original	Remarks
<p>2.4.2 Cranes</p> <p>At <u>thorough examinations</u>, the following items in (1) are to be visually examined for cranes and ascertained to be in good order. Where considered necessary by the Surveyor, the items in (2) are <u>also</u> to be examined.</p> <p>(1) Items to be examined</p> <p>(a) Structural members</p> <p>(b) For stationary cranes, the <u>connections</u> between structural members and hull structures</p> <p>(c) For track-mounted cranes, rails, buffers and the <u>connections</u> between those members and hull structures</p> <p>(d) Installations of driving <u>gear</u></p> <p>(e) Safety devices and protective devices</p> <p>(f) Markings of the safe working load, etc., and the effectiveness of the relevant certificates</p> <p>(g) Preservation of <u>operation and maintenance manuals</u> on board the ship</p> <p>(2) Items to be examined where considered necessary by the Surveyor</p> <p>(a) Checking of plate thickness of the structural members, non-destructive testing and open-up examinations of the bearings</p> <p>(b) Inside of the posts, their legs and stiffeners of cranes</p> <p>(c) Open-up examinations of the driving gear</p> <p>(d) Operation tests of the safety devices and protective devices</p>	<p>2.4.2 Cranes</p> <p>At <u>Annual Thorough Surveys</u>, the following items in (1) are to be visually examined for cranes and ascertained to be in good order. Where considered necessary by the Surveyor, the items in (2) are to be examined.</p> <p>(1) Items to be examined</p> <p>(a) Structural members</p> <p>(b) For stationary cranes, the connection between the structural members and hull structure</p> <p>(c) For track-mounted cranes, rails, buffers and the connection between those members and hull structure</p> <p>(d) Installations of driving <u>system</u></p> <p>(e) Safety devices and protective devices</p> <p>(f) Markings of the safe working load, etc., and the effectiveness of the relevant certificates</p> <p>(g) Preservation of <u>instruction manual</u> on board the ship</p> <p>(2) Items to be examined where considered necessary by the Surveyor</p> <p>(a) Checking of plate thickness of the structural members, non-destructive testing and open-up examinations of the bearings</p> <p>(b) Inside of the posts, their legs and stiffeners of cranes</p> <p>(c) Open-up examinations of the driving <u>gears</u></p> <p>(d) Operation tests of the safety devices and protective devices</p>	

Amended-Original Requirements Comparison Table (Lifting Appliances and Anchor Handling Winches)

Amended	Original	Remarks
<p>2.4.3 Cargo Ramps At <u>thorough examinations</u>, the items in (1) are to be visually examined for cargo ramps in detail and ascertained to be in good order. Where considered necessary by the Surveyor, the items in (2) are <u>also</u> to be examined.</p> <p>(1) Items to be examined</p> <ul style="list-style-type: none"> (a) Structural members (b) <u>C</u>onnections between structural members and hull structures (c) <u>C</u>onnections between stoppers and hull structures (d) Water-tight or weather-tight arrangements of cargo ramps that are used as water-tight or weather-tight doors when closed (e) The driving gear (f) Safety devices and protective devices (g) Markings of the safe working load and the effectiveness of the relevant certificates (h) Preservation of the <u>operation and maintenance</u> manuals on board the ship <p>(2) Items to be examined where considered necessary by the Surveyor</p> <ul style="list-style-type: none"> (a) Plate thickness measurements, open-up-inspection of lifting pins, nondestructive tests, etc. (b) Hose testing or airtight testing for cargo ramps that are used as water-tight or weather-tight doors when closed (c) Open-up examinations of the driving gear (d) Operation tests of safety devices and protective devices 	<p>2.4.3 Cargo Ramps At <u>Annual Thorough surveys</u>, the items in (1) are to be visually examined for cargo ramps in detail and ascertained to be in good order. Where considered necessary by the Surveyor, the items in (2) are to be examined.</p> <p>(1) Items to be examined</p> <ul style="list-style-type: none"> (a) Structural members (b) Connection between <u>the</u> structural members and hull structure (c) Connection between <u>the</u> stoppers and hull structure (d) Water-tight or weather-tight arrangements of cargo ramps that are used as water-tight or weather-tight doors when closed (e) The driving gears (f) Safety devices and protective devices (g) Markings of the safe working load and the effectiveness of the relevant certificates (h) Preservation of the <u>instruction</u> manuals on board the ship <p>(2) Items to be examined where considered necessary by the Surveyor</p> <ul style="list-style-type: none"> (a) Plate thickness measurements, open-up-inspection of lifting pins, nondestructive tests, etc. (b) Hose testing or airtight testing for cargo ramps that are used as water-tight or weather-tight doors when closed (c) Open-up examinations of the driving gears (d) Operation tests of safety devices and protective devices 	

Amended-Original Requirements Comparison Table (Lifting Appliances and Anchor Handling Winches)

Amended	Original	Remarks
<p>2.4.4 Cargo Lifts, etc.</p> <p>1 At <u>thorough examinations</u>, the items in (1) are to be visually examined for cargo lifts in detail and ascertained to be in good order. Where considered necessary by the Surveyor, the items in (2) are <u>also</u> to be examined.</p> <p>(1) Items to be examined</p> <ul style="list-style-type: none"> (a) Structural members (b) <u>C</u>onnections between holding parts of cargo lifts and hull structures (c) <u>C</u>onnections between lifting/lowering devices of cargo lifts and hull structures (d) Driving gear (e) Safety devices and protective devices (f) Markings of the safe working load and the effectiveness of the relevant certificates (g) Preservation of the <u>operation and maintenance</u> manuals on board the ship <p>(2) Items to be examined where considered necessary by the Surveyor</p> <ul style="list-style-type: none"> (a) Plate thickness measurements, open-up-inspection of lifting pins, nondestructive tests, etc. (b) Open-up examinations of the driving gear (c) Operation tests of the safety devices and protective devices <p>2 At <u>thorough examinations</u> for other <u>lifting</u> appliances used for loading and unloading of cargoes and other articles, they are to be visually examined and ascertained to be in good order. When considered necessary by the Surveyor, a further examination may be carried out.</p>	<p>2.4.4 Cargo Lifts, etc.</p> <p>1 At <u>Annual Thorough surveys</u>, the items in (1) are to be visually examined for cargo lifts in detail and ascertained to be in good order. Where considered necessary by the Surveyor, the items in (2) are to be examined.</p> <p>(1) Items to be examined</p> <ul style="list-style-type: none"> (a) Structural members (b) Connection between <u>the</u> holding parts of cargo lifts and hull structure (c) Connection between <u>the</u> lifting/lowering devices of cargo lifts and hull structure (d) Driving gears (e) Safety devices and protective devices (f) Markings of the safe working load and the effectiveness of the relevant certificates (g) Preservation of the <u>instruction</u> manuals on board the ship <p>(2) Items to be examined where considered necessary by the Surveyor</p> <ul style="list-style-type: none"> (a) Plate thickness measurements, open-up-inspection of lifting pins, nondestructive tests, etc. (b) Open-up examinations of the driving gears (c) Operation tests of the safety devices and protective devices <p>2 At <u>Annual Thorough Surveys</u> for other <u>cargo handling</u> appliances used for loading and unloading of cargoes and other articles, they are to be visually examined and ascertained to be in good order. When considered necessary by the Surveyor, a further examination may be carried out.</p>	

Amended-Original Requirements Comparison Table (Lifting Appliances and Anchor Handling Winches)

Amended	Original	Remarks
<p>2.4.5 Loose Gear</p> <p>At <u>thorough examinations</u>, the following items in (1) to (3) of loose gear is to be visually examined and ascertained to be in good order. However, where considered necessary by the Surveyor, the items in (2) are to be opened up and examined.</p> <p>(1) Wires for their full length</p> <p>(2) Cargo blocks, chains, rings, hooks, shackles, swivels, lifting beams, cramps, rigging screw, grabs, lifting magnets, spreaders, etc.</p> <p>(3) Markings of the safe working load and identification symbols, and the effectiveness of the relevant certificates</p> <p>(Deleted)</p>	<p>2.4.5 Loose Gears</p> <p>1 At <u>Annual Thorough Surveys</u>, the following items in (1) through (3) of loose gears are to be visually examined and ascertained to be in good order. However, where considered necessary by the Surveyor, the items in (2) are to be opened up and examined.</p> <p>(1) <u>Wire ropes</u> for their full length</p> <p>(2) Cargo blocks, chains, rings, hooks, shackles, swivels, lifting beams, cramps, rigging screw, grabs, lifting magnets, spreaders, etc.</p> <p>(3) Markings of the safe working load and identification symbols, and the effectiveness of the relevant certificates</p> <p>2 In case where some of loose gears need to be repaired or renewed at times other than at the Periodical Surveys, the Society may accept an autonomous inspection carried out by ship's master or his representative. In this case, the personnel who carried out an autonomous inspection is to record the following (1) through (6) for the loose gears renewed in the Inspection Record Book of Loose Gear (Part II), and show this Inspection Record Book and the certificates of the loose gears concerned to the Surveyor for his approval at the next Periodical Survey or Occasional Survey.</p> <p>(1) Names and identification symbols</p> <p>(2) Locations in service</p> <p>(3) Safe working loads</p> <p>(4) Testing loads</p> <p>(5) Dates of renewal or repairs and dates of commencement of use</p> <p>(6) Reasons for renewal or repairs</p>	

Amended-Original Requirements Comparison Table (Lifting Appliances and Anchor Handling Winches)

Amended	Original	Remarks
<p>2.5 Load Tests</p> <p>2.5.1 Load Tests*</p> <p>1 At <u>load tests</u>, <u>lifting appliances and loose gear</u> are to be examined by applying movable weights or loads at least equal to the test loads as specified in -2 and in the manners specified in -4 or -5 depending on the types of <u>lifting appliances</u> and ascertained that they are in good order. <u>For lifting appliances intended for open-sea operations, the test loads are to be to the satisfaction of the Administration which is recognised by it, taking into account the applicable dynamic loads.</u> However, <u>load tests</u> of loose gear may be replaced with tests conducted by manufacturers (i.e. <u>proof tests</u>) provided that the certificates with testing records of them are submitted.</p> <p>2 The test loads used for <u>load tests</u> are to comply with the requirements of the following (1) to (3) depending on the types of <u>lifting appliances and loose gear</u>:</p> <p>(1) The test loads for of <u>lifting appliances</u> are to be as given in Table 2.1 according to the safe working loads;</p> <p>(2) The test loads for loose gear except for ropes are to be as given in Table 2.2 according to the safe working loads;</p> <p>(3) The test loads for ropes are to satisfy the following formula: $T \geq W \cdot f$ where, T: Test loads for ropes (t) W: Safe working loads of ropes (t) f: Safety factors specified in 6.3.1(5) or 6.3.2(3)</p>	<p>2.5 Load Tests</p> <p>2.5.1 Load Tests*</p> <p>1 At <u>Load Tests</u>, <u>cargo handling appliances</u> are to be examined by applying movable weights or loads at least equal to the test loads as specified in -2 and in the manners specified in -3 or -4 depending on the types of <u>cargo handling appliances</u> and ascertained that they are in good order. However, <u>Load Tests</u> of loose gears may be replaced with tests conducted by manufacturers provided that the certificates with testing records of them are submitted.</p> <p>2 The test loads used for <u>Load Tests</u> are to comply with the requirements of the following (1) through (3) depending on the types of cargo handling appliances:</p> <p>(1) The test loads for <u>cargo gears and cargo ramps</u> are to be as given in Table 2.1 according to the safe working loads;</p> <p>(2) The test loads for loose gears except for ropes are to be as given in Table 2.2 according to the safe working loads;</p> <p>(3) The test loads for ropes are to satisfy the following formula: $T \geq W \cdot f$ where, T: Test loads for ropes (t) W: Safe working loads of ropes (t) f: Safety factors specified in 6.3.1(5) or 6.3.2(3)</p>	<p>MSC.1/Circ.1663 Para.3.2.1.5</p>

Amended-Original Requirements Comparison Table (Lifting Appliances and Anchor Handling Winches)

Amended	Original	Remarks																									
<p>3 Where the safe working load of the lifting appliances is undocumented and design information is not available (e.g. for lifting appliances installed on board before 1 January 2026 for which the manufacturer no longer exists), test loads are to be calculated using Table 2.1, based on a safe working load declared by the ship’s owner or management company, to the satisfaction of the Administration.</p>	<p>(Newly added)</p>	<p>MSC.1/Circ.1663 Para.3.2.1.6</p>																									
<p>Table 2.1 Test Load for Cargo Gear and Cargo Ramps Lifting Appliances</p>																											
<table border="1" style="width: 100%; border-collapse: collapse;"> <thead> <tr> <th style="width: 50%;">Safe working load <i>SWL</i> (t)</th> <th style="width: 50%;">Test load (t)</th> </tr> </thead> <tbody> <tr> <td>$SWL < \leq 20$</td> <td>$1.25 \times SWL$</td> </tr> <tr> <td>$20 \leq \leq SWL \leq 50$</td> <td>$SWL + 5$</td> </tr> <tr> <td>$50 \leq \leq SWL \leq 100$</td> <td>$1.1 \times SWL$</td> </tr> <tr> <td>$100 \leq SWL$</td> <td>Load as considered appropriate by the Society</td> </tr> </tbody> </table>			Safe working load <i>SWL</i> (t)	Test load (t)	$SWL < \leq 20$	$1.25 \times SWL$	$20 \leq \leq SWL \leq 50$	$SWL + 5$	$50 \leq \leq SWL \leq 100$	$1.1 \times SWL$	$100 \leq SWL$	Load as considered appropriate by the Society															
Safe working load <i>SWL</i> (t)	Test load (t)																										
$SWL < \leq 20$	$1.25 \times SWL$																										
$20 \leq \leq SWL \leq 50$	$SWL + 5$																										
$50 \leq \leq SWL \leq 100$	$1.1 \times SWL$																										
$100 \leq SWL$	Load as considered appropriate by the Society																										
<p>Table 2.2 Test Loads for Loose Gears</p>																											
<table border="1" style="width: 100%; border-collapse: collapse;"> <thead> <tr> <th style="width: 30%;">Article of Gear</th> <th style="width: 35%;">Safe Working Load (<i>SWL</i>) (t)</th> <th style="width: 35%;">Test Load (t)</th> </tr> </thead> <tbody> <tr> <td rowspan="4" style="text-align: center; vertical-align: middle;">Pulley blocks</td> <td>Single-sheave block ¹ without becket</td> <td style="text-align: center;">—</td> </tr> <tr> <td>Single sheave block with becket</td> <td style="text-align: center;">—</td> </tr> <tr> <td rowspan="2" style="text-align: center; vertical-align: middle;">Multi-sheave block ²(including hook blocks ³)</td> <td style="text-align: center;">$SWL \leq 25$</td> <td style="text-align: center;">$2 \times SWL$</td> </tr> <tr> <td style="text-align: center;">$25 < SWL \leq 160$</td> <td style="text-align: center;">$(0.933 \times SWL) + 27$</td> </tr> <tr> <td rowspan="3" style="text-align: center; vertical-align: middle;">Chain hook ³, shackle, ring, link, swivel, clamp and similar gear</td> <td style="text-align: center;">$SWL \leq 25$</td> <td style="text-align: center;">$2 \times SWL$</td> </tr> <tr> <td style="text-align: center;">$25 < SWL$</td> <td style="text-align: center;">$(1.22 \times SWL) + 20$</td> </tr> <tr> <td style="text-align: center;">$SWL \leq 10$</td> <td style="text-align: center;">$2 \times SWL$</td> </tr> <tr> <td rowspan="2" style="text-align: center; vertical-align: middle;">Lifting beam, Lifting magnet, spreader and similar gear</td> <td style="text-align: center;">$10 < SWL \leq 160$</td> <td style="text-align: center;">$(1.04 \times SWL) + 9.6$</td> </tr> <tr> <td style="text-align: center;">$160 < SWL$</td> <td style="text-align: center;">$1.1 \times SWL$</td> </tr> </tbody> </table>			Article of Gear	Safe Working Load (<i>SWL</i>) (t)	Test Load (t)	Pulley blocks	Single-sheave block ¹ without becket	—	Single sheave block with becket	—	Multi-sheave block ² (including hook blocks ³)	$SWL \leq 25$	$2 \times SWL$	$25 < SWL \leq 160$	$(0.933 \times SWL) + 27$	Chain hook ³ , shackle, ring, link, swivel, clamp and similar gear	$SWL \leq 25$	$2 \times SWL$	$25 < SWL$	$(1.22 \times SWL) + 20$	$SWL \leq 10$	$2 \times SWL$	Lifting beam, Lifting magnet, spreader and similar gear	$10 < SWL \leq 160$	$(1.04 \times SWL) + 9.6$	$160 < SWL$	$1.1 \times SWL$
Article of Gear	Safe Working Load (<i>SWL</i>) (t)	Test Load (t)																									
Pulley blocks	Single-sheave block ¹ without becket	—																									
	Single sheave block with becket	—																									
	Multi-sheave block ² (including hook blocks ³)	$SWL \leq 25$	$2 \times SWL$																								
		$25 < SWL \leq 160$	$(0.933 \times SWL) + 27$																								
Chain hook ³ , shackle, ring, link, swivel, clamp and similar gear	$SWL \leq 25$	$2 \times SWL$																									
	$25 < SWL$	$(1.22 \times SWL) + 20$																									
	$SWL \leq 10$	$2 \times SWL$																									
Lifting beam, Lifting magnet, spreader and similar gear	$10 < SWL \leq 160$	$(1.04 \times SWL) + 9.6$																									
	$160 < SWL$	$1.1 \times SWL$																									
<p>Notes:</p> <ol style="list-style-type: none"> 1. The <i>SWL</i> for a single sheave block, including single sheave blocks with becketts, is to be taken as one half of the resultant load on the head fitting 2. The <i>SWL</i> of a multi-sheave block is to be taken as the resultant load on the head fitting. 3. .Sheave blocks that are permanently attached to, or are integral with the hook, are called hook blocks. Hook blocks are to be tested with the load for multi-sheave blocks. The hook of the hook block is to be tested with the loads for hooks. 																											
		<p>MSC.1/Circ.1663 Table 1</p> <p>Amends to align with MSC.1/Circ.1663 Table 2</p>																									

Amended-Original Requirements Comparison Table (Lifting Appliances and Anchor Handling Winches)

Amended	Original	Remarks
<p>4 For <u>lifting appliances and loose gear</u> of which the safe working loads, etc. are assigned for the first time, the methods of load tests are to comply with the following requirements in (1) through (5):</p> <p>(1) Derrick systems</p> <p>(a) In case of a swinging derrick system, the test weight is to be slewed throughout the working range at the allowable minimum angle and then lifted/lowered at some position of the working range.</p> <p>(b) In case of a derrick crane, in addition to (a), the derrick boom is to be luffed with suspending the test weight at the position of outreach and ship's centre line.</p> <p>(c) In case of a union-purchase derrick system, the test weight is to be manoeuvred throughout the working range within the allowable lifting height or the maximum angle between two cargo falls specified in 9.2.3.</p> <p>(2) Cranes</p> <p>(a) In case of a jib crane, the test weight is to be slewed throughout the working range at the maximum slewing radius and then lifted/lowered at some position of the working range. Further, jib is to be luffed at some position of the working range.</p> <p>(b) In case of track-mounted cranes, the crane with the test weight suspended is to be transversesed throughout the working range and test weight is to be lifted/lowered at some position.</p> <p>(c) In case of track-mounted hoisting gear, the hoisting gear suspending the test weight is to be traversed from one end of the bridge span to the</p>	<p>3 For <u>cargo handling appliances</u> of which the safe working loads, etc. are assigned for the first time, the methods of load tests are to comply with the following requirements in (1) through (5):</p> <p>(1) Derrick systems</p> <p>(a) In case of a swinging derrick system, the test weight is to be slewed throughout the working range at the allowable minimum angle and then lifted/lowered at some position of the working range.</p> <p>(b) In case of a derrick crane, in addition to (a), the derrick boom is to be luffed with suspending the test weight at the position of outreach and ship's centre line.</p> <p>(c) In case of a union-purchase derrick system, the test weight is to be manoeuvred throughout the working range within the allowable lifting height or the maximum angle between two cargo falls specified in 9.2.3.</p> <p>(2) Cranes</p> <p>(a) In case of a jib crane, the test weight is to be slewed throughout the working range at the maximum slewing radius and then lifted/lowered at some position of the working range. Further, jib is to be luffed at some position of the working range.</p> <p>(b) In case of <u>a</u> track-mounted cranes, the crane with the test weight suspended is to be transversesed throughout the working range and test weight is to be lifted/lowered at some position.</p> <p>(c) In case of <u>a</u> track-mounted hoisting gear, the hoisting gear <u>with</u> suspending the test weight is to be traversed from one end of the bridge span to</p>	

Amended-Original Requirements Comparison Table (Lifting Appliances and Anchor Handling Winches)

Amended	Original	Remarks
<p>other and the test weight is to be lifted/lowered at some position.</p> <p>(3) Cargo lifts In case of a cargo lift, the test weight is to be so spaced that the most severe working condition is available taking into account one side loading, and the cargo lift is to be moved between each stop position, and to be lifted or lowered within the entire stroke of motion.</p> <p>(4) Cargo ramps In case of a cargo ramp, the test weight is to be placed on the severest position of loading in the designed loading conditions, and the deflection is to be measured. As far as practicable, a vehicle with the mass corresponding to the safe working load is to run on the cargo ramp.</p> <p>(5) <u>In case of lifting appliances located below deck, the load test may be carried out using a weighing machine anchored suitably and safely in accordance with the method considered appropriate by the Society in place of (1) to (4) above.</u></p> <p>(6) In case of loose gear, the test load is to be loaded in the method considered as appropriate by the Society.</p> <p>5 For <u>lifting appliances and loose gear</u> other than those described in <u>-4 above</u>, the methods of load tests are to comply with the following requirements in (1) or (2).</p> <p>(1) The load test specified in <u>-4 above</u> is to be carried out.</p> <p>(2) The load test may be carried out using a weighing machine anchored suitably and safely in accordance with the method considered appropriate by the Society.</p>	<p>the other and the test weight is to be lifted/lowered at some position.</p> <p>(3) Cargo lifts In case of a cargo lift, the test weight is to be so spaced that the most severe working condition is available taking into account one side loading, and the cargo lift is to be moved between each stop position, and to be lifted or lowered within the entire stroke of motion.</p> <p>(4) Cargo ramps In case of a cargo ramp, the test weight is to be placed on the severest position of loading in the designed loading conditions, and the deflection is to be measured. As far as practicable, a vehicle with the mass corresponding to the safe working load is to run on the cargo ramp.</p> <p>(5) In case of loose gear, the test load is to be loaded in the method considered as appropriate by the Society.</p> <p>4 For <u>the cargo handling appliances</u> other than described in <u>-3</u>, the methods of load tests are to comply with the following requirements in (1) or (2).</p> <p>(1) The load test specified in <u>-3(1), (2), (3), or (4)</u> is to be carried out.</p> <p>(2) The load test may be carried out using a <u>spring or hydraulic</u> weighing machine anchored suitably and safely in accordance with the method considered appropriate by the Society.</p>	<p>Specifies alternative load test method for lifting appliances located below deck</p>

Amended-Original Requirements Comparison Table (Lifting Appliances and Anchor Handling Winches)

Amended	Original	Remarks
<p><u>2.6 Records of Thorough Examinations and Tests</u></p> <p><u>2.6.1 Lifting Appliances</u></p> <p><u>1 Records of thorough examinations and load tests are to be maintained in the “Register of Ship’s Lifting Appliances and Loose Gear” and are to be available on board.</u></p> <p><u>2 Records of thorough examinations and load tests are to be in formats deemed appropriate by the Society and are to include, at a minimum, the information listed on the “Certificate of Test and Thorough Examination”, as specified in 9.4.1(2) to (5). Alternatively, other formats may be used when deemed acceptable by the Administration.</u></p> <p><u>2.6.2 Loose Gear</u></p> <p><u>1 Records of thorough examinations and proof tests are to be maintained in the “Register of Ship’s Lifting Appliances and Loose Gear” and are to be available on board.</u></p> <p><u>2 Records of thorough examinations and proof tests are to be in formats deemed appropriate by the Society and are to include, at a minimum, the information listed on the “Certificate of Test and Thorough Examination of Loose Gear (ILO Form 3) (CG.4)”, as specified in 9.4.1(6). Alternatively, other formats may be used when deemed acceptable by the Administration.</u></p>	<p>(Newly added)</p>	<p>MSC.1/Circ.1663 Para.3.2.3, Para.4.7.1</p> <p>MSC.1/Circ.1663 Para.3.2.3.1</p> <p>MSC.1/Circ.1663 Para.3.2.3.2</p> <p>MSC.1/Circ.1663 Para.4.7.1.1</p> <p>MSC.1/Circ.1663 Para.4.7.1.2</p>

Amended-Original Requirements Comparison Table (Lifting Appliances and Anchor Handling Winches)

Amended	Original	Remarks
<p align="center">Chapter 3 DERRICK SYSTEMS</p> <p>3.1 General</p> <p>3.1.1 Application (Same)</p> <p>3.2 Design Loads</p> <p>3.2.1 Load Considerations* (Same)</p> <p>3.2.2 Friction of Cargo Blocks (Same)</p>	<p align="center">Chapter 3 DERRICK SYSTEMS</p> <p>3.1 General</p> <p>3.1.1 Application The requirements in this Chapter apply to the structural members of derrick systems.</p> <p>3.2 Design Loads</p> <p>3.2.1 Load Considerations* The loads to be taken into the calculations of dimensions of the structural members are to be as specified in (1) through (7) below:</p> <ol style="list-style-type: none"> (1) Safe working load of the derrick systems (2) Self-weight of derrick boom and cargo fittings attached thereto (3) Self-weight of loose gear (4) Friction of cargo blocks (5) Loads due to ship inclination (6) Wind loading (7) Other loads considered to be necessary by the Society <p>3.2.2 Friction of Cargo Blocks In calculating the load at the rope end, the following friction load coefficients are to be taken into account depending on the types of bearing:</p> <p style="padding-left: 40px;">Bush bearing: 0.05 Roller bearing: 0.02</p>	

Amended-Original Requirements Comparison Table (Lifting Appliances and Anchor Handling Winches)

Amended	Original	Remarks
<p>3.2.3 Load due to Ship Inclination* (Same)</p>	<p>3.2.3 Load due to Ship Inclination* The angles of inclination used for the calculation of the loads due to ship inclination are to be the angles expected to occur in service condition, but they are not to be taken as less than 5° in angle of heel and 2° in angle of trim. If data on the angles of inclination of the ship concerned are submitted and recognized as appropriate by the Society, however, these angles may be used in the calculations.</p>	
<p>3.2.4 Wind Loading (Same)</p>	<p>3.2.4 Wind Loading Wind loading is to be calculated according to 4.2.5; however, the lower limit of the design wind velocity in the stowage condition is to be taken as “50 <i>m/sec</i>” instead of “55 <i>m/sec</i>”.</p>	
<p>3.2.5 Load Combinations (Same)</p>	<p>3.2.5 Load Combinations 1 The load to be used in the strength analysis of the structural members is to be such a combined load that these members may be put in the most severe load condition considering the loads specified in 3.2.1. 2 The union-purchase derrick system is to be analyzed as a swinging derrick system and a union-purchase derrick system respectively using the combined load according to the requirement in -1.</p>	
<p>(Same)</p>		

Amended-Original Requirements Comparison Table (Lifting Appliances and Anchor Handling Winches)

Amended	Original	Remarks
<p>3.3 Strength and Construction of Derrick Posts, Masts, Derrick Booms and Stays</p> <p>3.3.1 Strength Analysis (Same)</p> <p>(Same)</p> <p>3.3.2 Allowable Stress for Combined Loads (Same)</p>	<p>3.3 Strength and Construction of Derrick Posts, Masts, Derrick Booms and Stays</p> <p>3.3.1 Strength Analysis</p> <p>1 The strength of derrick posts, masts (hereinafter referred to as “posts”), derrick booms and stays are to be analyzed for the combined load specified in 3.2.5 to determine the dimensions of their members in accordance with the requirement in 3.3.2, 3.3.3, 3.3.5, 3.3.6 and 3.3.7.</p> <p>2 The Young’s modulus of the wire ropes to be used in the analysis of strength of stayed posts is to be 30.4 kN/mm^2 and 45.1 kN/mm^2 for the case of determining the dimensions of posts and stays respectively.</p> <p>3.3.2 Allowable Stress for Combined Loads</p> <p>1 The combined stress of derrick posts and derrick booms calculated by the following formula on the basis of the compressive stress due to bending moment, the compressive stress due to axial compression and the shearing stress due to twisting of the member is not to exceed the allowable stress σ_a given in either Table 3.1 or Table 3.2.</p> $\sqrt{(\sigma_b + \sigma_c)^2 + 3\tau^2} \text{ (N/mm}^2\text{)}$ <p>where</p> <p>σ_b : Compressive stress due to bending moment (N/mm^2)</p> <p>σ_c : Compressive stress due to axial compression (N/mm^2)</p> <p>τ : Shearing stress due to twisting of member (N/mm^2)</p>	

Amended-Original Requirements Comparison Table (Lifting Appliances and Anchor Handling Winches)

Amended	Original	Remarks												
<p>Table 3.1 Allowable Stress σ_a (for derrick posts)</p> <table border="1"> <thead> <tr> <th align="center">Safe working load W (t)</th> <th align="center">Allowable stress σ_a (N/mm²)</th> </tr> </thead> <tbody> <tr> <td align="center">$W < 10$</td> <td align="center">$0.50\sigma_y$</td> </tr> <tr> <td align="center">$10 \leq W < 15$</td> <td align="center">$(0.016W + 0.34)\sigma_y$</td> </tr> <tr> <td align="center">$15 \leq W < 50$</td> <td align="center">$0.58\sigma_y$</td> </tr> <tr> <td align="center">$50 \leq W < 60$</td> <td align="center">$(0.005W + 0.33)\sigma_y$</td> </tr> <tr> <td align="center">$60 \leq W$</td> <td align="center">$0.63\sigma_y$</td> </tr> </tbody> </table> <p>Note: σ_y : The yield point or proof stress of material (N/mm²)</p>		Safe working load W (t)	Allowable stress σ_a (N/mm ²)	$W < 10$	$0.50\sigma_y$	$10 \leq W < 15$	$(0.016W + 0.34)\sigma_y$	$15 \leq W < 50$	$0.58\sigma_y$	$50 \leq W < 60$	$(0.005W + 0.33)\sigma_y$	$60 \leq W$	$0.63\sigma_y$	No change
Safe working load W (t)	Allowable stress σ_a (N/mm ²)													
$W < 10$	$0.50\sigma_y$													
$10 \leq W < 15$	$(0.016W + 0.34)\sigma_y$													
$15 \leq W < 50$	$0.58\sigma_y$													
$50 \leq W < 60$	$(0.005W + 0.33)\sigma_y$													
$60 \leq W$	$0.63\sigma_y$													
<p>Table 3.2 Allowable Stress σ_a (for derrick booms)</p> <table border="1"> <thead> <tr> <th align="center">Safe working load W (t)</th> <th align="center">Allowable stress σ_a (N/mm²)</th> </tr> </thead> <tbody> <tr> <td align="center">$W < 10$</td> <td align="center">$0.34\sigma_y$</td> </tr> <tr> <td align="center">$10 \leq W < 15$</td> <td align="center">$(0.018W + 0.16)\sigma_y$</td> </tr> <tr> <td align="center">$15 \leq W$</td> <td align="center">$0.43\sigma_y$</td> </tr> </tbody> </table> <p>Note: σ_y : The yield point or proof stress of material (N/mm²)</p>		Safe working load W (t)	Allowable stress σ_a (N/mm ²)	$W < 10$	$0.34\sigma_y$	$10 \leq W < 15$	$(0.018W + 0.16)\sigma_y$	$15 \leq W$	$0.43\sigma_y$	No change				
Safe working load W (t)	Allowable stress σ_a (N/mm ²)													
$W < 10$	$0.34\sigma_y$													
$10 \leq W < 15$	$(0.018W + 0.16)\sigma_y$													
$15 \leq W$	$0.43\sigma_y$													
<p>2 The tension of the ropes used for stay is not to exceed the value obtained by dividing the value of breaking strength specified in Table L4.3, Part L of the Rules for the Survey and Construction of Steel Ships by the safety factor specified in 6.3.1(5).</p> <p>3.3.3 Minimum Plate Thickness of Posts (Same)</p> <p>3.3.4 Construction of Posts (Same)</p>	<p>2 The tension of the <u>wire</u> ropes used for stay is not to exceed the value obtained by dividing the value of breaking strength specified in Table L4.3, Part L of the Rules for the Survey and Construction of Steel Ships by the safety factor specified in 6.3.1(5).</p> <p>3.3.3 Minimum Plate Thickness of Posts The plate thickness of posts is not to be less than 6 mm.</p> <p>3.3.4 Construction of Posts 1 The lower part of the post is to be effectively connected to hull structures by any of the following methods (1), (2) or (3), or any other method approved as appropriate by the Society: (1) To be supported by two or more superposed decks (2) To be supported by deckhouse of an enough strength (3) To be supported by bulkhead for an ample depth</p>													

Amended-Original Requirements Comparison Table (Lifting Appliances and Anchor Handling Winches)

Amended	Original	Remarks
(Same)	<p>beneath the deck</p> <p>2 The post well below the base to well above the goose neck bracket is to be of the dimensions equivalent to that at the base as far as practicable.</p>	
(Same)	<p>3 The post is to be locally reinforced by the use of thicker plating, doubling plates, additional reinforcing members, etc. in the connection of post body and portal beam, the parts where the goose neck brackets and topping brackets are fitted, etc. and the parts where stress concentration expected.</p>	
(Same)	<p>4 At the ends of the upper portal, its depth and plate thickness are to be properly increased. When opening hole at the end of the upper portal is unavoidably provided, properly reinforcement is to be provided around the opening hole.</p>	
<p>3.3.5 Buckling Strength (Same)</p>	<p>3.3.5 Buckling Strength For member subjected to compression, the value obtained from the following formula is not to exceed the allowable stress σ_a given in either Table 3.1 or Table 3.2.</p> $1.15\omega\sigma_a \text{ (N/mm}^2\text{)}$ <p>where</p> <p>σ_c: Axial compressive stress (N/mm²) ω : Coefficient calculated by the formula in Table 3.3(a) for the slenderness ratio and type of the member concerned</p>	

Amended-Original Requirements Comparison Table (Lifting Appliances and Anchor Handling Winches)

Amended	Original	Remarks	
Table 3.3(a) Formulae for ω		No change	
Relation of λ and λ_0	Type of member		Formulae for ω
$\lambda \geq \lambda_0$	All members		$2.9 \left(\frac{\lambda}{\lambda_0} \right)^2$
$\lambda < \lambda_0$	Plate members		$\frac{1 + 0.45(\lambda/\lambda_0)}{1 - 0.5(\lambda/\lambda_0)^2}$
	Cylindrical members	$\frac{0.87 + 0.46(\lambda/\lambda_0) + 0.12(\lambda/\lambda_0)^2}{1 - 0.5(\lambda/\lambda_0)^2}$	
<p>Notes:</p> <p>1. λ is the slenderness ratio of the member subjected to compression to be obtained from the following formula:</p> $l_e \sqrt{\frac{A}{I}}$ <p>where</p> <p>A : Sectional area of the member (m^2)</p> <p>I : Moment of inertia of section of member (m^4)</p> <p>l_e : Effective length of the member to be determined as the product of the actual length of the member and coefficient K obtained from the following Table 3.3(b) for respective end conditions (m)</p> <p>2. λ_0 is the value obtained from the following formula:</p> $\sqrt{\frac{2\pi^2 E}{\sigma_y}}$ <p>where</p> <p>π : The circular constant</p> <p>E : Young's modulus (N/mm^2)</p> <p>σ_y : Specified yield stress of material (N/mm^2)</p>			

Amended-Original Requirements Comparison Table (Lifting Appliances and Anchor Handling Winches)

Amended	Original	Remarks																													
<p>Table 3.3(b) Values of K</p> <table border="1" style="margin: auto; border-collapse: collapse;"> <thead> <tr> <th rowspan="2" style="text-align: center;">Another end</th> <th colspan="4" style="text-align: center;">One end</th> </tr> <tr> <th style="text-align: center;"><i>R</i>: con. <i>D</i>: con.</th> <th style="text-align: center;"><i>R</i>: con. <i>D</i>: free</th> <th style="text-align: center;"><i>R</i>: free <i>D</i>: con.</th> <th style="text-align: center;"><i>R</i>: free <i>D</i>: free</th> </tr> </thead> <tbody> <tr> <td style="text-align: center;"><i>R</i>: con. <i>D</i>: con.</td> <td style="text-align: center;">0.5</td> <td style="text-align: center;">1.0</td> <td style="text-align: center;">0.7</td> <td style="text-align: center;">2.0</td> </tr> <tr> <td style="text-align: center;"><i>R</i>: con. <i>D</i>: free</td> <td style="text-align: center;">1.0</td> <td style="text-align: center;">-</td> <td style="text-align: center;">2.0</td> <td style="text-align: center;">-</td> </tr> <tr> <td style="text-align: center;"><i>R</i>: free <i>D</i>: con.</td> <td style="text-align: center;">0.7</td> <td style="text-align: center;">2.0</td> <td style="text-align: center;">1.0</td> <td style="text-align: center;">-</td> </tr> <tr> <td style="text-align: center;"><i>R</i>: free <i>D</i>: free</td> <td style="text-align: center;">2.0</td> <td style="text-align: center;">-</td> <td style="text-align: center;">-</td> <td style="text-align: center;">-</td> </tr> </tbody> </table>		Another end	One end				<i>R</i> : con. <i>D</i> : con.	<i>R</i> : con. <i>D</i> : free	<i>R</i> : free <i>D</i> : con.	<i>R</i> : free <i>D</i> : free	<i>R</i> : con. <i>D</i> : con.	0.5	1.0	0.7	2.0	<i>R</i> : con. <i>D</i> : free	1.0	-	2.0	-	<i>R</i> : free <i>D</i> : con.	0.7	2.0	1.0	-	<i>R</i> : free <i>D</i> : free	2.0	-	-	-	No change
Another end	One end																														
	<i>R</i> : con. <i>D</i> : con.	<i>R</i> : con. <i>D</i> : free	<i>R</i> : free <i>D</i> : con.	<i>R</i> : free <i>D</i> : free																											
<i>R</i> : con. <i>D</i> : con.	0.5	1.0	0.7	2.0																											
<i>R</i> : con. <i>D</i> : free	1.0	-	2.0	-																											
<i>R</i> : free <i>D</i> : con.	0.7	2.0	1.0	-																											
<i>R</i> : free <i>D</i> : free	2.0	-	-	-																											
<p>Note: <i>R</i> : Rotation <i>D</i> : Displacement con.: constrained</p>																															
<p>3.3.6 Combined Compressive Stress (Same)</p>	<p>3.3.6 Combined Compressive Stress The compressive stress due to combination of the compressive stress due to axial compression and that due to bending moment is to meet the following formula:</p> $\frac{\sigma_c}{\sigma_{ca}} + \frac{\sigma_b}{\sigma_a} \leq 1.0$ <p>where</p> <ul style="list-style-type: none"> σ_a : Allowable bending stress corresponding to the safe working load <i>W</i> given in either Table 3.1 or Table 3.2 (<i>N/mm²</i>) σ_{ca} : Allowable compressive stress to be taken as a quotient of σ_a divided 1.15 (<i>N/mm²</i>) σ_b : Compressive stress due to bending moment (<i>N/mm²</i>) σ_c : Compressive stress due to axial compression (<i>N/mm²</i>) 																														

Amended-Original Requirements Comparison Table (Lifting Appliances and Anchor Handling Winches)

Amended	Original	Remarks
<p>3.3.7 Minimum Plate Thickness of Derrick Booms (Same)</p>	<p>3.3.7 Minimum Plate Thickness of Derrick Booms The plate thickness used for the body of derrick booms is not to be less than 2% of the outside diameter at middle of the effective length or the boom or 6 mm, whichever is the greater.</p>	
<p>3.3.8 Reinforcement of Derrick Booms (Same)</p> <p>(Same)</p>	<p>3.3.8 Reinforcement of Derrick Booms 1 The plating at the head of the derrick booms to which fittings are attached is to be provided with doubling plates or reinforced by other suitable means. 2 Where cargo fittings for whipped rigging are attached to the boom, proper reinforcement is to be made by doubling plates or other suitable means.</p>	
<p>3.3.9 Derrick Boom Stopper for Dropping out (Same)</p>	<p>3.3.9 Derrick Boom Stopper for Dropping out Derrick booms are to be supported by a goose neck bracket and to be safeguarded against dropping out of their sockets or supports.</p>	
<p>3.3.10 Effective Slenderness Ratio (Same)</p>	<p>3.3.10 Effective Slenderness Ratio The slenderness ratios of derrick posts, masts, derrick booms or other members subject to compression are to be not more than 150.</p>	
<p>3.3.11 Ensuring stiffness (Same)</p>	<p>3.3.11 Ensuring stiffness The stiffness of the main structural parts of a derrick is to be ensured to prevent any deformation that may interfere with the use of the derrick.</p>	

Amended-Original Requirements Comparison Table (Lifting Appliances and Anchor Handling Winches)

Amended	Original	Remarks
<p>3.4 Simplified Calculation Method for Post and Stays of Swinging Derrick Systems</p> <p>3.4.1 Application (Same)</p> <p>3.4.2 Diameter of Post at the Base (Same)</p> <p>3.4.3 Section Modulus of Post at the Base (Same)</p>	<p>3.4 Simplified Calculation Method for Post and Stays of Swinging Derrick Systems</p> <p>3.4.1 Application Notwithstanding the provisions in 3.3.1, 3.3.2, 3.3.3, 3.3.5 and 3.3.6, the dimensions of posts and stays of swinging derrick systems may be determined according to the requirements in 3.4.</p> <p>3.4.2 Diameter of Post at the Base The outside diameter of post at the base is not to be less than the value obtained from the following formula. For elliptic or oval section, its minor diameter is to be regarded as the outside diameter, while the short side is to be regarded as the outside diameter for rectangular cross section. $5h$ (cm) where h : Vertical distance from the base of post to the topping bracket (m)</p> <p>3.4.3 Section Modulus of Post at the Base 1 The section modulus of unstayed posts at the base is not to be less than the value obtained according to (1) through (3) below depending upon the arrangement of derrick booms. (1) When a derrick boom is fitted on either of forward or aftward side of the post, the section modulus is to be the value obtained from the following formula: $C_1 C_2 \rho W$ (cm³) where W : Safe working load (t) ρ : Slewing radius at the allowable minimum angle (m)</p>	

Amended-Original Requirements Comparison Table (Lifting Appliances and Anchor Handling Winches)

Amended	Original	Remarks
	<p>C_1 and C_2 : Coefficients obtained from Table 3.4 For intermediate values of W, the coefficients C_1 and C_2 are to be obtained by interpolation.</p> <p>(2) The section modulus about the axis parallel to the longitudinal direction of the ship is to be the value obtained from (1) or the value obtained from the following formula, whichever is the greater, when two derrick booms are fitted on both the forward and aftward the post.</p> $\sum C_2 W u \text{ (cm}^3\text{)}$ <p>where</p> $\sum C_2 W$: Sum of $C_2 W$ for derrick booms situated forward and aftward the post respectively Where C_2 and W are those obtained from (1) <p>u : Distance from the center of the post to the side of the ship, plus the outreach (m)</p> <p>(3) Where derrick booms are supported by an independent structure other than the post, the section modulus is not to be less than obtained from the formula in (1) and (2), multiplied by the value obtained from the following formula. In this case, the coefficient C_1 in the formula specified in (1) is to be taken as 1.0.</p> $\frac{h}{h - h'}$ <p>where</p> <p>h' : Vertical distance from the base of the post to the center of horizontal pin of the goose neck bracket</p> <p>h : As specified in 3.4.2</p>	

Amended-Original Requirements Comparison Table (Lifting Appliances and Anchor Handling Winches)

Amended	Original	Remarks																														
<p>Table 3.4 Values of C_1 and C_2</p> <table border="1" style="margin:auto; border-collapse: collapse;"> <thead> <tr> <th style="text-align:center;">$W (t)$</th> <th style="text-align:center;">2 or less</th> <th style="text-align:center;">3</th> <th style="text-align:center;">4</th> <th style="text-align:center;">5</th> <th style="text-align:center;">6</th> <th style="text-align:center;">7</th> <th style="text-align:center;">8</th> <th style="text-align:center;">9</th> <th style="text-align:center;">10</th> </tr> </thead> <tbody> <tr> <td style="text-align:center;">C_1</td> <td style="text-align:center;">1.35</td> <td style="text-align:center;">1.25</td> <td style="text-align:center;">1.20</td> <td style="text-align:center;">1.17</td> <td style="text-align:center;">1.15</td> <td style="text-align:center;">1.14</td> <td style="text-align:center;">1.13</td> <td style="text-align:center;">1.12</td> <td style="text-align:center;">1.10</td> </tr> <tr> <td style="text-align:center;">C_2</td> <td style="text-align:center;">125</td> <td style="text-align:center;">120</td> <td style="text-align:center;">117</td> <td style="text-align:center;">115</td> <td style="text-align:center;">114</td> <td style="text-align:center;">113</td> <td style="text-align:center;">112</td> <td style="text-align:center;">111</td> <td style="text-align:center;">110</td> </tr> </tbody> </table>		$W (t)$	2 or less	3	4	5	6	7	8	9	10	C_1	1.35	1.25	1.20	1.17	1.15	1.14	1.13	1.12	1.10	C_2	125	120	117	115	114	113	112	111	110	<p>No change</p>
$W (t)$	2 or less	3	4	5	6	7	8	9	10																							
C_1	1.35	1.25	1.20	1.17	1.15	1.14	1.13	1.12	1.10																							
C_2	125	120	117	115	114	113	112	111	110																							
<p>2 The section modulus of stayed posts at the base may be the value specified in reduced by the value obtained from the following formula:</p> $10 \frac{h^3}{d_m} \sum R (cm^3)$ <p>where</p> <p>h : As specified in 3.4.2</p> <p>d_m : Outside diameter of the post at the base in the direction in which R assumes minimum in the slewing range for the formula in -1(1), or in the axis parallel to the athwartship direction of the ship for the formula in -1(2) (cm)</p> <p>$\sum R$: Sum of the values obtained from the following formula for each effective stay:</p> $\frac{d_s^2 a^2}{l_0 l_s^2}$ <p>where</p> <p>d_s : Diameter of the rope for stays (mm)</p> <p>l_s : Length of stays between the upper and lower ends (m)</p> <p>l_0 : Length equal to l_s reduced by the value obtained from the following formula: 0.045d_s+0.26 (m)</p> <p>a : Length of horizontal projection of the stays measured in the same direction as the measurement of d_m (m)</p>	<p>2 The section modulus of stayed posts at the base may be the value specified in reduced by the value obtained from the following formula:</p> $10 \frac{h^3}{d_m} \sum R (cm^3)$ <p>where</p> <p>h : As specified in 3.4.2</p> <p>d_m : Outside diameter of the post at the base in the direction in which R assumes minimum in the slewing range for the formula in -1(1), or in the axis parallel to the athwartship direction of the ship for the formula in -1(2) (cm)</p> <p>$\sum R$: Sum of the values obtained from the following formula for each effective stay:</p> $\frac{d_s^2 a^2}{l_0 l_s^2}$ <p>where</p> <p>d_s : Diameter of the <u>wire</u> rope for stays (mm)</p> <p>l_s : Length of stays between the upper and lower ends (m)</p> <p>l_0 : Length equal to l_s reduced by the value obtained from the following formula: 0.045d_s+0.26 (m)</p> <p>a : Length of horizontal projection of the stays measured in the same direction as the measurement of d_m (m)</p>																															

Amended-Original Requirements Comparison Table (Lifting Appliances and Anchor Handling Winches)

Amended	Original	Remarks
<p>3 Where the derrick booms are supported by a king post with a portal having uniform cross section, the section modulus of the post at the base is not to be less than the values obtained from (1), (2) and (3) below:</p> <p>(1) The section modulus about the axis parallel to the athwartship direction of the ship is to be the value obtained by the formula in -1(1) multiplied by the following coefficient C_p :</p> $0.7 \quad \text{for } r \geq 0.6$ $1 - 0.5r \quad \text{for } r < 0.6$ <p>where r : Ratio of the breadth of the cross section of the portal to the diameter of the post at the base in the longitudinal of the ship</p> <p>(2) The section modulus about the axis parallel to the longitudinal direction of the ship is to be the values obtained from -1(1) or (2), whichever is the greater, multiplied by the following coefficient:</p> $0.35 \quad \text{for } r' \geq 0.3$ $0.5 - 1.67r'^2 \quad \text{for } r' < 0.3$ <p>where r' : Ratio of the depth of the cross section of the portal to the diameter of the post at the base in the athwarship direction</p> <p>(3) Where the distance between posts on the port and starboard sides exceed 2/3 of the height of the post, the coefficients specified in (1) and (2) are to be suitably increased.</p> <p>(Same)</p>	<p>3 Where the derrick booms are supported by a king post with a portal having uniform cross section, the section modulus of the post at the base is not to be less than the values obtained from (1), (2) and (3) below:</p> <p>(1) The section modulus about the axis parallel to the athwartship direction of the ship is to be the value obtained by the formula in -1(1) multiplied by the following coefficient C_p :</p> $0.7 \quad \text{for } r \geq 0.6$ $1 - 0.5r \quad \text{for } r < 0.6$ <p>where r : Ratio of the breadth of the cross section of the portal to the diameter of the post at the base in the longitudinal of the ship</p> <p>(2) The section modulus about the axis parallel to the longitudinal direction of the ship is to be the values obtained from -1(1) or (2), whichever is the greater, multiplied by the following coefficient:</p> $0.35 \quad \text{for } r' \geq 0.3$ $0.5 - 1.67r'^2 \quad \text{for } r' < 0.3$ <p>where r' : Ratio of the depth of the cross section of the portal to the diameter of the post at the base in the athwarship direction</p> <p>(3) Where the distance between posts on the port and starboard sides exceed 2/3 of the height of the post, the coefficients specified in (1) and (2) are to be suitably increased.</p> <p><u>where</u></p> <p>4 The section modulus of the stayed king post at the base is not to be less than the values obtained from (1) and (2) below:</p>	

Amended-Original Requirements Comparison Table (Lifting Appliances and Anchor Handling Winches)

Amended	Original	Remarks
<p>(Same)</p>	<p>(1) The section modulus about the axis parallel to the athwartship direction of the ship is to be the value obtained from the following formula:</p> $C_p \left(C_1 C_2 \rho W - 10 \frac{h^3}{d_m} \sum R \right) (cm^3)$ <p>where C_p : As specified in -3(1) C_1, C_2 and ρ : As specified in -1(1) $10 \frac{h^3}{d_m} \sum R$: Values obtained according to -2, provided that stays on one side only are to be taken into account</p> <p>(2) The section modulus about the axis parallel to the longitudinal direction of the ship is to be the value given in -3(2) above.</p> <p>5 The section modulus of the short side post at the base supporting the derrick boom is not to be less than the value obtained according to (1) or (2) below:</p> <p>(1) When a derrick boom is fitted on either of the forward or aftward side post, the section modulus is to be the value obtained from the following formula:</p> $85 \frac{h'}{h-h'} \rho W (cm^3)$ <p>where W and ρ :As specified in -1(1) h' : As specified in -1(3) h : As specified in 3.4.2</p> <p>(2) Where derrick booms are fitted on the forward and aftward the side post, the section modulus of the side post about the parallel to the longitudinal direction of the ship is to be the greater of the value obtained from (1) or the value obtained from the formula in (1) using, in place of ρW, the product of the sum of W values for</p>	

Amended-Original Requirements Comparison Table (Lifting Appliances and Anchor Handling Winches)

Amended	Original	Remarks
<p>3.4.4 Dimensions of Post other than at the Base (Same)</p> <p>(Same)</p> <p>3.4.5 Outriggers (Same)</p> <p>3.4.6 Portals (Same)</p>	<p>the forward and aftward booms and the value u given in -1(2), provided that u is to be measured from the center of the side post.</p> <p>3.4.4 Dimensions of Post other than at the Base</p> <p>1 The post from well below the base to well above the goose neck bracket is to be of the dimensions equivalent to that at the base as far as practicable.</p> <p>2 The diameter and thickness of the post above the position specified in -1 may be gradually reduced according to the following (1) and (2).</p> <p>(1) The outside diameter where the outrigger or the topping bracket are fitted may be 85% of the diameter at the base.</p> <p>(2) The plate thickness at any arbitrary position of the post is not to be less than obtained from the following formula. $0.1d_m + 2.5 (mm)$ where d_m : Minimum outside diameter of the post at each position (cm)</p> <p>3.4.5 Outriggers Outriggers are to be properly constructed and of sufficient strength.</p> <p>3.4.6 Portals</p> <p>1 The section modulus of the portal of uniform section fitted to the king post is not to be less than the values obtained from (1) to (3) below:</p> <p>(1) The section modulus about the vertical axis is to the value obtained from the formula given in 3.4.3-1(1) multiplied by the coefficient obtained from the</p>	

Amended-Original Requirements Comparison Table (Lifting Appliances and Anchor Handling Winches)

Amended	Original	Remarks
(Same)	<p>following formula. Where this coefficient exceeds 0.2, it may be taken as 0.2.</p> $0.1 + 0.235 \frac{r}{c}$ <p>where</p> <p><i>r</i> : As specified in 3.4.3-3(1)</p> <p><i>c</i> : Ratio of the actual section modulus (<i>cm</i>³) of the post at the base about the axis parallel to the athwarship direction of the ship to that obtained from the formula in 3.4.3-1(1)</p> <p>(2) Notwithstanding the requirements in (1), the section modulus of the portal about the vertical axis may be reduced to a half of the value in (1) where a derrick boom is fitted on either of forward or aftward side of the post.</p> <p>(3) The section modulus about the horizontal axis is to be the value obtained from the formula in 3.4.3-1(2) multiplied by the coefficient obtained from the following formula. Where this coefficient exceeds 0.2, it may be taken as 0.2.</p> $0.25 \frac{r'}{c'}$ <p>where</p> <p><i>r'</i> : As specified in 3.4.3-3(2)</p> <p><i>c'</i> : Ration of the actual section modulus (<i>cm</i>³) of the post at the base about the axis parallel to the longitudinal direction of the ship to that obtained from the formula in 3.4.3-1(2)</p> <p>2 The portal is to be properly stiffened so as to prevent deformation due to bending.</p>	

Amended-Original Requirements Comparison Table (Lifting Appliances and Anchor Handling Winches)

Amended	Original	Remarks
<p>3.4.7 Stays</p> <p>The tension in ropes used for stays is to be less than the value obtained from the following formula.</p> $18 \frac{d_s^2 a}{l_0 l_s} \delta \text{ (kN)}$ <p>where</p> <p>a, d_s, l_0 and l_s : As specified in 3.4.3-2. In this case, a is to be measured in the same direction as in the calculation of the value of δ.</p> <p>δ : Value obtained from the following formula:</p> $C_s \frac{h}{h - h'} \cdot \frac{\rho W}{\frac{I}{h^2} + 7.32h \sum R}$ <p>where</p> <p>I : Moment of inertia of section (cm^4) of the post at the base about the axis parallel to the athwarship direction of the ship. For the king posts, however, the value of I divided by the coefficient C_p given in 3.4.3-3(1) is to be used in place of I.</p> <p>h : As specified in 3.4.2</p> <p>h', W and ρ : As specified in 3.4.3-1(1) and (3)</p> <p>$\sum R$: As specified in 3.4.3-2, In this case, a is to be measured in all directions in the slewing range of the derrick boom in calculating $\sum R$.</p> <p>C_s : Value given in Table 3.5. For intermediate values of W, the coefficient C_s is to be obtained by interpolation.</p>	<p>3.4.7 Stays</p> <p>The tension in <u>wire</u> ropes used for stays is to be less than the value obtained from the following formula.</p> $18 \frac{d_s^2 a}{l_0 l_s} \delta \text{ (kN)}$ <p>where</p> <p>a, d_s, l_0 and l_s : As specified in 3.4.3-2. In this case, a is to be measured in the same direction as in the calculation of the value of δ.</p> <p>δ : Value obtained from the following formula:</p> $C_s \frac{h}{h - h'} \cdot \frac{\rho W}{\frac{I}{h^2} + 7.32h \sum R}$ <p>where</p> <p>I : Moment of inertia of section (cm^4) of the post at the base about the axis parallel to the athwarship direction of the ship. For the king posts, however, the value of I divided by the coefficient C_p given in 3.4.3-3(1) is to be used in place of I.</p> <p>h : As specified in 3.4.2</p> <p>h', W and ρ : As specified in 3.4.3-1(1) and (3)</p> <p>$\sum R$: As specified in 3.4.3-2, In this case, a is to be measured in all directions in the slewing range of the derrick boom in calculating $\sum R$.</p> <p>C_s : Value given in Table 3.5. For intermediate values of W, the coefficient C_s is to be obtained by interpolation.</p>	

Amended-Original Requirements Comparison Table (Lifting Appliances and Anchor Handling Winches)

Amended	Original	Remarks																						
<table border="1" style="margin: auto; border-collapse: collapse;"> <caption>Table 3.5 Values of C_s</caption> <thead> <tr> <th>$W(t)$</th> <th>2 or less</th> <th>3</th> <th>4</th> <th>5</th> <th>6</th> <th>7</th> <th>8</th> <th>9</th> <th>10</th> <th>15 and above</th> </tr> </thead> <tbody> <tr> <td>C_s</td> <td>2.64</td> <td>2.52</td> <td>2.46</td> <td>2.41</td> <td>2.38</td> <td>2.35</td> <td>2.33</td> <td>2.31</td> <td>2.29</td> <td>2.22</td> </tr> </tbody> </table>		$W(t)$	2 or less	3	4	5	6	7	8	9	10	15 and above	C_s	2.64	2.52	2.46	2.41	2.38	2.35	2.33	2.31	2.29	2.22	No change
$W(t)$	2 or less	3	4	5	6	7	8	9	10	15 and above														
C_s	2.64	2.52	2.46	2.41	2.38	2.35	2.33	2.31	2.29	2.22														
<p>3.5 Simplified Calculation Methods for Derrick Booms</p> <p>3.5.1 General (Same)</p> <p>3.5.2 Derrick Booms without Whipped Rigging (Same)</p>	<p>3.5 Simplified Calculation Methods for Derrick Booms</p> <p>3.5.1 General Notwithstanding the requirements in 3.3.1, 3.3.2, 3.3.5, 3.3.6 and 3.3.7, the dimensions of derrick booms may be determined in accordance with requirements in this 3.5.</p> <p>3.5.2 Derrick Booms without Whipped Rigging</p> <p>1 The dimensions of derrick booms of derrick system without whipped rigging are not to be less than obtained according to (1), (2) and (3) below:</p> <p>(1) The moment of inertia of derrick boom at the middle post is not to be less than obtained from the following formula: $C_B P l^2 (cm^4)$ where C_B : Value obtained from Table 3.6 l : Effective length of derrick boom (m) (See Fig. 3.2) P : Axial compression of derrick boom to be determined according to (a) or (b) depending on the type of the derrick systems. When the self-weight of derrick boom and its fitting are accurately estimated, the value obtained from the force diagram may be used as P.</p> <p>(a) Swinging Derrick Systems $P = \left(\alpha_1 \frac{l}{h-h'} + f \right) Wg (kN)$</p>																							

Amended-Original Requirements Comparison Table (Lifting Appliances and Anchor Handling Winches)

Amended	Original	Remarks										
<p>Table 3.6 Values of C_B</p> <table border="1" style="margin-left: auto; margin-right: auto; border-collapse: collapse;"> <thead> <tr> <th style="text-align: center;">Safe working load W (t)</th> <th style="text-align: center;">C_B</th> </tr> </thead> <tbody> <tr> <td style="text-align: center;">$W \leq 10$</td> <td style="text-align: center;">0.28</td> </tr> <tr> <td style="text-align: center;">$10 < W < 15$</td> <td style="text-align: center;">$0.40 - 0.012W$</td> </tr> <tr> <td style="text-align: center;">$15 \leq W \leq 50$</td> <td style="text-align: center;">0.22</td> </tr> <tr> <td style="text-align: center;">$50 < W$</td> <td style="text-align: center;">Value as considered appropriate by the Society</td> </tr> </tbody> </table>	Safe working load W (t)	C_B	$W \leq 10$	0.28	$10 < W < 15$	$0.40 - 0.012W$	$15 \leq W \leq 50$	0.22	$50 < W$	Value as considered appropriate by the Society	<p>where</p> <p>W and h' : As specified in 3.4.3-1(1) and (3)</p> <p>h: As specified in 3.4.2</p> <p>α_1 : Value obtained from Table 3.7. For intermediate values of W, α_1 is to be obtained by interpolation.</p> <p>f: Coefficient obtained from Table 3.8 depending on the number of cargo block for cargo fall. Where the cargo fall is carried to the top of the post through the sheave fixed to the top of the boom, f may be taken as zero.</p> <p>(2) In derrick booms with tapered end parts, the parallel part in the midlength is, as a standard, to be of a length equal to 1/3 of the effective length, and the diameter at the ends is not to be less than 60% of the diameter of the parallel midlength part.</p> <p>(3) The thickness of steel plate used for the body of derrick booms is not to be less than the value obtained from the following formula or 2% of the outside diameter at the middle part whichever is the greater.</p> <p style="margin-left: 40px;">6 (mm) for $P < 75.5$ (kN)</p> <p style="margin-left: 40px;">$5 + 0.0133 P$ (mm) for $P \geq 75.5$ (kN)</p>	<p>No change</p>
Safe working load W (t)	C_B											
$W \leq 10$	0.28											
$10 < W < 15$	$0.40 - 0.012W$											
$15 \leq W \leq 50$	0.22											
$50 < W$	Value as considered appropriate by the Society											

Amended-Original Requirements Comparison Table (Lifting Appliances and Anchor Handling Winches)

Amended	Original	Remarks																																								
<p>Table 3.7 Values of α_1</p> <table border="1" style="width: 100%; border-collapse: collapse; margin-bottom: 20px;"> <thead> <tr> <th style="width: 5%;">$W(t)$</th> <th style="width: 10%;">2 or less</th> <th style="width: 10%;">3</th> <th style="width: 10%;">4</th> <th style="width: 10%;">5</th> <th style="width: 10%;">6</th> <th style="width: 10%;">7</th> <th style="width: 10%;">8</th> <th style="width: 10%;">9</th> <th style="width: 10%;">10</th> <th style="width: 15%;">10 and above</th> </tr> </thead> <tbody> <tr> <td>α_1</td> <td>1.28</td> <td>1.23</td> <td>1.20</td> <td>1.18</td> <td>1.16</td> <td>1.15</td> <td>1.14</td> <td>1.13</td> <td>1.13</td> <td>Value as considered appropriate by the Society</td> </tr> </tbody> </table> <p style="text-align: center;">Table 3.8 Values of f</p> <table border="1" style="width: 100%; border-collapse: collapse; margin-bottom: 20px;"> <thead> <tr> <th style="width: 10%;">n</th> <th style="width: 10%;">1</th> <th style="width: 10%;">2</th> <th style="width: 10%;">3</th> <th style="width: 10%;">4</th> <th style="width: 10%;">5</th> <th style="width: 10%;">6</th> <th style="width: 10%;">7</th> <th style="width: 10%;">8</th> </tr> </thead> <tbody> <tr> <td>f</td> <td>1.102</td> <td>0.570</td> <td>0.392</td> <td>0.304</td> <td>0.251</td> <td>0.216</td> <td>0.192</td> <td>0.172</td> </tr> </tbody> </table> <p>Note: n : The sum of sheaves of cargo block for cargo fall. (b) — Derrick systems other than swinging derrick systems $P = \left(\alpha_1 \frac{l}{h-h_t} + f \right) Wg + \frac{K n_1 \alpha_1 \alpha_2}{n_2 \sqrt{b^2 + l^2}} l Wg \quad (kN)$ where α_1, l, h, h_t, f and W : As specified in (a) α_2 : As specified 5.2.2 b : Horizontal distance from the goose neck bracket to guy post (m) n_1 : Number of guy ropes n_2 : Number of topping ropes K : Values given in Table 3.9 depending on the type of rigging</p>		$W(t)$	2 or less	3	4	5	6	7	8	9	10	10 and above	α_1	1.28	1.23	1.20	1.18	1.16	1.15	1.14	1.13	1.13	Value as considered appropriate by the Society	n	1	2	3	4	5	6	7	8	f	1.102	0.570	0.392	0.304	0.251	0.216	0.192	0.172	No change
$W(t)$	2 or less	3	4	5	6	7	8	9	10	10 and above																																
α_1	1.28	1.23	1.20	1.18	1.16	1.15	1.14	1.13	1.13	Value as considered appropriate by the Society																																
n	1	2	3	4	5	6	7	8																																		
f	1.102	0.570	0.392	0.304	0.251	0.216	0.192	0.172																																		

Amended-Original Requirements Comparison Table (Lifting Appliances and Anchor Handling Winches)

Amended	Original	Remarks								
<p>Table 3.9 Values of K</p> <table border="1" style="margin: auto; border-collapse: collapse;"> <thead> <tr> <th style="text-align: center;">Rigging system</th> <th style="text-align: center;">K</th> </tr> </thead> <tbody> <tr> <td style="text-align: center;">Type <i>A</i></td> <td style="text-align: center;">0</td> </tr> <tr> <td style="text-align: center;">Type <i>B</i></td> <td style="text-align: center;">1.2</td> </tr> <tr> <td style="text-align: center;">Type <i>C</i></td> <td style="text-align: center;">2.0</td> </tr> </tbody> </table> <p>Notes:</p> <ol style="list-style-type: none"> 1. Type <i>A</i> is rigging system having two guy tackles on port and starboard sides of the top of the post so that these guy tackles may also serve as topping lifts. 2. Type <i>B</i> is a rigging system having a deltaplate connecting the end of topping lift and ends of port and starboard side guy ropes so that the tension of topping lift may absorb the slackening of guy ropes. 3. Type <i>C</i> is a rigging systems having a connecting block connecting the end of guy rope(s) of both sides (or of one side) and the topping lift led along the derrick post so that the slackening of guy rope(s) may be absorbed by the topping lift. 		Rigging system	K	Type <i>A</i>	0	Type <i>B</i>	1.2	Type <i>C</i>	2.0	No change
Rigging system	K									
Type <i>A</i>	0									
Type <i>B</i>	1.2									
Type <i>C</i>	2.0									
<p>(Same)</p> <p>3.5.3 Derrick Booms with Whipped Rigging (Same)</p>	<p>2 The shape and dimensions of the derrick boom of swinging derrick system may be in accordance with <i>JIS F 2201</i> or any other standards recognized by the Society to be equivalent.</p> <p>3.5.3 Derrick Booms with Whipped Rigging The dimensions of derrick booms of derrick system with whipped rigging are not to be less than obtained according to (1) and (2).</p> <p>(1) The moment of inertia of section at an arbitrary position at a distance of x (m) from the center of eye fitting at derrick heel is not to be less than obtained from the following formula. Where a doubling plate is fitted for a sufficient length, 70% of the doubling plate may be added to $D(x)$ and $A(x)$ in the formula.</p>									

Amended-Original Requirements Comparison Table (Lifting Appliances and Anchor Handling Winches)

Amended	Original	Remarks
	$I(x) = C_B P l^2 \left\{ 1 - 3.136 \left(\frac{x}{l} - 0.5 \right)^2 \right\} + \frac{D(x) l_1 x}{2 \left(\sigma_0 - \frac{P}{A(x)} \times 10 \right) l} \cdot \frac{W g}{N} \cos \theta \times 10^3$ <p>where</p> <p>$I(x)$: Required moment of inertia of section at a distance of x (m) from the derrick heel (cm^4)</p> <p>C_B : As specified in 3.5.2</p> <p>P : Axial compression of boom specified in 3.5.2-1(1) (kN)</p> <p>l : Effective length of boom (m)</p> <p>W : Safe working load as specified in 3.4.3-1(1) (t)</p> <p>N : Sum of sheaves of cargo block for cargo fall (except cargo block for cargo relief)</p> <p>θ : Allowable minimum angle of boom (degree)</p> <p>l_1 : Distance between the eye fittings for whipped rigging (m)(See Fig. 3.2)</p> <p>$D(x)$: Outside diameter of derrick boom at a distance of x (m) from the boom heel minus plate thickness (cm)</p> <p>$A(x)$: Sectional area of derrick boom at a distance of x (m) from the boom heel (cm^2)</p> <p>σ_0 : Value given in Table 3.10 (N/mm^2)</p> <p>(2) The length of parallel part at the middle, the diameter at ends and the plate thickness of the boom body are to be as specified in 3.5.2-1(2) and (3).</p>	

Amended-Original Requirements Comparison Table (Lifting Appliances and Anchor Handling Winches)

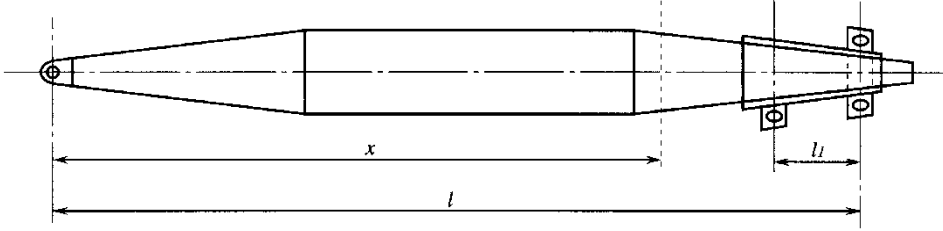
Amended	Original	Remarks										
<p>Fig. 3.2 Derrick Boom with Whipped Rigging</p> 		No change										
<p>Table 3.10 Values of σ_0</p> <table border="1" style="margin: auto; border-collapse: collapse;"> <thead> <tr> <th style="text-align: center;">Safe working load W (t)</th> <th style="text-align: center;">σ_0</th> </tr> </thead> <tbody> <tr> <td style="text-align: center;">$W \leq 10$</td> <td style="text-align: center;">80.4</td> </tr> <tr> <td style="text-align: center;">$10 < W < 15$</td> <td style="text-align: center;">$4.04W + 40.0$</td> </tr> <tr> <td style="text-align: center;">$15 \leq W \leq 50$</td> <td style="text-align: center;">100.6</td> </tr> <tr> <td style="text-align: center;">$50 < W$</td> <td style="text-align: center;">Value as considered appropriate by the Society</td> </tr> </tbody> </table>		Safe working load W (t)	σ_0	$W \leq 10$	80.4	$10 < W < 15$	$4.04W + 40.0$	$15 \leq W \leq 50$	100.6	$50 < W$	Value as considered appropriate by the Society	No change
Safe working load W (t)	σ_0											
$W \leq 10$	80.4											
$10 < W < 15$	$4.04W + 40.0$											
$15 \leq W \leq 50$	100.6											
$50 < W$	Value as considered appropriate by the Society											
<p>Chapter 4</p> <p>CRANES</p> <p>4.1 General</p> <p>4.1.1 Application (Same)</p>	<p>Chapter 4</p> <p>CRANES</p> <p>4.1 General</p> <p>4.1.1 Application The requirements in this Chapter apply to the structural members of cranes.</p>											

Amended-Original Requirements Comparison Table (Lifting Appliances and Anchor Handling Winches)

Amended	Original	Remarks
<p>4.2 Design Loads</p> <p>4.2.1 Load Considerations The loads to be taken into the calculation of dimensions of structural members are to be those related to the crane concerned among the items enumerated from (1) to (11) below:</p> <ol style="list-style-type: none"> (1) Safe working load of the cranes (2) <u>Additional impact loads (loads calculated based on the values of the impact load coefficients in Table 4.1 minus 1)</u> (3) Self-weight of crane system and cargo fittings attached thereto (4) Self-weight of loose gear (5) Friction of cargo blocks (6) Horizontal forces (7) Wind loading (8) Buffer forces (9) Loads due to ship inclination (10) Loads due to ship motion (11) Other loads considered necessary by the Society <p>4.2.2 Impact Loads* (Same)</p>	<p>4.2 Design Loads</p> <p>4.2.1 Load Considerations The loads to be taken into the calculation of dimensions of structural members are to be those related to the crane concerned among the items enumerated from (1) to (11) below:</p> <ol style="list-style-type: none"> (1) Safe working load of the cranes (2) Impact loads (3) Self-weight of crane system and cargo fittings attached thereto (4) Self-weight of loose gear (5) Friction of cargo blocks (6) Horizontal forces (7) Wind loading (8) Buffer forces (9) Loads due to ship inclination (10) Loads due to ship motion (11) Other loads considered necessary by the Society <p>4.2.2 Impact Loads 1 The impact load is to be the product of the hoisting load and the impact load coefficient given in Table 4.1 depending on the types of cranes or the impact load coefficient deemed appropriate by the Society. When the stress due to hoisting of cargo and the stress due to the self weight have different signs in a member, 50% of impact load is to be taken into account in addition to the self-weight, considering the shock due to unloading.</p>	<p>Amends impact load to additional impact load to eliminate the duplication of the self-weight of lifting appliance because impact load includes the self-weight of lifting appliances.</p>

Amended-Original Requirements Comparison Table (Lifting Appliances and Anchor Handling Winches)

Amended	Original	Remarks										
(Same)	<p>2 Notwithstanding the requirements specified in -1, impact load coefficient based on actual measurements taking into account the hoisting speed, deflections of girders, length of ropes, etc. may be used in place of the values given in Table 4.1.</p> <p align="center">Table 4.1 Impact Load Coefficient</p> <table border="1"> <thead> <tr> <th align="center">Types of cranes</th> <th align="center">Impact load coefficient</th> </tr> </thead> <tbody> <tr> <td>Provision handling crane, Machinery handling crane, Maintenance crane and Hose handling crane</td> <td align="center">1.10</td> </tr> <tr> <td>Jib crane and gantry crane for cargo handling</td> <td align="center">1.25</td> </tr> <tr> <td>Jib crane and gantry crane occasionally used with hydraulically operated of rope-operated bucket, etc. for cargo handling</td> <td align="center">1.40</td> </tr> <tr> <td>Jib crane and gantry crane always using grab, lifting magnet, etc. for cargo handling and Offshore jib crane</td> <td align="center">1.60</td> </tr> </tbody> </table>	Types of cranes	Impact load coefficient	Provision handling crane, Machinery handling crane, Maintenance crane and Hose handling crane	1.10	Jib crane and gantry crane for cargo handling	1.25	Jib crane and gantry crane occasionally used with hydraulically operated of rope-operated bucket, etc. for cargo handling	1.40	Jib crane and gantry crane always using grab, lifting magnet, etc. for cargo handling and Offshore jib crane	1.60	No change
Types of cranes	Impact load coefficient											
Provision handling crane, Machinery handling crane, Maintenance crane and Hose handling crane	1.10											
Jib crane and gantry crane for cargo handling	1.25											
Jib crane and gantry crane occasionally used with hydraulically operated of rope-operated bucket, etc. for cargo handling	1.40											
Jib crane and gantry crane always using grab, lifting magnet, etc. for cargo handling and Offshore jib crane	1.60											
<p>4.2.3 Friction of Cargo Blocks (同右)</p> <p>4.2.4 Horizontal Forces (Same)</p> <p>(Same)</p>	<p>4.2.3 Friction of Cargo Blocks The friction of cargo blocks is to be as specified in 3.2.2</p> <p>4.2.4 Horizontal Forces 1 In track-mounted cranes, the transverse forces due to travel motion is to be taken into consideration as a factor of horizontal force in addition to the inertial force and centrifugal force. 2 The inertial force is to be obtained by multiplying the sum of the mass of the moving parts and the hoisting load (in slewing motion, the load is assumed to be at the top of jib) by the following coefficient depending on the condition of motion. In the case of travelling by driven wheels, however, this inertial force need not exceed 15% of the driving wheel load.</p>											

Amended-Original Requirements Comparison Table (Lifting Appliances and Anchor Handling Winches)

Amended	Original	Remarks
<p>3 Notwithstanding the requirements in -2, the values of the actual acceleration deceleration characteristics, the actual braking time, etc. for the mode of motion concerned may be used as the inertial forces, if such values are known. (Same)</p> <p>(Same)</p>	<p>Level luffing motions: $0.01\sqrt{V}$ Traversing or travelling motions: $0.008\sqrt{V}$ Slewing motions: $0.006\sqrt{V}$</p> <p>where V : Velocity of motion concerned to be determined by the designer (m/min)</p> <p>3 Notwithstanding the requirements in -2 the values of the actual acceleration deceleration characteristics, the actual braking time, etc. for the mode of motion concerned may be used as the inertial forces, if such values are known.</p> <p>4 The centrifugal force is to be considered for slewing motions and is to be determined from following formula.</p> $\frac{Wv^2}{R} (kN)$ <p>where W : Safe working load (t) R : Slewing radius (m) v : Circular speed (m/sec)</p> <p>5 The transverse force due to travel motions is to be calculated from the following formula: $\lambda D (kN)$</p> <p>where D : Wheel load (kN) λ : Transverse force coefficient to be determined from the following formula depending on the value of l/a. However, λ need not exceed 0.15:</p> $0.05 \quad \text{for } \frac{l}{a} \leq 2$ $\frac{1}{60} \left(\frac{l}{a} + 1 \right) \quad \text{for } \frac{l}{a} > 2$ <p>l : Span of rails (m) a : Effective wheel base to be</p>	

Amended-Original Requirements Comparison Table (Lifting Appliances and Anchor Handling Winches)

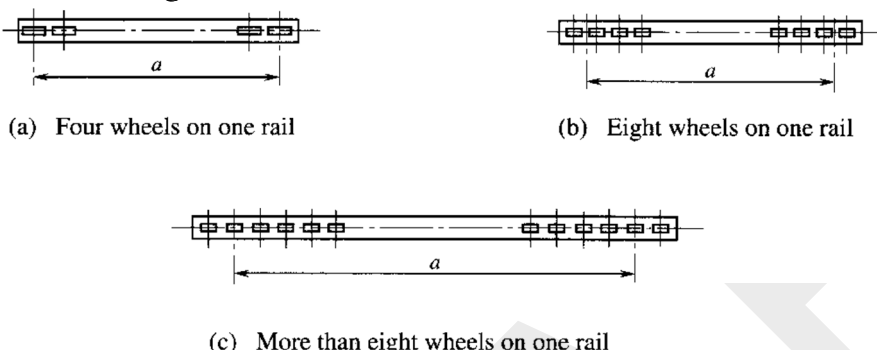
Amended	Original	Remarks
<p align="center">4.2.5 Wind Loading</p> <p>1 The wind loading is to be calculated by the following formula:</p> $F=PA\times 10^{-3} \text{ (kN)}$ <p>where</p> <p><i>F</i> : Wind loading (kN)</p> <p><i>A</i> : Sum of structural members and cargo under wind pressure in projection in respective wind direction, corresponding to respective conditions of the <u>lifting appliance</u> (m^2). When a girder is wholly or partly protected from wind by another girder, the areas of the superposed portions may be multiplied by the reduction factor (η) obtained from Fig. 4.2. The distance <i>b</i> between girders is to be as given in Fig. 4.3.</p> <p><i>P</i> : Wind pressure calculated by the following formula (Pa).</p>	<p align="center">determined according to Fig. 4.1 (m)</p> <p align="center">Fig. 4.1 Measurement of Effective Wheel Base</p>  <p align="center">(a) Four wheels on one rail</p> <p align="center">(b) Eight wheels on one rail</p> <p align="center">(c) More than eight wheels on one rail</p> <p align="center">4.2.5 Wind Loading</p> <p>1 The wind loading is to be calculated by the following formula:</p> $F=PA\times 10^{-3} \text{ (kN)}$ <p>where</p> <p><i>F</i> : Wind loading (kN)</p> <p><i>A</i> : Sum of structural members and cargo under wind pressure in projection in respective wind direction, corresponding to respective conditions of the <u>cargo gear</u> (m^2). When a girder is wholly or partly protected from wind by another girder, the areas of the superposed portions may be multiplied by the reduction factor (η) obtained from Fig. 4.2. The distance <i>b</i> between girders is to be as given in Fig. 4.3.</p> <p><i>P</i> : Wind pressure calculated by the following formula (Pa).</p>	<p align="center">No change</p>

Amended-Original Requirements Comparison Table (Lifting Appliances and Anchor Handling Winches)

Amended	Original	Remarks
$\frac{1}{16} C_h C_s g V^2 \text{ (Pa)}$ <p>where <i>V</i> : Wind velocity according to (1) and (2) below (m/sec):</p> <p>(1) The velocity of wind giving effect on the structural members and cargo in the service conditions is to be the design wind velocity specified by the applicant, but not be less than 16 <i>m/sec</i>.</p> <p>(2) The velocity of wind giving effect on the structural members in the stowage conditions is to be the design wind velocity specified by the applicant. In no case is the design wind velocity to be less than 55 <i>m/sec</i>. In ships with restricted navigation areas, however, the design wind velocity may be decreased according to the degree of restriction as approved by the Society in the range down to 27.5 <i>m/sec</i>.</p> <p><i>C_h</i> : “Height factor” to be determined according to Table 4.2 depending on the height of the position is question from the lightweight waterline.</p> <p><i>C_s</i> : “Shape factor” to be determined according to Table 4.3 depending on the shapes of various parts of the <u>lifting appliance</u> and the cargo</p> <p>(Same)</p>	$\frac{1}{16} C_h C_s g V^2 \text{ (Pa)}$ <p>where <i>V</i> : Wind velocity according to (1) and (2) below (m/sec):</p> <p>(1) The velocity of wind giving effect on the structural members and cargo in the service conditions is to be the design wind velocity specified by the applicant, but not be less than 16 <i>m/sec</i>.</p> <p>(2) The velocity of wind giving effect on the structural members in the stowage conditions is to be the design wind velocity specified by the applicant. In no case is the design wind velocity to be less than 55 <i>m/sec</i>. In ships with restricted navigation areas, however, the design wind velocity may be decreased according to the degree of restriction as approved by the Society in the range down to 27.5 <i>m/sec</i>.</p> <p><i>C_h</i> : “Height factor” to be determined according to Table 4.2 depending on the height of the position is question from the lightweight waterline.</p> <p><i>C_s</i> : “Shape factor” to be determined according to Table 4.3 depending on the shapes of various parts of the <u>cargo gear</u> and the cargo</p> <p>2 Notwithstanding the requirements in -1, the data on wind loading obtained by wind tunnel tests for the structural members and cargo may be used for calculations.</p>	

Amended-Original Requirements Comparison Table (Lifting Appliances and Anchor Handling Winches)

Amended	Original	Remarks																																																								
<p>Fig. 4.2 Repletiness Ratio, ϕ versus Reduction Factor, η</p> <p style="text-align: center;">$b/h = 6$</p> <table border="1" style="margin: 10px auto; border-collapse: collapse;"> <caption>Approximate data points from Fig. 4.2</caption> <thead> <tr> <th>η</th> <th>ϕ ($b/h=0.5$)</th> <th>ϕ ($b/h=1$)</th> <th>ϕ ($b/h=2$)</th> <th>ϕ ($b/h=3$)</th> <th>ϕ ($b/h=4$)</th> <th>ϕ ($b/h=5$)</th> <th>ϕ ($b/h=6$)</th> </tr> </thead> <tbody> <tr><td>0.0</td><td>1.00</td><td>1.00</td><td>1.00</td><td>1.00</td><td>1.00</td><td>1.00</td><td>1.00</td></tr> <tr><td>0.2</td><td>0.38</td><td>0.65</td><td>0.80</td><td>0.90</td><td>0.95</td><td>0.98</td><td>1.00</td></tr> <tr><td>0.4</td><td>0.20</td><td>0.45</td><td>0.65</td><td>0.80</td><td>0.88</td><td>0.93</td><td>0.97</td></tr> <tr><td>0.6</td><td>0.05</td><td>0.25</td><td>0.45</td><td>0.60</td><td>0.75</td><td>0.82</td><td>0.88</td></tr> <tr><td>0.8</td><td>0.05</td><td>0.18</td><td>0.30</td><td>0.45</td><td>0.60</td><td>0.70</td><td>0.75</td></tr> <tr><td>1.0</td><td>0.05</td><td>0.15</td><td>0.25</td><td>0.35</td><td>0.50</td><td>0.65</td><td>0.70</td></tr> </tbody> </table>			η	ϕ ($b/h=0.5$)	ϕ ($b/h=1$)	ϕ ($b/h=2$)	ϕ ($b/h=3$)	ϕ ($b/h=4$)	ϕ ($b/h=5$)	ϕ ($b/h=6$)	0.0	1.00	1.00	1.00	1.00	1.00	1.00	1.00	0.2	0.38	0.65	0.80	0.90	0.95	0.98	1.00	0.4	0.20	0.45	0.65	0.80	0.88	0.93	0.97	0.6	0.05	0.25	0.45	0.60	0.75	0.82	0.88	0.8	0.05	0.18	0.30	0.45	0.60	0.70	0.75	1.0	0.05	0.15	0.25	0.35	0.50	0.65	0.70
η	ϕ ($b/h=0.5$)	ϕ ($b/h=1$)	ϕ ($b/h=2$)	ϕ ($b/h=3$)	ϕ ($b/h=4$)	ϕ ($b/h=5$)	ϕ ($b/h=6$)																																																			
0.0	1.00	1.00	1.00	1.00	1.00	1.00	1.00																																																			
0.2	0.38	0.65	0.80	0.90	0.95	0.98	1.00																																																			
0.4	0.20	0.45	0.65	0.80	0.88	0.93	0.97																																																			
0.6	0.05	0.25	0.45	0.60	0.75	0.82	0.88																																																			
0.8	0.05	0.18	0.30	0.45	0.60	0.70	0.75																																																			
1.0	0.05	0.15	0.25	0.35	0.50	0.65	0.70																																																			
<p>Fig. 4.3 Distance between two Neighbouring Girders, b</p>																																																										
		No change																																																								

Amended-Original Requirements Comparison Table (Lifting Appliances and Anchor Handling Winches)

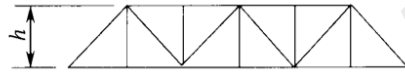
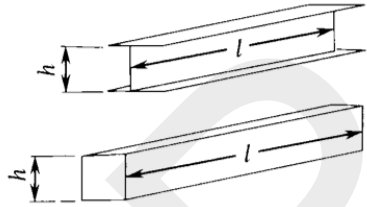
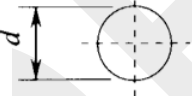
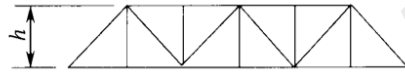
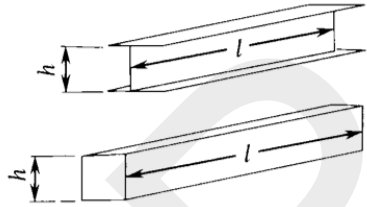
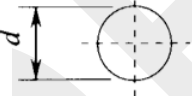
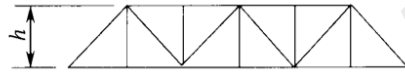
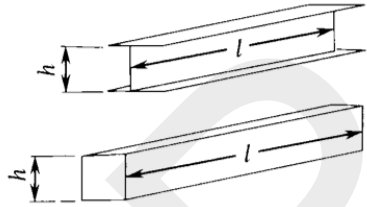
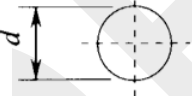
Amended	Original	Remarks														
<p>Table 4.2 Height Factor C_h</p> <table border="1" style="margin: auto; border-collapse: collapse;"> <thead> <tr> <th style="text-align: center;">Vertical height h (m)</th> <th style="text-align: center;">C_h</th> </tr> </thead> <tbody> <tr> <td style="text-align: center;">$h < 15.3$</td> <td style="text-align: center;">1.00</td> </tr> <tr> <td style="text-align: center;">$15.3 \leq h < 30.5$</td> <td style="text-align: center;">1.10</td> </tr> <tr> <td style="text-align: center;">$30.5 \leq h < 46.0$</td> <td style="text-align: center;">1.20</td> </tr> <tr> <td style="text-align: center;">$46.0 \leq h < 61.0$</td> <td style="text-align: center;">1.30</td> </tr> <tr> <td style="text-align: center;">$61.0 \leq h < 76.0$</td> <td style="text-align: center;">1.37</td> </tr> <tr> <td style="text-align: center;">$76.0 \leq h$</td> <td style="text-align: center;">Value as considered appropriate by the Society</td> </tr> </tbody> </table>		Vertical height h (m)	C_h	$h < 15.3$	1.00	$15.3 \leq h < 30.5$	1.10	$30.5 \leq h < 46.0$	1.20	$46.0 \leq h < 61.0$	1.30	$61.0 \leq h < 76.0$	1.37	$76.0 \leq h$	Value as considered appropriate by the Society	No change
Vertical height h (m)	C_h															
$h < 15.3$	1.00															
$15.3 \leq h < 30.5$	1.10															
$30.5 \leq h < 46.0$	1.20															
$46.0 \leq h < 61.0$	1.30															
$61.0 \leq h < 76.0$	1.37															
$76.0 \leq h$	Value as considered appropriate by the Society															
<p>Table 4.3 Shape Factor C_s</p> <table border="1" style="margin: auto; border-collapse: collapse;"> <thead> <tr> <th style="text-align: center;">Type of area under wind pressure</th> <th style="text-align: center;">ϕ or size ratio</th> <th style="text-align: center;">C_s</th> </tr> </thead> <tbody> <tr> <td style="text-align: center;"> Truss of angle  </td> <td style="text-align: center;"> ϕ $\phi < 0.1$ $0.1 \leq \phi < 0.3$ $0.3 \leq \phi < 0.9$ $0.9 \leq \phi$ </td> <td style="text-align: center;"> 2.0 1.8 1.6 2.0 </td> </tr> <tr> <td style="text-align: center;"> Plate girder or Box girder  </td> <td style="text-align: center;"> l/h $\phi < 5$ $5 \leq \phi < 10$ $10 \leq \phi < 15$ $15 \leq \phi < 25$ $25 \leq \phi < 50$ $50 \leq \phi < 100$ $100 \leq \phi$ </td> <td style="text-align: center;"> 1.2 1.3 1.4 1.6 1.7 1.8 1.9 </td> </tr> <tr> <td style="text-align: center;"> Cylinder member or Truss of cylindrical member  </td> <td style="text-align: center;"> $d\sqrt{q}$ $d\sqrt{q} < 1.0$ $1.0 \leq d\sqrt{q}$ </td> <td style="text-align: center;"> 1.2 0.7 </td> </tr> </tbody> </table>		Type of area under wind pressure	ϕ or size ratio	C_s	Truss of angle 	ϕ $\phi < 0.1$ $0.1 \leq \phi < 0.3$ $0.3 \leq \phi < 0.9$ $0.9 \leq \phi$	2.0 1.8 1.6 2.0	Plate girder or Box girder 	l/h $\phi < 5$ $5 \leq \phi < 10$ $10 \leq \phi < 15$ $15 \leq \phi < 25$ $25 \leq \phi < 50$ $50 \leq \phi < 100$ $100 \leq \phi$	1.2 1.3 1.4 1.6 1.7 1.8 1.9	Cylinder member or Truss of cylindrical member 	$d\sqrt{q}$ $d\sqrt{q} < 1.0$ $1.0 \leq d\sqrt{q}$	1.2 0.7	No change		
Type of area under wind pressure	ϕ or size ratio	C_s														
Truss of angle 	ϕ $\phi < 0.1$ $0.1 \leq \phi < 0.3$ $0.3 \leq \phi < 0.9$ $0.9 \leq \phi$	2.0 1.8 1.6 2.0														
Plate girder or Box girder 	l/h $\phi < 5$ $5 \leq \phi < 10$ $10 \leq \phi < 15$ $15 \leq \phi < 25$ $25 \leq \phi < 50$ $50 \leq \phi < 100$ $100 \leq \phi$	1.2 1.3 1.4 1.6 1.7 1.8 1.9														
Cylinder member or Truss of cylindrical member 	$d\sqrt{q}$ $d\sqrt{q} < 1.0$ $1.0 \leq d\sqrt{q}$	1.2 0.7														
<p>Notes:</p> <p>ϕ : Repletteness ratio equal to the ratio of projected area under wind pressure to the projected area surrounded by the outer contour of the area under wind pressure</p> <p>l : Length of plate girder or box girder (m)</p> <p>h : Height of plate girder or box girder looked at from windward (m)</p> <p>d : Outer diameter of cylindrical member (m)</p> <p>q : Value calculated by the following formula:</p> $\frac{1}{16} C_h \cdot gV^2 \times 10^{-3} \text{ (kPa)}$																

Amended-Original Requirements Comparison Table (Lifting Appliances and Anchor Handling Winches)

Amended	Original	Remarks
<p>4.2.6 Buffer Forces (Same)</p> <p>(Same)</p>	<p>4.2.6 Buffer Forces</p> <p>1 The buffer forces are assumed to be the loads in the crane system originating from collision with buffer at a speed equal to 70% of the rated speed when no cargo is suspended from the crane. In a crane system having a rigid guide, etc. to limit the swinging of suspended cargo due to collision, the influence of the cargo weight is also to be taken into consideration.</p> <p>2 Notwithstanding the requirement in -1, in a crane system designed to be automatically decelerated before colliding the buffer, the speed after deceleration may be regarded as the rated speed in the requirement in -1.</p>	
<p>4.2.7 Loads due to Ship Inclination* (Same)</p>	<p>4.2.7 Loads due to Ship Inclination*</p> <p>The angles of inclination used for the calculation of loads due to ship inclination are not to be less than the values specified below:</p> <p style="padding-left: 40px;">In service conditions: 5 degrees in angle of heel and 2 degrees in angle of trim occurring simultaneously</p> <p style="padding-left: 40px;">In stowage conditions: 30 degrees in angle of heel</p>	
<p>4.2.8 Loads due to Ship Motion (Same)</p>	<p>4.2.8 Loads due to Ship Motion</p> <p>The accelerations used for the calculation of loads due to ship motion are the severest of the combinations (1) or (2) below for the stowage condition, and values recognized by the Society to be appropriate for the service condition. If data on the ship's motions are submitted and recognized by the Society to be appropriate, the values in such data may be used in the calculations.</p> <p>(1) $\pm 1.0 g$ in the direction normal to the deck and $\pm 0.5 g$ in the longitudinal direction parallel to the deck</p> <p>(2) $\pm 1.0 g$ in the direction normal to the deck and ± 0.5</p>	

Amended-Original Requirements Comparison Table (Lifting Appliances and Anchor Handling Winches)

Amended	Original	Remarks
<p align="center">4.2.9 Load Combinations* (Same)</p> <p>2 When the wind loading is not taken into account in service condition, the sum of loads from (1) to (9) below multiplied by a work coefficient given in Table 4.4 according to the type of crane concerned or a work coefficient deemed appropriate by the Society is to be considered.</p> <p>(1) Safe working load of the cranes (2) <u>Additional impact loads (loads calculated based on the values of impact load coefficients in Table 4.1 minus 1)</u> (3) Self-weights of crane system and loose gear attached thereto (4) Self-weights of loose gear (5) Friction of cargo blocks (6) Horizontal loads (7) Loads due to ship inclination (8) Loads due to ship motion (except those intended to cargo handling in harbours only) (9) Other loads considered necessary by the Society (Same)</p> <p>(Same)</p>	<p align="center">4.2.9 Load Combinations*</p> <p>1 The load to be used in the strength analysis of structural members is to be such a combined load that these members may be put in the severest loading condition considering the loads specified in -2 through -5 below.</p> <p>2 When the wind loading is not taken into account in service condition, the sum of loads from (1) to (9) below multiplied by a work coefficient given in Table 4.4 according to the type of crane concerned or a work coefficient deemed appropriate by the Society is to be considered.</p> <p>(1) Safe working load of the cranes (2) Impact loads (3) Self-weights of crane system and loose gear attached thereto (4) Self-weights of loose gear (5) Friction of cargo blocks (6) Horizontal loads (7) Loads due to ship inclination (8) Loads due to ship motion (except those intended to cargo handling in harbours only) (9) Other loads considered necessary by the Society</p> <p>3 When the wind loading are to be taken into consideration in the service conditions, the wind loading is to be added to the design load as specified in -2.</p> <p>4 The buffer forces as given in 4.2.6 are to be taken into consideration for the track-mounted cranes.</p>	<p>Amends impact load to additional impact load to eliminate the duplication of the self-weight of lifting appliance because impact load includes the self-weight of lifting appliances.</p>

Amended-Original Requirements Comparison Table (Lifting Appliances and Anchor Handling Winches)

Amended	Original	Remarks									
<p>(Same)</p>	<p>5 In stowage condition, the loads from (1) to (5) below are to be considered</p> <ul style="list-style-type: none"> (1) Self-weights of crane system and loose gear attached thereto (2) Wind loading in the stowage conditions (3) Loads due to ship inclination in the stowage conditions (4) Loads due to ship motion stowage conditions (5) Other loads considered necessary by the Society 	<p>No change</p>									
<p>Table 4.4 Work Coefficient of Crane Systems</p> <table border="1"> <thead> <tr> <th align="center">Type of crane</th> <th align="center">Work coefficient</th> </tr> </thead> <tbody> <tr> <td>Provision handling crane, Machinery handling crane, Maintenance and Hose handling crane</td> <td align="center">1.00</td> </tr> <tr> <td>Jib crane and gantry crane for cargo handling</td> <td align="center">1.05</td> </tr> <tr> <td>Jib crane and gantry crane occasionally used with hydraulically operated or rope-operated bucket, etc. for cargo handling</td> <td align="center">1.10</td> </tr> <tr> <td>Jib crane and gantry crane always using grab, lifting magnet, etc. for cargo and Offshore jib crane</td> <td align="center">1.20</td> </tr> </tbody> </table>			Type of crane	Work coefficient	Provision handling crane, Machinery handling crane, Maintenance and Hose handling crane	1.00	Jib crane and gantry crane for cargo handling	1.05	Jib crane and gantry crane occasionally used with hydraulically operated or rope-operated bucket, etc. for cargo handling	1.10	Jib crane and gantry crane always using grab, lifting magnet, etc. for cargo and Offshore jib crane
Type of crane	Work coefficient										
Provision handling crane, Machinery handling crane, Maintenance and Hose handling crane	1.00										
Jib crane and gantry crane for cargo handling	1.05										
Jib crane and gantry crane occasionally used with hydraulically operated or rope-operated bucket, etc. for cargo handling	1.10										
Jib crane and gantry crane always using grab, lifting magnet, etc. for cargo and Offshore jib crane	1.20										
<p>4.3 Strength and Construction</p> <p>4.3.1 General*</p> <p>(Same)</p> <p>(Same)</p>	<p>4.3 Strength and Construction</p> <p>4.3.1 General*</p> <p>1 The strength of structural members is to be analyzed on the load conditions specified in 4.2.9 to determine their dimensions according to requirements in 4.3.2 through 4.3.10.</p> <p>2 For structures connected by bolts and nuts, proper considerations are to be given to the decrease of effective sectional areas.</p>										

Amended-Original Requirements Comparison Table (Lifting Appliances and Anchor Handling Winches)

Amended	Original	Remarks
(Same)	<p>3 When considered necessary the Society may require the confirmation of the appropriateness of strength analyses by examination of models or the things in question.</p>	
4.3.2 Allowable Stress for Loads	4.3.2 Allowable Stress for Loads	
(Same)	<p>1 The allowable stress given in Table 4.5 is not to be exceeded depending on the type of stress.</p>	
(Same)	<p>2 Strength for fixed posts is to be in accordance with the requirements in 3.3.2.</p>	
4.3.3 Buckling Strength	4.3.3 Buckling Strength	
(Same)	<p>For members subjected to compression, the values obtained from the following formula is not to exceed the allowable compressive stress given in Table 4.5.</p> $\omega \sigma_c \text{ (N/mm}^2\text{)}$ <p>where ω and σ_c : As specified in 3.3.5</p>	
4.3.4 Combined Compressive Stress	4.3.4 Combined Compressive Stress	
(Same)	<p>When the compressive stress of a member is determined as a combination of compressive stress due to axial compression and that due to bending moment such a compressive stress is to comply with the following formula:</p> $\frac{\sigma_c}{\sigma_{ca}} + \frac{\sigma_b}{\sigma_a} \leq 1.0$ <p>where σ_b : Compressive stress due to bending moment (N/mm²) σ_c : Compressive stress due to axial compression (N/mm²) σ_a : Allowable bending stress given in Table 4.5 (N/mm²). For fixed posts at the base, however, the allowable stress σ_a in Table 3.1 is to be used.</p>	

Amended-Original Requirements Comparison Table (Lifting Appliances and Anchor Handling Winches)

Amended	Original	Remarks																																									
<p style="text-align: center;">Table 4.5 Allowable Stress σ_a</p> <table border="1" style="width: 100%; border-collapse: collapse; margin-bottom: 10px;"> <thead> <tr> <th rowspan="3" style="width: 30%;">Load Condition</th> <th colspan="7">Kind of stress</th> </tr> <tr> <th rowspan="2" style="width: 10%;">Tension</th> <th colspan="2">Bending</th> <th rowspan="2" style="width: 10%;">Shear</th> <th rowspan="2" style="width: 10%;">Compression</th> <th rowspan="2" style="width: 10%;">Bearing</th> <th rowspan="2" style="width: 10%;">Combined stress</th> </tr> <tr> <th style="width: 10%;">Tension side</th> <th style="width: 10%;">Compression side</th> </tr> </thead> <tbody> <tr> <td>Condition specified in 4.2.9-2</td> <td>σ_d</td> <td>σ_d</td> <td>$0.87\sigma_d$</td> <td>$0.58\sigma_d$</td> <td>$0.87\sigma_d$</td> <td>$1.41\sigma_d$</td> <td>$1.15\sigma_d$</td> </tr> <tr> <td>Condition specified in 4.2.9-3</td> <td>$1.15\sigma_d$</td> <td>$1.15\sigma_d$</td> <td>σ_d</td> <td>$0.67\sigma_d$</td> <td>σ_d</td> <td>$1.63\sigma_d$</td> <td>$1.33\sigma_d$</td> </tr> <tr> <td>Condition specified in 4.2.9-4 and -5</td> <td>$1.3\sigma_d$</td> <td>$1.3\sigma_d$</td> <td>$1.13\sigma_d$</td> <td>$0.75\sigma_d$</td> <td>$1.14\sigma_d$</td> <td>$1.84\sigma_d$</td> <td>$1.5\sigma_d$</td> </tr> </tbody> </table> <p>Notes:</p> <ol style="list-style-type: none"> 1. σ_d: Following values for steel material, whichever is the smaller <ol style="list-style-type: none"> (1) The value obtained by dividing the yield point or the proof stress of material by 1.5 (N/mm^2) (2) The value obtained by dividing the tensile strength by 1.8 (N/mm^2) 2. The combined stress is to be the value obtained from the following formula: $\sqrt{\sigma_x^2 + \sigma_y^2 - \sigma_x\sigma_y + 3\tau_{xy}^2} \text{ (N/mm}^2\text{)}$ <p>where</p> <ul style="list-style-type: none"> σ_x : Applied stress in x-direction at the middle of plate thickness (N/mm^2) σ_y : Applied stress in y-direction at the middle of plate thickness (N/mm^2) τ_{xy} : Applied shear stress in the x-y plane (N/mm^2) 	Load Condition	Kind of stress							Tension	Bending		Shear	Compression	Bearing	Combined stress	Tension side	Compression side	Condition specified in 4.2.9-2	σ_d	σ_d	$0.87\sigma_d$	$0.58\sigma_d$	$0.87\sigma_d$	$1.41\sigma_d$	$1.15\sigma_d$	Condition specified in 4.2.9-3	$1.15\sigma_d$	$1.15\sigma_d$	σ_d	$0.67\sigma_d$	σ_d	$1.63\sigma_d$	$1.33\sigma_d$	Condition specified in 4.2.9-4 and -5	$1.3\sigma_d$	$1.3\sigma_d$	$1.13\sigma_d$	$0.75\sigma_d$	$1.14\sigma_d$	$1.84\sigma_d$	$1.5\sigma_d$	<p>σ_{ca} : Allowable compressive stress given in Table 4.5 (N/mm^2). For fixed post at the base, however, the allowable stress (N/mm^2) is to be taken equal to the allowable stress in Table 3.1 divided by 1.15.</p>	<p>No change</p>
Load Condition		Kind of stress																																									
		Tension	Bending		Shear	Compression	Bearing	Combined stress																																			
	Tension side		Compression side																																								
Condition specified in 4.2.9-2	σ_d	σ_d	$0.87\sigma_d$	$0.58\sigma_d$	$0.87\sigma_d$	$1.41\sigma_d$	$1.15\sigma_d$																																				
Condition specified in 4.2.9-3	$1.15\sigma_d$	$1.15\sigma_d$	σ_d	$0.67\sigma_d$	σ_d	$1.63\sigma_d$	$1.33\sigma_d$																																				
Condition specified in 4.2.9-4 and -5	$1.3\sigma_d$	$1.3\sigma_d$	$1.13\sigma_d$	$0.75\sigma_d$	$1.14\sigma_d$	$1.84\sigma_d$	$1.5\sigma_d$																																				
<p>4.3.5 Fatigue Strength (Same)</p>	<p>4.3.5 Fatigue Strength Where the influence of repeated stress cannot be neglected, the member is to have an ample strength against fatigue with due consideration for the magnitude and frequency of repeated stress, the form of the member in question, etc.</p>																																										

Amended-Original Requirements Comparison Table (Lifting Appliances and Anchor Handling Winches)

Amended	Original	Remarks
<p>4.3.6 Ensuring stiffness (Same)</p> <p>4.3.7 Minimum Thickness (Same)</p> <p>4.3.8 Strength of Bolts, Nuts and Pins (Same)</p> <p>4.3.9 Fixed Posts* (Same) (Same)</p> <p>4.3.10 Slewing-ring Fixing Bolts 1 Any material having a tensile strength exceeding 1.18 kN/mm^2 and yield stress exceeding 1.06 kN/mm^2 is not to be used for the bolts fixing the slewing-rings except when special considerations have <u>been</u> given to the strength characteristics of the bolts. (Same)</p>	<p>4.3.6 Ensuring stiffness The stiffness of the main structural parts of cranes is to be ensured to prevent bucking and significant deformation.</p> <p>4.3.7 Minimum Thickness The thickness of structural members is not to be less than 6 mm.</p> <p>4.3.8 Strength of Bolts, Nuts and Pins Bolts, nuts and pins are to have sufficient strength for the magnitudes and directions of the loads they are subjected to.</p> <p>4.3.9 Fixed Posts* 1 The fixed posts are to be effectively connected to the hull structure in accordance with the requirements in 3.3.4-1. 2 The upper part of fixed post where the flange is attached is to be sufficiently reinforced by increasing the plate thickness or by providing of brackets.</p> <p>4.3.10 Slewing-ring Fixing Bolts -1 Any material having a tensile strength exceeding 1.18 kN/mm^2 and yield stress exceeding 1.06 kN/mm^2 is not to be used for the bolts fixing the slewing-rings except when special considerations have given to the strength characteristics of the bolts. 2 Special considerations are to be given to the tightening force of fixing bolts.</p>	

Amended-Original Requirements Comparison Table (Lifting Appliances and Anchor Handling Winches)

Amended	Original	Remarks					
<p>(Same)</p>	<p>3 The stress generated in fixing bolts is not to exceed the allowable stress given in Table 4.6 according to the load conditions specified in 4.2.9. In this case, the stress in bolts is taken as the value of the axial compression determined by the following formula divided by the minimum sectional area of fixing bolts.</p> $\frac{4M}{D \cdot N} - \frac{W}{N} (N)$ <p>where</p> <p><i>M</i> : Upsetting moment (<i>N·mm</i>) <i>D</i> : Pitch circle diameter of fixing bolts (<i>mm</i>) <i>N</i> : Number of fixing bolts <i>W</i> : Axial compression on the slewing-ring (<i>N</i>)</p>	<p>No change</p>					
<p align="center">Table 4.6 Allowable Stress of Fixing Bolts σ_a</p> <table border="1"> <thead> <tr> <th align="center">Load condition</th> <th align="center">σ_a</th> </tr> </thead> <tbody> <tr> <td>Condition specified in 4.2.9-2 and -3</td> <td align="center">$0.4\sigma_y$</td> </tr> <tr> <td>Condition specified in 4.2.9-5</td> <td align="center">$0.54\sigma_y$</td> </tr> </tbody> </table> <p>Note: σ_y : The yield point or proof stress of the material (<i>N/mm²</i>)</p>			Load condition	σ_a	Condition specified in 4.2.9-2 and -3	$0.4\sigma_y$	Condition specified in 4.2.9-5
Load condition	σ_a						
Condition specified in 4.2.9-2 and -3	$0.4\sigma_y$						
Condition specified in 4.2.9-5	$0.54\sigma_y$						
<p>4.4 Special Requirements for Track-mounted Cranes</p> <p>4.4.1 Stability* (Same)</p> <p>4.4.2 Prevention of Upsetting The track-mounted cranes are to be designed with sufficient considerations for the stability to prevent upsetting or detaching even if the wheel shafts or wheels are damaged.</p>	<p>4.4 Special Requirements for Track-mounted Cranes</p> <p>4.4.1 Stability* The track-mounted cranes are to have a suffocate stability under the load conditions specified in 4.2.9.</p> <p>4.4.2 Prevention of Upsetting The track-mounted crane are to be designed with sufficient considerations for the stability to prevent upsetting or detaching even if the wheel shafts or wheels are damaged.</p>						

Amended-Original Requirements Comparison Table (Lifting Appliances and Anchor Handling Winches)

Amended	Original	Remarks
<p>4.4.3 Deflection Criteria (Same)</p> <p>4.4.4 Travel Gear (Same)</p> <p>4.4.5 Buffers (Same)</p> <p align="center">Chapter 5 CARGO FITTINGS</p> <p>5.1 General</p> <p>5.1.1 Application (Same)</p>	<p>4.4.3 Deflection Criteria When suspending the safe working load, deflection of the traveling girder of the track-mounted cranes is not to exceed 1/800 of the span between the supporting points.</p> <p>4.4.4 Travel Gear The travel gear is to be securely fixed to the main body of the track-mounted cranes by bolts, welding or pins. The inclinations of hull in service condition and stowage condition are to be taken into consideration.</p> <p>4.4.5 Buffers The track-mounted cranes are to be provided with buffers in accordance with (1) and (2) below, except when automatic system for prevention of collision is provided.</p> <p>(1) At both ends of tracks or any other equivalent positions. These buffers may be replaced by stops of a height not less than 1/2 of the diameter of wheels.</p> <p>(2) Where more than two track-mounted cranes are provided on one track, between these track-mounted cranes.</p> <p align="center">Chapter 5 CARGO FITTINGS</p> <p>5.1 General</p> <p>5.1.1 Application The requirements in this Chapter apply to the cargo fittings.</p>	

Amended-Original Requirements Comparison Table (Lifting Appliances and Anchor Handling Winches)

Amended	Original	Remarks
<p>5.2 Cargo Fittings</p> <p>5.2.1 Goose Neck Brackets and Derrick Heel Lugs (Same)</p> <p>(Same)</p> <p>(Same)</p>	<p>5.2 Cargo Fittings</p> <p>5.2.1 Goose Neck Brackets and Derrick Heel Lugs</p> <p>1 The sizes of goose neck pin, cross bolt and derrick heel lug shown in Fig. 5.1 are to be not less than the following values. The sizes of other parts are to be as deemed appropriate by the Society.</p> $b = e_1 \sqrt{\frac{P}{g}} (mm)$ $c = 0.55e_1 \sqrt{\frac{P}{g}} (mm)$ $d = e_1 \sqrt{\frac{P}{g}} (mm)$ <p>where</p> <p><i>P</i>: Design axial compressive force acting on derrick boom (<i>kN</i>)</p> <p><i>e</i>₁: 15.6. However, in the swinging derrick system, the values given in Table 5.1 may be used according to the safe working load.</p> <p>2 It is recommended that clearance at parts where the cross bolt penetrates through the derrick heel lug and the gooseneck pin of gooseneck bracket is to be less than 2 mm in diameter. The size of the outer parts of bolt holes for the gooseneck pin and derrick heel lug is to be of the same size at the cross bolt radius, as a standard.</p> <p>3 Notwithstanding the requirements in -1, the sizes of gooseneck bracket and derrick heel lug may be in accordance with <i>JIS F 2201, F 2203</i> or any other standards recognized by the Society. However, for the fittings used for other than the swinging derrick systems, consideration to the effect of increasing load caused by the guy ropes is to be given.</p>	

Amended-Original Requirements Comparison Table (Lifting Appliances and Anchor Handling Winches)

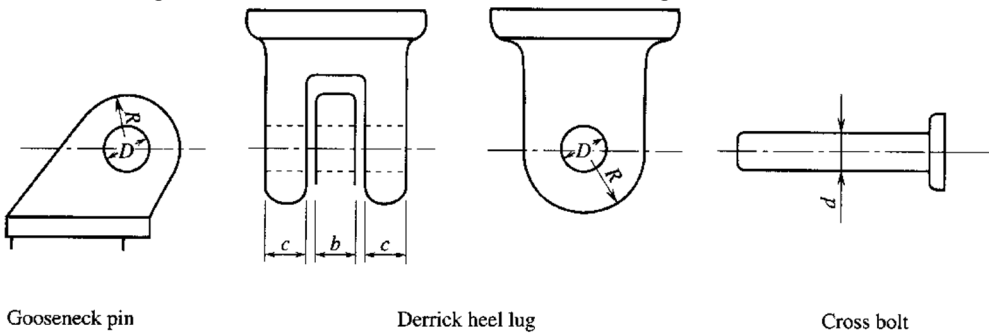
Amended	Original	Remarks										
<p style="text-align: center;">Fig. 5.1 Gooseneck Pin, Derrick Heel Lug and Cross Bolt</p>  <p style="text-align: center;">Table 5.1 Values of e_1</p> <table border="1" data-bbox="481 678 1467 845"> <thead> <tr> <th>Safe working load W (t)</th> <th>e_1</th> </tr> </thead> <tbody> <tr> <td>$W \leq 10$</td> <td>15.6</td> </tr> <tr> <td>$10 < W < 15$</td> <td>$18.8 - 0.32W$</td> </tr> <tr> <td>$15 \leq W \leq 50$</td> <td>14.0</td> </tr> <tr> <td>$50 < W$</td> <td>Value as considered appropriate by the Society</td> </tr> </tbody> </table>		Safe working load W (t)	e_1	$W \leq 10$	15.6	$10 < W < 15$	$18.8 - 0.32W$	$15 \leq W \leq 50$	14.0	$50 < W$	Value as considered appropriate by the Society	<p>No change</p> <p>No change</p>
Safe working load W (t)	e_1											
$W \leq 10$	15.6											
$10 < W < 15$	$18.8 - 0.32W$											
$15 \leq W \leq 50$	14.0											
$50 < W$	Value as considered appropriate by the Society											
<p>5.2.2 Fittings Attached to Head of Derrick Booms (Same)</p>	<p>5.2.2 Fittings Attached to Head of Derrick Booms</p> <p>1 The sizes of fittings attached to the head of derrick booms are not to be less than the values given in the following (1) and (3) according to the respective purpose and shapes of the fittings:</p> <p>(1) Where the shape of cargo fittings attached to the head of derrick boom are as given in Fig.5.2, the sizes of them are not to be less than the following values. The sizes of other parts are to be as deemed appropriate by the Society.</p> $d = e_2 \sqrt{\frac{T}{g}} \text{ (mm)}$											

Amended-Original Requirements Comparison Table (Lifting Appliances and Anchor Handling Winches)

Amended	Original	Remarks
	<p> $t = e_2 \sqrt{\frac{T}{g}} (mm)$ where e_2: Value as given in Table 5.2 T: Maximum tension applied to cargo fitting at the head of derrick boom (kN). However, in the swinging derrick system, the following value may be used: $\alpha_1 \alpha_2 Wg$ for topping lift λWg for cargo fall where W : Safe working load (t) α_1 : As specified in 3.5.2 α_2 : As given in Table 5.3 depending on the value of $l/(h - h')$. However, for intermediate values of α_2, it is to be obtained by interpolation. λ : Value given in Table 5.4 depending on the number of sheaves of blocks for cargo fall. However, the value of λ may be taken as 1.0 where the cargo fall is led to the top of derrick post through the sheave incorporated in the head of the derrick boom. </p> <p>(2) Where the shape of cargo fitting attached to the head of cargo derrick boom is as shown in Fig. 5.3, the sizes of them are not to be less than the following values. The sizes of other parts are to be as deemed appropriate by the Society.</p> <p> $R \geq D$ $t = e_1 \sqrt{\frac{T}{g}} (mm)$ However, where the value of R is larger than $1.15D$, </p>	

Amended-Original Requirements Comparison Table (Lifting Appliances and Anchor Handling Winches)

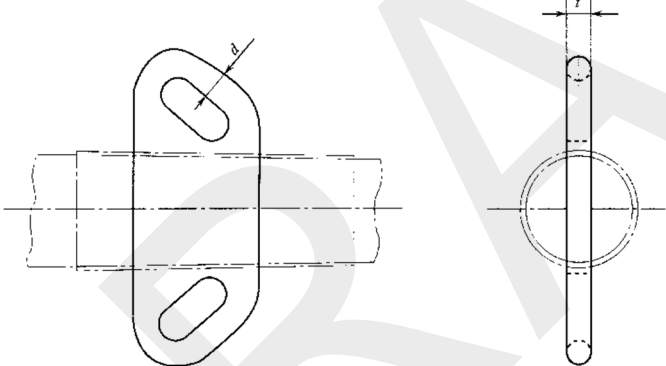
Amended	Original	Remarks										
	<p>the value obtained from the following formula may be taken:</p> $t = \frac{e_3}{\left(R - \frac{D}{2}\right)} \cdot \frac{T}{g} (mm)$ <p>where e_1: As specified in 5.2.1-1 T: As specified in (1) e_3: As given in Table 5.5.</p> <p>(3) The sizes of guy fittings attached the head of derrick boom are to be enough against the design load.</p> <p style="text-align: center;">Fig. 5.2 Cargo Fitting Attached at Head of Derrick Boom</p>  <p style="text-align: center;">Table 5.2 Values of e_2</p> <table border="1" style="margin-left: auto; margin-right: auto;"> <thead> <tr> <th>Safe working load W (t)</th> <th>e_2</th> </tr> </thead> <tbody> <tr> <td>$W \leq 10$</td> <td>12.5</td> </tr> <tr> <td>$10 < W < 15$</td> <td>$15.1 - 0.26W$</td> </tr> <tr> <td>$15 \leq W \leq 50$</td> <td>11.2</td> </tr> <tr> <td>$50 < W$</td> <td>Value as considered appropriate by the Society</td> </tr> </tbody> </table>	Safe working load W (t)	e_2	$W \leq 10$	12.5	$10 < W < 15$	$15.1 - 0.26W$	$15 \leq W \leq 50$	11.2	$50 < W$	Value as considered appropriate by the Society	<p>No change</p> <p>No change</p>
Safe working load W (t)	e_2											
$W \leq 10$	12.5											
$10 < W < 15$	$15.1 - 0.26W$											
$15 \leq W \leq 50$	11.2											
$50 < W$	Value as considered appropriate by the Society											

Amended-Original Requirements Comparison Table (Lifting Appliances and Anchor Handling Winches)

Amended				Original						Remarks
Table 5.3 Values of α_2										No change
	$l/(h - h')$	2.0	1.9	1.8	1.7	1.6	1.5	1.4	1.3	
α_2	$W < 10$	1.99	1.90	1.81	1.73	1.65	1.57	1.49	1.42	1.35
	$15 \leq W < 50$	1.82	1.73	1.65	1.57	1.49	1.41	1.33	1.26	1.19
Note: l, h and h' : As specified in 3.5.2										
Table 5.4 Values of λ										No change
	Sum of the number of sheaves of blocks for cargo fall	1	2	3	4	5	6	7	8	
	λ	2.10	1.58	1.40	1.31	1.26	1.23	1.20	1.18	
(Same)				<p>2 Notwithstanding the requirements in -1, the sizes of cargo fittings attached at the head of derrick boom may be in accordance with <i>JIS F 2201</i> or any other standards recognized by the Society to be equivalent. However, for the fittings used for other than the swinging derrick systems, consideration to the effect of increasing load caused by the guy ropes is to be given.</p>						
5.2.3 Other Cargo Fittings				5.2.3 Other Cargo Fittings						
(Same)				The sizes of the other cargo fittings such as topping bracket, guy cleat, eye and so on, may be in accordance with <i>JIS F 2202</i> . However, for the topping bracket used for other than the swinging derrick systems, consideration to the effect of increasing load caused by the guy ropes is to be given.						

Amended-Original Requirements Comparison Table (Lifting Appliances and Anchor Handling Winches)

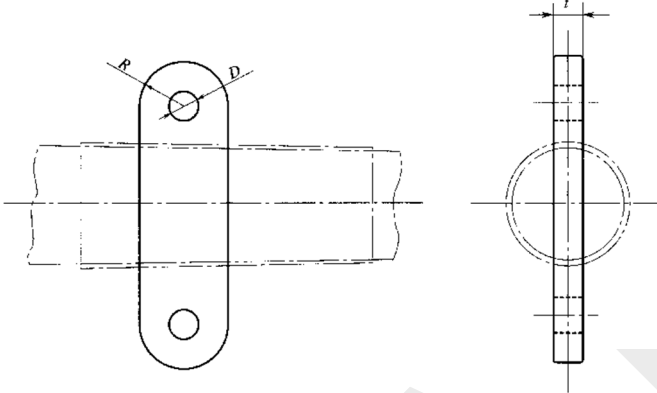
Amended	Original	Remarks										
<p style="text-align: center;">Fig. 5.3 Fitting Attached at Head of Derrick Boom</p> 		No change										
<p style="text-align: center;">Table 5.5 Values of e_3</p> <table border="1" data-bbox="672 758 1281 957"> <thead> <tr> <th>Safe working load W (t)</th> <th>e_3</th> </tr> </thead> <tbody> <tr> <td>$W \leq 10$</td> <td>122</td> </tr> <tr> <td>$10 < W < 15$</td> <td>$170 - 4.8W$</td> </tr> <tr> <td>$15 \leq W \leq 50$</td> <td>98</td> </tr> <tr> <td>$50 < W$</td> <td>Value as considered appropriate by the Society</td> </tr> </tbody> </table>		Safe working load W (t)	e_3	$W \leq 10$	122	$10 < W < 15$	$170 - 4.8W$	$15 \leq W \leq 50$	98	$50 < W$	Value as considered appropriate by the Society	No change
Safe working load W (t)	e_3											
$W \leq 10$	122											
$10 < W < 15$	$170 - 4.8W$											
$15 \leq W \leq 50$	98											
$50 < W$	Value as considered appropriate by the Society											
<p>Chapter 6</p> <p>6.1 General</p> <p>6.1.1 Application (Same)</p>	<p>Chapter 6</p> <p>6.1 General</p> <p>6.1.1 Application The requirements in this Chapter apply to the loose gear.</p>											

Amended-Original Requirements Comparison Table (Lifting Appliances and Anchor Handling Winches)

Amended	Original	Remarks
<p>6.1.2 General Requirements When the safe working load is applied to <u>lifting appliances</u>, the load created in the important part of those loose gear is not to be exceed the respective specified safe working load.</p> <p>6.2 Cargo Blocks</p> <p>6.2.1 Cargo Blocks for Wire Ropes* (Same)</p>	<p>6.1.2 General Requirements When the safe working load is applied to <u>the cargo gear and cargo ramps</u>, the load created in the important part of those loose gears <u>and ropes</u> is not to be exceed the respective specified safe working load.</p> <p>6.2 Cargo Blocks</p> <p>6.2.1 Cargo Blocks for Wire Ropes* The cargo blocks for wire ropes are to comply with the following requirements (1) through (4). However, in sheaves for equalizer sheaves or those for overload sensors, they are to be as deemed appropriate by the Society. (See Fig. 6.1)</p> <ol style="list-style-type: none"> (1) The diameter of the sheave at the bottom of the rope groove is not to be less than 14 times the wire rope diameter. (2) The depth of the groove of the sheave is not to be less than the wire rope diameter. (3) The bottom of the groove of the sheave is to have a circular contour over a segment sustained by angle of not less than 120 <i>degrees</i>. (4) The groove diameter of the sheave is to be 1.1 times the wire rope diameter, as a standard. 	

Amended-Original Requirements Comparison Table (Lifting Appliances and Anchor Handling Winches)

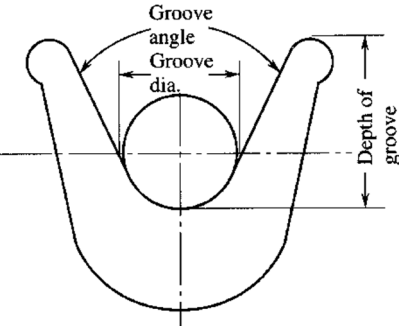
Amended	Original	Remarks
<p data-bbox="817 231 1131 263">Fig. 6.1 Sheave Groove</p>  <p data-bbox="197 667 721 737">6.2.2 Cargo Blocks for Fibre Ropes (Same)</p> <p data-bbox="197 1069 353 1101">6.3 Ropes</p> <p data-bbox="197 1168 492 1238">6.3.1 Wire Ropes* (Same)</p>	<p data-bbox="1025 667 1545 699">6.2.2 Cargo Blocks for Fibre Ropes</p> <p data-bbox="996 705 1792 775">The cargo blocks for fibre ropes are to comply with the following requirements (1) through (3):</p> <ol data-bbox="1025 782 1792 997" style="list-style-type: none"> (1) The diameter of the bottom of the rope groove is not to be less than 5.5 times the fibre rope diameter. (2) The depth of the groove of the sheave is not to be less than the fibre rope diameter. (3) The groove diameter of the sheave is to be the fibre rope diameter plus 2 mm, as a standard. <p data-bbox="1025 1069 1176 1101">6.3 Ropes</p> <p data-bbox="1025 1168 1310 1200">6.3.1 Wire Ropes*</p> <p data-bbox="996 1206 1792 1276">The wire ropes are to comply with the following requirements (1) through (5):</p> <ol data-bbox="1025 1283 1792 1423" style="list-style-type: none"> (1) The wire ropes are to be subjected to suitable corrosion prevention treatment. (2) The wire ropes are to be suitable for the purpose of application, and in addition are to attach a certificate 	<p data-bbox="1814 231 1948 263">No change</p>

Amended-Original Requirements Comparison Table (Lifting Appliances and Anchor Handling Winches)

Amended	Original	Remarks
<p>6.3.2 Fibre Ropes (Same)</p>	<p>stating that they conform to the requirements of Part L of the Rules for the Survey and Construction of Steel Ships or the requirements of the standards as deemed appropriate by the Society.</p> <p>(3) No splicing of the wire ropes is permitted.</p> <p>(4) Terminal connection of wire ropes is to be made in a method approved by the Society to have sufficient strength.</p> <p>(5) The safety factor of the wire ropes is not to be less than the following value according to their purpose and their safe working load. However, the safety factor of the wire ropes for running rigging may not exceed 5, and those for standing rigging, 4.</p> $\frac{10^4}{8.85W+1910} \quad \text{for } W \leq 160$ $3 \quad \text{for } W > 160$ <p>where <i>W</i>: Safe working load (<i>t</i>)</p> <p>6.3.2 Fibre Ropes Fibre ropes are to comply with the following requirements (1) through (3):</p> <p>(1) The fibre ropes are to comply with the recognized standards and to be provided with the certificate deemed appropriate by the Society.</p> <p>(2) The diameter of the fibre ropes is not to be less than 12 mm.</p> <p>(3) The safety factor of fibre ropes is not to be less than the value given in Table 6.1 depending on the rope diameter.</p>	

Amended-Original Requirements Comparison Table (Lifting Appliances and Anchor Handling Winches)

Amended	Original	Remarks												
<p>6.4 Other Loose Gear</p> <p>6.4.1 General The design loads of loose gear such as chains, rings, hooks, shackles, swivels, clamps, grabs, lifting beams, lifting magnets, spreader, etc. are not to be more than the value obtained by dividing the breaking strength of each item of gear by the safety factor of 5, or are to comply with appropriate industry standards.</p> <p>6.5 Equivalent Requirements</p> <p>6.5.1 General* (Same)</p>	<p>6.4 Other Loose Gears</p> <p>6.4.1 General The design loads of loose gears such as chain, rings, hooks, shackles, swivels, clamps, grabs, lifting beams, lifting magnets, spreader, etc. are not to be more than the value obtained by dividing the breaking strength of each gears by the safety factor of 5.</p> <p>6.5 Equivalent Requirements</p> <p>6.5.1 General* Notwithstanding the requirements in 6.2 through 6.4, the constructions of loose gear may be in accordance with any other standards recognized by the Society.</p>	<p>Amends considering the actual situation</p> <p>No change</p>												
<p>Table 6.1 Safety Factor or Fibre Ropes</p> <table border="1"> <thead> <tr> <th align="center">Rope diameter D (mm)</th> <th align="center">Safety Factor</th> </tr> </thead> <tbody> <tr> <td align="center">$12 \leq D < 14$</td> <td align="center">12</td> </tr> <tr> <td align="center">$14 \leq D < 18$</td> <td align="center">10</td> </tr> <tr> <td align="center">$18 \leq D < 24$</td> <td align="center">8</td> </tr> <tr> <td align="center">$24 \leq D < 40$</td> <td align="center">7</td> </tr> <tr> <td align="center">$40 \leq D$</td> <td align="center">6</td> </tr> </tbody> </table>		Rope diameter D (mm)	Safety Factor	$12 \leq D < 14$	12	$14 \leq D < 18$	10	$18 \leq D < 24$	8	$24 \leq D < 40$	7	$40 \leq D$	6	
Rope diameter D (mm)	Safety Factor													
$12 \leq D < 14$	12													
$14 \leq D < 18$	10													
$18 \leq D < 24$	8													
$24 \leq D < 40$	7													
$40 \leq D$	6													

Amended-Original Requirements Comparison Table (Lifting Appliances and Anchor Handling Winches)

Amended	Original	Remarks
<p align="center">Chapter 7 MACHINERY, ELECTRICAL INSTALLATIONS AND CONTROL ENGINEERING SYSTEMS</p> <p>7.1 General</p> <p>7.1.1 Application* The requirements in this Chapter apply to the machinery, electrical installations and control engineering systems used in the <u>lifting</u> appliances. However, in applying the requirements in this Chapter to winches used for cargo ramps, they may be suitably modified.</p> <p>7.2 Machinery</p> <p>7.2.1 General The driving systems of <u>lifting appliances</u> are to be steadily operated in the rated speed under the safe working load.</p> <p>7.2.2 Hoisting and Luffing Winches* (Same)</p>	<p align="center">Chapter 7 MACHINERY, ELECTRICAL INSTALLATIONS AND CONTROL ENGINEERING SYSTEMS</p> <p>7.1 General</p> <p>7.1.1 Application* The requirements in this Chapter apply to the machinery, electrical installations and control engineering systems used in the <u>cargo handling</u> appliances. However, in applying the requirements in this Chapter to winches used for cargo ramps, they may be suitably modified.</p> <p>7.2 Machinery</p> <p>7.2.1 General The driving systems of <u>the cargo handling</u> appliances are to be steadily operated in the rated speed under the safe working load.</p> <p>7.2.2 Hoisting and Luffing Winch* 1 The construction of the winch is to comply with the following requirements (1) through (6): (1) The drum end flange diameter is to have an allowance corresponding to not less than 2.5 times the rope diameter as measured from the outer rim of the outermost layer of ropes in service condition. However, where rope disengagement prevention system is provided or in case of single layer winding</p>	

Amended-Original Requirements Comparison Table (Lifting Appliances and Anchor Handling Winches)

Amended	Original	Remarks
	<p>on the drum, this requirement may be dispensed with.</p> <p>(2) The pitch circle diameter of winch drum is to be not less than 18 times the rope diameter.</p> <p>(3) Winches are to be installed on the winch foundation with foundation bolts having sufficient proof strength against the drum load (the maximum rope tension applied on the drum when the rope is wound under the single winding at a nominal rope hoisting speed) created when the safe working load is applied to the cargo handling appliances.</p> <p>(4) Braking system complying with the following requirements (a) through (c) is to be provided:</p> <p>(a) The braking system is to be able to exert a breaking torque 50% in excess of the torque required when the safe working load is applied to the cargo handling appliances.</p> <p>(b) The power operated braking system is to operate automatically when the manoeuvring is returned to its neutral position.</p> <p>(c) The power operated braking system is to operate automatically when there is any failure in the power supply. In this case, emergency retrieval for cargo lowering is to be provided.</p> <p>(5) Clutchable drums are to be provided with effective locking system capable of restricting rotation of the drum. The locking system is to be, as a rule, capable of resisting the torque not less than 1.5 times the torque required when the safe working load is applied to the cargo handling appliances.</p> <p>(6) Rope guards or suitable other means of protection are to be provided.</p>	

Amended-Original Requirements Comparison Table (Lifting Appliances and Anchor Handling Winches)

Amended	Original	Remarks
(Same)	<p>2 The winding of the wire rope into the winch drum is to comply with the following (1) and (2) except in cases where the winch drum is equipped with the over-winding prevention device.</p> <p>(1) For grooved drums such as a hoisting winch, etc., the angle between the direction in which the wire rope is caught in the groove of the drum and the direction of the wire rope when it is caught in the groove (i.e. the fleet angle) is to be 4° or less.</p> <p>(2) For drums other than grooved drums, the fleet angle is to be 2° or less.</p>	
(Same)	<p>3 The rope at its end is to be secured to the drum in such a manner that will not damage any part of the rope and to have such a length that not less than 3 complete turns in case of an ungrooved drum, or 2 complete turns in case of a grooved drum are remaining on the drum when the complete working length of rope has been paid out.</p>	
7.3 Power Supply	7.3 Power Supply	
7.3.1 General* (Same)	<p>7.3.1 General*</p> <p>1 The equipment, piping and cables consisting of the electric, hydraulic, pneumatic or steam power supply system and their arrangements are, as a rule, to comply with the relevant requirements of the Rules for the Survey and Construction of Steel Ships.</p>	
(Same)	<p>2 The construction, strength, materials, etc. of internal combustion engine used as the prime mover are to comply with the requirements in Part D of the Rules for the Survey and Construction of Steel Ships.</p>	

Amended-Original Requirements Comparison Table (Lifting Appliances and Anchor Handling Winches)

Amended	Original	Remarks
<p>7.4 Control Engineering Systems</p> <p>7.4.1 General (Same)</p> <p>(Same)</p> <p>7.4.2 Control System (Same)</p> <p>(Same)</p> <p>(Same)</p> <p>(Same)</p> <p>(Same)</p> <p>(Same)</p>	<p>7.4 Control Engineering Systems</p> <p>7.4.1 General 1 The electric, hydraulic or pneumatic equipments used for the control, alarm and safety systems are, as a rule, to comply with the relevant requirements of the Rules for the Survey and Construction of Steel Ships. 2 The control, alarm and safety systems are to be designed on the basis of the principle of fail-safe.</p> <p>7.4.2 Control System 1 Control systems are to be so arranged as not interfere with the operator or qualified other personnel giving signals for operation. 2 Control systems are, as a rule, to be of such design that controls automatically return to the neutral position when control operation by the operator is interrupted. 3 For electric winches, local power disconnecting switch is to be provided at the position in the proximity of the place of operation. 4 Cranes and cargo lifts are to be provided with emergency switch capable of stopping all the motions at the position readily accessible for the operator. 5 Cargo lifts are to be provided with a suitable automatic speed control system that reduces the starting acceleration and stopping deceleration as far as practicable. 6 Cargo lifts are to be provided with a suitable control system that stops the lift at the specified deck position.</p>	

Amended-Original Requirements Comparison Table (Lifting Appliances and Anchor Handling Winches)

Amended	Original	Remarks
<p>(Same)</p> <p>(Same)</p> <p>7.4.3 Safety System*</p> <p>1 The <u>lifting</u> appliances are, as a rule, to be provided with an overload protection system.</p> <p>2 In general, the <u>lifting</u> appliances are to be provided with suitable safety systems capable of preventing the abnormalities given in the following (1) through (6) according to kind of appliances and their motion:</p> <ul style="list-style-type: none"> (1) Over hoisting (2) Over slewing (3) Over luffing (4) Excessive travelling speed (5) Over run on the track (6) Other items of abnormality recognized by the Society <p>(Same)</p>	<p>7 Where cargo lifts are secured by locking latches, suitable means is to be provided so as to prevent the impact load to be induced on the lift in case of withdrawal of the latches.</p> <p>8 Control systems for the track-mounted cranes (including their trolleys) are to be provided with braking devices to control travelling except for the human-powered travelling cranes.</p> <p>7.4.3 Safety System*</p> <p>1 The <u>cargo handling</u> appliances are, as a rule, to be provided with an overload protection system.</p> <p>2 In general, the <u>cargo handling</u> appliances are to be provided with suitable safety systems capable of preventing the abnormalities given in the following (1) through (6) according to kind of appliances and their motion:</p> <ul style="list-style-type: none"> (1) Over hoisting (2) Over slewing (3) Over luffing (4) Excessive travelling speed (5) Over run on the track (6) Other items of abnormality recognized by the Society <p>3 In cranes where the safe working load varies according to the operating radius, rating chart showing the relationship between the operating radius and safe working load are to be provided in the control cab and in addition, equipment satisfying the following (1) and (2) or (3) is, as a rule, to be provided:</p> <ul style="list-style-type: none"> (1) Operating radius indicator (2) Hoisting load indicator (3) Overload preventor with respect to the safe working load according to the operating radius 	

Amended-Original Requirements Comparison Table (Lifting Appliances and Anchor Handling Winches)

Amended	Original	Remarks
<p>7.4.4 Protection System (Same)</p> <p>(Same)</p> <p>(Same)</p>	<p>7.4.4 Protection System</p> <p>1 For the rotating parts of the driving machinery, electrical installations and steam pipes, necessary means to protect the operator are to be provided.</p> <p>2 Steam winches are to be arranged not to interfere with the operator's field of vision by the steam.</p> <p>3 Cargo lifts are to be provided with the protection systems given in the following (1) through (4):</p> <p>(1) Protective barriers of a height of not less than 1 <i>m</i> above deck level around the deck opening provided for lift platform.</p> <p>(2) Interlocking system so that cargo lifts cannot be moved unless the barriers are all closed.</p> <p>(3) Interlocking system that prevents opening of protective barriers unless cargo lifts are at the opening position of the barriers.</p> <p>(4) Warning lights or suitable other warning signs at the boarding place of cargo lifts.</p>	
<p>Chapter 8 CARGO LIFTS AND CARGO RAMPS</p> <p>8.1 General</p> <p>8.1.1 Application (Same)</p>	<p>Chapter 8 CARGO LIFTS AND CARGO RAMPS</p> <p>8.1 General</p> <p>8.1.1 Application The provisions in this Chapter apply to the structural members of cargo lifts and cargo ramps.</p>	

Amended-Original Requirements Comparison Table (Lifting Appliances and Anchor Handling Winches)

Amended	Original	Remarks
<p>8.2 Design Loads</p> <p>8.2.1 Load Considerations (Same)</p> <p>8.2.2 Wind Loading (Same)</p> <p>8.2.3 Wave Loading (Same)</p>	<p>8.2 Design Loads</p> <p>8.2.1 Load Considerations Consideration is to be given to the utilization and duty of the particular type of cargo lifts and cargo ramp in the “in service” and stowage conditions with respect to the following loads listed from (1) to (7). (1) Safe working load (2) Self-weight of the installation (3) Wind loading (4) Wave loading (5) Loads due to ship inclination (6) Loads due to ship motion (7) Other loads considered necessary by the Society</p> <p>8.2.2 Wind Loading The wind loading is to be calculated according to 4.2.5.</p> <p>8.2.3 Wave Loading For the structural members forming parts of shell plating and subjected to the wave load, the head of water is not to be less than that obtained from the following formula: $\{d - 0.125D + 0.05L' + \Delta H_w(x)\} \frac{gD}{D+2h_s} (kPa)$ where x: Distance from the forward face of stem on the designed maximum load line defined in 2.1.11(2), Part A of the Rules for the Survey and Construction of Steel Ships (m) d: Designed maximum load draught defined in 2.1.12(2), Part A of the Rules for the Survey and Construction of Steel Ships (m)</p>	

Amended-Original Requirements Comparison Table (Lifting Appliances and Anchor Handling Winches)

Amended	Original	Remarks								
<p>8.2.4 Loads due to Ship Inclination* (Same)</p> <p align="center">Table 8.1 Values of h_s</p> <table border="1" data-bbox="645 1219 1308 1359"> <thead> <tr> <th>Length of ship L (m)</th> <th>h_s</th> </tr> </thead> <tbody> <tr> <td>$L \leq 90$</td> <td>1.95</td> </tr> <tr> <td>$90 < L < 125$</td> <td>$0.01L + 1.05$</td> </tr> <tr> <td>$125 \leq L$</td> <td>2.30</td> </tr> </tbody> </table>	Length of ship L (m)	h_s	$L \leq 90$	1.95	$90 < L < 125$	$0.01L + 1.05$	$125 \leq L$	2.30	<p>D: Depth of ship defined in 2.1.6, Part A of the Rules for the Survey and Construction of Steel Ships (m)</p> <p>L': Length of ship defined in 2.1.2, Part A of the Rules for the Survey and Construction of Steel Ships (m). L' is to be taken as 230 m when the length exceeds 230 m.</p> <p>$\Delta H_w(x)$: Value obtained from the following formula for respective value of x</p> $(38 - 45C'_b) \left(1 - \frac{x}{0.3L}\right)^2 \text{ for } x \leq 0.3L$ $0 \text{ for } x > 0.3L$ <p>C'_b: Block coefficient defined in 2.1.14, Part A of the Rules for the Survey and Construction of Steel Ships. C'_b is to be taken as 0.85 when the block coefficient exceeds 0.85.</p> <p>L: Length of ship defined in 2.1.2, Part A of the Rules for the Survey and Construction of Steel Ships (m)</p> <p>h_s: Value shown in Table 8.1 depending on the length of ship</p> <p>8.2.4 Loads due to Ship Inclination* The loads due to ship inclination are to be as recognized by the Society to be appropriate.</p>	<p>No change</p>
Length of ship L (m)	h_s									
$L \leq 90$	1.95									
$90 < L < 125$	$0.01L + 1.05$									
$125 \leq L$	2.30									

Amended-Original Requirements Comparison Table (Lifting Appliances and Anchor Handling Winches)

Amended	Original	Remarks
<p>8.2.5 Loads due to Ship Motion (Same)</p> <p>8.2.6 Load Combinations (Same)</p> <p>2 The load combinations of the following loads (1) to (5) are to be taken into consideration “in service” conditions:</p> <ul style="list-style-type: none"> (1) Safe working load (2) Self-weight of slewing or moving parts of the cargo lifts and cargo ramps (3) Self-weight of the fixed parts of the cargo lifts and cargo ramps (4) Loads due to ship inclination (5) Other loads considered necessary by the Society <p>(Same)</p>	<p>8.2.5 Loads due to Ship Motion The loads due to ship motion are to be as specified in 4.2.8.</p> <p>8.2.6 Load Combinations</p> <p>1 The load combinations to be used in strength analysis of structural members is to be those causing the more severe loading condition of the structural members resulting from the load combinations specified in -2 to -5 below.</p> <p>2 The load combination of the following loads (1) to (5) are to be taken into consideration “in service” conditions:</p> <ul style="list-style-type: none"> (1) Safe working load (2) Self-weight of slewing or moving parts of the cargo lifts and cargo ramps (3) Self-weight of the fixed parts of the cargo lifts and cargo ramps (4) Loads due to ship inclination (5) Other loads considered necessary by the Society <p>3 The loads -2(1) and (2) are to be multiplied by 1.2 for the installations designed to slew or move with cargo loaded thereon/therein and by 1.1 for the cargo ramps designed not to slew or move with cargo loaded thereon.</p> <p>4 The following loads (1) to (6) are to be taken into consideration for cargo lifts in stowage conditions.</p> <ul style="list-style-type: none"> (1) Loads in stowage conditions (2) Self-weight of the cargo lifts (3) Wind loading (4) Loads due to ship inclinations in navigation (5) Loads due to ship motions in navigation (6) Other loads considered necessary by the Society 	

Amended-Original Requirements Comparison Table (Lifting Appliances and Anchor Handling Winches)

Amended	Original	Remarks
(Same)	<p>5 The following loads (1) to (5) are to be taken into consideration for cargo ramps in stowage conditions.</p> <p>(1) Self-weight of the cargo lifts (2) Wind loading (3) Loads due to ship inclinations in navigation (4) Loads due to ship motions in navigation (5) Other loads considered necessary by the Society</p>	
8.3 Strength and Construction	8.3 Strength and Construction	
8.3.1 General	8.3.1 General	
(Same)	1 The strength of structural members is to be analyzed for the load conditions specified in 8.2.6 according to the requirements in 8.3.2 to 8.3.7.	
(Same)	2 For the installations loaded with vehicles, the concentrated loads from wheels corresponding to their loading or running conditions are to be taken into account.	
(Same)	3 The strength of structural members forming parts of shell plating is, in general, to be equivalent to that of the surrounding hull structure.	
(Same)	4 The structural members are to have proper stiffeners and, in addition, suitable lashing devices for preventing their vertical and horizontal movements when stowed in position.	
8.3.2 Allowable Stress for Loads	8.3.2 Allowable Stress for Loads	
(Same)	The allowable stress prescribed in Table 8.2 is not to be exceeded depending on the type of stress.	

Amended-Original Requirements Comparison Table (Lifting Appliances and Anchor Handling Winches)

Amended	Original	Remarks																																	
<p>Table 8.2 Allowable Stress σ_d</p> <table border="1" style="width:100%; border-collapse: collapse;"> <thead> <tr> <th rowspan="3" style="width:30%;">Load Condition</th> <th colspan="7">Kind of stress</th> </tr> <tr> <th rowspan="2">Tension</th> <th colspan="2">Bending</th> <th rowspan="2">Shear</th> <th rowspan="2">Compression</th> <th rowspan="2">Bearing</th> <th rowspan="2">Combined stress</th> </tr> <tr> <th>Tension side</th> <th>Compression side</th> </tr> </thead> <tbody> <tr> <td>Condition given in 8.2.6-2</td> <td>σ_d</td> <td>σ_d</td> <td>$0.87\sigma_d$</td> <td>$0.58\sigma_d$</td> <td>$0.87\sigma_d$</td> <td>$1.41\sigma_d$</td> <td>$1.15\sigma_d$</td> </tr> <tr> <td>Condition given in 8.2.6-4 and -5</td> <td>$1.15\sigma_d$</td> <td>$1.15\sigma_d$</td> <td>σ_d</td> <td>$0.67\sigma_d$</td> <td>σ_d</td> <td>$1.63\sigma_d$</td> <td>$1.33\sigma_d$</td> </tr> </tbody> </table> <p>Notes:</p> <ol style="list-style-type: none"> σ_d: Following values for steel material, whichever is the smaller <ol style="list-style-type: none"> The value obtained by dividing the yield point or the proof stress of material by 1.5 (N/mm^2) The value obtained by dividing the tensile strength by 1.8 (N/mm^2) The combined stress is to be the value obtained from the following formula: $\sqrt{\sigma_x^2 + \sigma_y^2 - \sigma_x\sigma_y + 3\tau_{xy}^2} \text{ (N/mm}^2\text{)}$ where σ_x: Applied stress in x-direction at the middle of plate thickness (N/mm^2) σ_y: Applied stress in y-direction at the middle of plate thickness (N/mm^2) τ_{xy}: Applied shear stress in the x-y plane (N/mm^2) 		Load Condition	Kind of stress							Tension	Bending		Shear	Compression	Bearing	Combined stress	Tension side	Compression side	Condition given in 8.2.6-2	σ_d	σ_d	$0.87\sigma_d$	$0.58\sigma_d$	$0.87\sigma_d$	$1.41\sigma_d$	$1.15\sigma_d$	Condition given in 8.2.6-4 and -5	$1.15\sigma_d$	$1.15\sigma_d$	σ_d	$0.67\sigma_d$	σ_d	$1.63\sigma_d$	$1.33\sigma_d$	<p>No change</p>
Load Condition	Kind of stress																																		
	Tension		Bending		Shear	Compression	Bearing	Combined stress																											
		Tension side	Compression side																																
Condition given in 8.2.6-2	σ_d	σ_d	$0.87\sigma_d$	$0.58\sigma_d$	$0.87\sigma_d$	$1.41\sigma_d$	$1.15\sigma_d$																												
Condition given in 8.2.6-4 and -5	$1.15\sigma_d$	$1.15\sigma_d$	σ_d	$0.67\sigma_d$	σ_d	$1.63\sigma_d$	$1.33\sigma_d$																												
<p>8.3.3 Lift Deck Plating and Ramp Plating Thickness (Same)</p>	<p>8.3.3 Lift Deck Plating and Ramp Plating Thickness 1 The thickness of the plating forming a part of shell plating is not to be less than the thickness of shell plating at the position concerned to be determined regarding the actual stiffener spacing as the frame spacing. 2 The plate thickness of the plating forming a part of bulkhead is not to be less than the thickness of bulkhead plating at the position concerned to be determined regarding the actual stiffener spacing as the bulkhead stiffener spacing. 3 For the installations loaded with vehicles the thickness of lift deck plating or ramp plating is not to be less than required for deck plating of the car deck.</p>																																		
<p>(Same)</p>																																			
<p>(Same)</p>																																			

Amended-Original Requirements Comparison Table (Lifting Appliances and Anchor Handling Winches)

Amended	Original	Remarks
<p>8.3.4 Minimum Thickness (Same)</p>	<p>8.3.4 Minimum Thickness The thickness of structural members is not to be less than 6 <i>mm</i> in the parts exposed to weather and 5 <i>mm</i> in the parts not exposed to weather.</p>	
<p>8.3.5 Deflection Criteria* (Same)</p>	<p>8.3.5 Deflection Criteria* The deflection of the structural members due to the safe working load is to be limited, as a rule, to 1/400 of the span between supports in cargo lifts and 1/250 of the span between supports in cargo ramps.</p>	
<p>8.3.6 Strength of Bolts, Nuts and Pins (Same)</p>	<p>8.3.6 Strength of Bolts, Nuts and Pins Bolts, nuts and pins are to have ample strength for the magnitudes and directions of the loads they are subjected to.</p>	
<p>8.3.7 Locking Devices of Cargo Ramps (Same)</p>	<p>8.3.7 Locking Devices of Cargo Ramps 1 Stowage locks are to be provided to resist the load resulting from consideration of loads specified in 8.2.6-5.</p>	
<p>(Same)</p>	<p>2 The hydraulic locking devices are to be designed to keep the ramp locked mechanically even in the event of failure of the hydraulic pressure.</p>	
<p>(Same)</p>	<p>3 For a cargo ramp utilized commonly as a means for closing openings, the closing devices may be utilized as locking devices, if the area of opening is larger than half of the projected area of the stowed ramp. The design load of the closing devices is to include also the loads specified in 8.2.6-5 in addition to the loads in 14.10.1.4, Part 1, Part C of the Rules for the Survey and Construction of Steel Ships.</p>	

Amended-Original Requirements Comparison Table (Lifting Appliances and Anchor Handling Winches)

Amended	Original	Remarks
<p>Chapter 9 CERTIFICATION, MARKING AND DOCUMENTATION</p> <p>9.1 General</p> <p>9.1.1 Application The requirements in this chapter apply to the certification, marking and documentation of the <u>lifting appliances and loose gear</u>.</p> <p>9.2 Assignment of Safe Working Load, etc.</p> <p>9.2.1 General The Society assigns the safe working load, etc., for the <u>lifting appliances and loose gear</u> that have passed the inspection and load tests specified in Chapter 2.</p> <p>9.2.2 Duplicated Assignment of Safe Working Load, etc. The Society will assign, at the application of the shipowner, the following (1) to (3) in addition to the safe working load etc. in accordance with the requirements in 9.2.1:</p> <p>(1) The maximum load corresponding to an angle smaller than the assigned allowable minimum angle in case of derrick systems</p> <p>(2) The maximum load corresponding to a radius exceeding the assigned maximum slewing radius in case of jib cranes</p>	<p>Chapter 9 CERTIFICATION, MARKING AND DOCUMENTATION</p> <p>9.1 General</p> <p>9.1.1 Application The requirements in this chapter apply to the certification, marking and documentation of the <u>cargo handling appliances</u>.</p> <p>9.2 Assignment of Safe Working Load, etc.</p> <p>9.2.1 General The Society assigns the safe working load, etc., for the <u>cargo handling appliances</u> that have passed the inspection and load tests specified in Chapter 2.</p> <p>9.2.2 Duplicated Assignment of Safe Working Load, etc. The Society will assign, at the application of the shipowner, the following (1) to (3) in addition to the safe working load etc. in accordance with the requirements in 9.2.1:</p> <p>(1) The maximum load corresponding to an angle smaller than the assigned allowable minimum angle in case of derrick systems</p> <p>(2) The maximum load corresponding to a radius exceeding the assigned maximum slewing radius in case of jib cranes</p>	

Amended-Original Requirements Comparison Table (Lifting Appliances and Anchor Handling Winches)

Amended	Original	Remarks
<p>(3) The maximum load for personnel transfers specified in 1.1.1-9 of the Rules in case of cranes</p> <p>9.2.3 Assignment for Union-purchase Derrick Systems</p> <p>(Same)</p> <p>(Same)</p> <p>9.3 Marking of Safe Working Load, etc.</p> <p>9.3.1 Marking for <u>Lifting Appliances</u></p> <p>1 On the <u>lifting appliances</u> assigned by the requirements specified in 9.2, the safe working load, allowable minimum angle, maximum slewing radius and other restrictive conditions are to be marked by using stamps in accordance with the following requirement in (1) through (3):</p> <p>(1) Derrick systems At the conspicuous place of the base of derrick boom, the stamp mark of the Society, the safe working load, the allowable minimum angle of the boom and other restrictive conditions are to be marked.</p> <p>(2) Jib cranes At the conspicuous place of the base of jib or the</p>	<p>(3) The maximum load for personnel transfers specified in 1.1.1-3 of the Rules in case of cranes</p> <p>9.2.3 Assignment for Union-purchase Derrick Systems</p> <p>1 The assignments of the safe working load, etc. for the union-purchase derrick systems are the safe working load and maximum angle between two cargo falls or the safe working load and allowable lifting height (the vertical distance between the highest position of the structure above the upper deck with hatch opening and the delta plate or ring attached to the cargo falls).</p> <p>2 The maximum angle between two cargo falls specified in -1 is not to be assigned to exceed 120°.</p> <p>9.3 Marking of Safe Working Load, etc.</p> <p>9.3.1 Marking for <u>Cargo Gear and Cargo Ramps</u></p> <p>1 On the <u>cargo gear and cargo ramps</u> assigned by the requirements specified in 9.2, the safe working load, allowable minimum angle, maximum slewing radius and other restrictive conditions are to be marked by using stamps in accordance with the following requirement in (1) through (3):</p> <p>(1) Derrick systems At the conspicuous place of the base of derrick boom, the stamp mark of the Society, the safe working load, the allowable minimum angle of the boom and other restrictive conditions are to be marked.</p> <p>(2) Jib cranes At the conspicuous place of the base of jib or the</p>	<p>Same as MSC.1/Circ.1663 Para3.4.1</p>

Amended-Original Requirements Comparison Table (Lifting Appliances and Anchor Handling Winches)

Amended	Original	Remarks
<p>similar position, the stamp mark of the Society, the safe working load, the maximum slewing radius and other restrictive conditions are to be marked.</p> <p>(3) <u>Cargo lifts, cargo ramps, and lifting appliances other than (1) and (2) above</u> At a conspicuous place which is <u>hard to foul</u>, the stamp mark of the Society, the safe working load and other restrictive conditions are to be marked.</p> <p>2 In the case of the duplicated assignment of safe working loads are assigned to derrick systems and jib cranes in accordance with the requirements of 9.2.2, the necessary markings for respective combinations are to be made correspondingly in according to the requirements of -1. <u>In addition, diagrams of the permissible maximum loads over the entire range of use are to be displayed in position clearly visible to operators.</u></p> <p>3 For the <u>lifting appliance</u> which is used with grabs, lifting beams, lifting magnets, spreaders and similar other loose gear and assigned the maximum cargo load excluding the self-weight of such loose gear to safe working load, the notation in this connection to be marked as other restrictive conditions correspondingly according to -1. (Same)</p> <p>5 In addition to the stamp marks specified in -1, -2 and -3, the same markings (except for the stamp mark of the Society) are to be made so as to be permanently and easily visible at conspicuous places <u>to the operator</u>.</p> <p>6 The size of the letters used in the markings specified in -5 above is not to be less than <u>77 mm</u> in height <u>for derrick systems</u>.</p>	<p>similar position, the stamp mark of the Society, the safe working load, the maximum slewing radius and other restrictive conditions are to be marked.</p> <p>(3) <u>Other cargo gear and cargo ramps</u> At the conspicuous place which is <u>hardly fouled</u>, the stamp mark of the Society, the safe working load and other restrictive conditions are to be marked.</p> <p>2 In the case of the duplicated assignment of safe working loads are assigned to derrick systems and jib cranes in accordance with the requirements of 9.2.2, the necessary markings for respective combinations are to be made correspondingly in according to the requirements of -1.</p> <p>3 For the <u>cargo gear</u> which is used with grabs, lifting beams, lifting magnets, spreaders and similar other loose gear and assigned the maximum cargo load excluding the self-weight of such loose gear to safe working load, the notation in this connection to be marked as other restrictive conditions correspondingly according to -1.</p> <p>4 The stamp marks are to be coated with anti-corrosive paint and framed with paint for easy recognition.</p> <p>5 In addition to the stamp marks specified in -1, -2 and -3, the same markings (except for the stamp mark of the Society) are to be made so as to be permanently and easily visible at conspicuous places <u>using welded bead and paint or methods recognized by the Society to be equivalent</u>.</p> <p>6 The size of the letters used in the markings specified in -5 above is not to be less than <u>77 mm</u> in height.</p>	<p>Adds cargo lifts to align with other requirements</p> <p>Same as MSC.1/Circ.1663 Para3.4.2</p> <p>MSC.1/Circ.1663 Para3.4.1</p> <p>Deletes methods considering ILO requirements Letter size is only required for derrick systems in ILO</p>

Amended-Original Requirements Comparison Table (Lifting Appliances and Anchor Handling Winches)

Amended	Original	Remarks
<p><u>7 The requirement of 1 through 5 above are to be applied when assign the safe working loads in accordance with 2.5.1-3.</u></p> <p>9.3.2 Marking for Loose Gear</p> <p>1 On the loose gear other than wire ropes and fibre ropes, the test load, the safe working load and the identification symbols are to be marked by using stamps at the conspicuous place and no adverse effects are to be caused for both their strength and service.</p> <p><u>2 The following minimum information is to be marked using stamps according to the specific type of loose gear in addition to 1 above.</u></p> <p>(1) <u>Ramshorn hooks</u> <u>Range of sling angle</u></p> <p>(2) <u>Block and hook blocks</u> <u>Rope diameter</u> <u>Rigging plan identification mark for blocks, if any.</u></p> <p>(3) <u>Lifting beams, spreaders and frames</u> <u>Tare weight</u> <u>Allowable sling angles</u> <u>Details of the safe application of the SWL in case of compex equipment which can be utilized in different ways</u></p> <p>(4) <u>Grabs</u> <u>Tare weight</u></p> <p>(5) <u>Other</u></p>	<p>(Newly added)</p> <p>9.3.2 Marking for Loose Gear</p> <p>1 On the loose gear other than wire ropes and fibre ropes, the test load, the safe working load and the identification symbols are to be marked by using stamps at the conspicuous place and no adverse effects are to be caused for both their strength and service. <u>On grabs, lifting beams, lifting magnets, spreaders and similar other loose gear, the self-weight of them are to be stamped additionally.</u></p> <p>(Newly added)</p>	<p>requirements</p> <p>MSC.1/Circ.1663 Para3.4.3</p> <p>MSC.1/Circ.1663 Para4.4 MSC.1/Circ.1663 Para4.4.1</p> <p>Transfers to -2</p> <p>MSC.1/Circ.1663 Para4.4.2</p>

Amended-Original Requirements Comparison Table (Lifting Appliances and Anchor Handling Winches)

Amended	Original	Remarks
<p><u>As per industry standards acceptable to the Administration</u></p> <p>3 The stamp marks are to be coated with anti-corrosive paint and framed with paint for easy recognition.</p> <p>4 In addition to the markings specified in -1, grabs, lifting beams, lifting magnets, spreaders and similar other loose gear are to be marked with the safe working load and the self-weight of them with paint, etc.</p> <p>5 Notwithstanding the requirements in -1 <u>through -4</u>, where it is difficult to make direct stamp mark or marking with paint, <u>these indomation may be included in the relevant certificates or other means may be taken when approved by the Society.</u></p> <p>9.4 Documentation</p> <p>9.4.1 Kinds of Documents</p> <p>The kinds of the documents issued by the Society for <u>lifting appliances</u> and loose gear are to be as specified in the followings:</p> <ol style="list-style-type: none"> (1) Register of Ship's Lifting Appliances and Items of Loose Gear (<i>ILO Form 1</i>) (CG.1) (2) Certificate of Test and Thorough Examination of Derricks, Winches and their Accessory Gear (<i>ILO Form 2</i>) (CG.2) (3) Certificate of Test and Thorough Examination of Derricks, Winches and their Accessory Gear, for Operation in Union Purchase (<i>ILO Form 2 (U)</i>) (CG.2(U)) 	<p>2 The stamp marks are to be coated with anti-corrosive paint and framed with paint for easy recognition.</p> <p>3 In addition to the markings specified in -1, grabs, lifting beams, lifting magnets, spreaders and similar other loose gear are to be marked with the safe working load and the self-weight of them with paint, etc. <u>In this case the size of letters should not be less than 77 mm in height.</u></p> <p>4 Notwithstanding the requirements in -1 <u>and -3</u>, where it is difficult to make direct stamp mark or marking with paint, other means may be taken when approved by the Society.</p> <p>9.4 Documentation</p> <p>9.4.1 Kinds of Documents</p> <p>The kinds of the documents issued by the Society for <u>cargo gears, cargo ramps</u> and loose gear are to be as specified in the followings:</p> <ol style="list-style-type: none"> (1) Register of Ship's Lifting Appliances and Items of Loose Gear (<i>ILO Form 1</i>) (CG.1) (2) Certificate of Test and Thorough Examination of Derricks, Winches and their Accessory Gear (<i>ILO Form 2</i>) (CG.2) (3) Certificate of Test and Thorough Examination of Derricks, Winches and their Accessory Gear, for Operation in Union Purchase (<i>ILO Form 2 (U)</i>) (CG.2(U)) 	<p>Deletes considering ILO requirements</p> <p>MSC.1/Circ.1663 Para4.4.3</p> <p>Same as MSC.1/Circ.1663 Para3.2.3.2</p>

Amended-Original Requirements Comparison Table (Lifting Appliances and Anchor Handling Winches)

Amended	Original	Remarks
(4) Certificate of Test and Thorough Examination of Cranes or Hoists and their Accessory Gear (<i>ILO Form 2</i>) (CG.3)	(4) Certificate of Test and Thorough Examination of Cranes or Hoists and their Accessory Gear (<i>ILO Form 2</i>) (CG.3)	Adds a statement covering existing lifting appliances which does not have a valid certificate of load testing and thorough examination issued under other international recognized standards by the Administration (e.g. the ILO152 Convention).
(5) Certificate of Test and Thorough Examination of Cargo Lifts/Cargo Ramps and their Accessory Gear (CG.3LR)	(5) Certificate of Test and Thorough Examination of Cargo Lifts/Cargo Ramps and their Accessory Gear (CG.3LR)	
(6) Certificate of Test and Thorough Examination of Loose Gear (<i>ILO Form 3</i>) (CG.4)	(6) Certificate of Test and Thorough Examination of Loose Gear (<i>ILO Form 3</i>) (CG.4)	
(7) Certificate of Test and Thorough Examination of Wire Rope (<i>ILO Form 4</i>) (CG.5)	(7) Certificate of Test and Thorough Examination of Wire Rope (<i>ILO Form 4</i>) (CG.5)	
(8) <u>Factual Statement of the Test and Thorough Examination of Non-Certified Existing Lifting Appliance</u>		

Amended-Original Requirements Comparison Table (Lifting Appliances and Anchor Handling Winches)

Amended	Original	Remarks														
<p>9.4.2 Timing of Issuance of Documents (Same)</p>	<p>9.4.2 Timing of Issuance of Documents The timing of issuance of documents specified in 9.4.1 is to be as given in Table 9.1 depending on the tests and survey.</p>															
<p>Table 9.1 Timing of Issuance</p>																
<table border="1" style="width: 100%; border-collapse: collapse;"> <thead> <tr> <th style="width: 15%;">Kind of Documents</th> <th style="width: 85%;">Timing of Issuance</th> </tr> </thead> <tbody> <tr> <td style="text-align: center;">A</td> <td>Document in 9.4.1(1) When the application for assignment is made and the ship passes the Registration Survey for the first time</td> </tr> <tr> <td rowspan="4" style="text-align: center;">B</td> <td>Document in 9.4.1(2) (1) When the application for assignment is made, and the ship passes the Registration Survey for the first time</td> </tr> <tr> <td>Document in 9.4.1(3) (2) When the cargo handling lifting appliances and loose gear that are installed additionally pass the Registration Survey</td> </tr> <tr> <td>Document in 9.4.1(4) (3) When the safe working load, etc. is altered</td> </tr> <tr> <td>Document in 9.4.1(5) (4) When the ship passes the load tests specified in 2.5.1-45</td> </tr> <tr> <td rowspan="2" style="text-align: center;">C</td> <td>Document in 9.4.1(6) (1) When the application for assignment is made, and the ship passes the Registration Survey for the first time (2) When the cargo handling lifting appliances and loose gear that are installed additionally pass the Registration Survey</td> </tr> <tr> <td>Document in 9.4.1(7) (3) When loose gear is replaced or repair at time of the Periodical Surveys and the Occasional Survey, and when the contents of autonomous inspection is recognized appropriate by the Society</td> </tr> <tr> <td style="text-align: center;">D</td> <td>Document in 9.4.1(8) <u>When the ship passes the load tests specified in 2.5.1-3 but does not have the valid certificate specified in 1.1.1-5(1)</u></td> </tr> </tbody> </table>			Kind of Documents	Timing of Issuance	A	Document in 9.4.1(1) When the application for assignment is made and the ship passes the Registration Survey for the first time	B	Document in 9.4.1(2) (1) When the application for assignment is made, and the ship passes the Registration Survey for the first time	Document in 9.4.1(3) (2) When the cargo handling lifting appliances and loose gear that are installed additionally pass the Registration Survey	Document in 9.4.1(4) (3) When the safe working load, etc. is altered	Document in 9.4.1(5) (4) When the ship passes the load tests specified in 2.5.1-4 5	C	Document in 9.4.1(6) (1) When the application for assignment is made, and the ship passes the Registration Survey for the first time (2) When the cargo handling lifting appliances and loose gear that are installed additionally pass the Registration Survey	Document in 9.4.1(7) (3) When loose gear is replaced or repair at time of the Periodical Surveys and the Occasional Survey, and when the contents of autonomous inspection is recognized appropriate by the Society	D	Document in 9.4.1(8) <u>When the ship passes the load tests specified in 2.5.1-3 but does not have the valid certificate specified in 1.1.1-5(1)</u>
Kind of Documents	Timing of Issuance															
A	Document in 9.4.1(1) When the application for assignment is made and the ship passes the Registration Survey for the first time															
B	Document in 9.4.1(2) (1) When the application for assignment is made, and the ship passes the Registration Survey for the first time															
	Document in 9.4.1(3) (2) When the cargo handling lifting appliances and loose gear that are installed additionally pass the Registration Survey															
	Document in 9.4.1(4) (3) When the safe working load, etc. is altered															
	Document in 9.4.1(5) (4) When the ship passes the load tests specified in 2.5.1-4 5															
C	Document in 9.4.1(6) (1) When the application for assignment is made, and the ship passes the Registration Survey for the first time (2) When the cargo handling lifting appliances and loose gear that are installed additionally pass the Registration Survey															
	Document in 9.4.1(7) (3) When loose gear is replaced or repair at time of the Periodical Surveys and the Occasional Survey, and when the contents of autonomous inspection is recognized appropriate by the Society															
D	Document in 9.4.1(8) <u>When the ship passes the load tests specified in 2.5.1-3 but does not have the valid certificate specified in 1.1.1-5(1)</u>															
<p>9.4.3 Revocation of the Documents 1 The whole or part of the certificates specified in 9.4.1 will be revoked when either of the following (1) through (9) is relevant: (1) When application is made by the shipowner for cancellation or alteration of the assignment of the safe</p>	<p>9.4.3 Revocation of the Documents 1 The whole or part of the certificates specified in 9.4.1 will be revoked when either of the following (1) through (9) is relevant: (1) When application is made by the shipowner for cancellation or alteration of the assignment of the safe</p>															

Amended-Original Requirements Comparison Table (Lifting Appliances and Anchor Handling Winches)

Amended	Original	Remarks
<p>working load, etc.</p> <p>(2) When the construction, arrangement or rigging of the <u>lifting appliances and loose gear</u> are altered</p> <p>(3) When the <u>lifting appliances and loose gear</u> are removed</p> <p>(4) When the surveys specified in Chapter 2 are not subjected to</p> <p>(5) When the <u>lifting appliances and loose gear</u> are considered to be unserviceable by the Surveyor</p> <p>(6) When the contents of certificates are intentionally altered</p> <p>(7) When the contents in the certificates have become illegible due to foul or damage</p> <p>(8) When the specified fee covering the survey is not paid</p> <p>(9) In case where the Society has a doubt on the effectiveness of the certificates, etc.</p> <p>(Same)</p> <p>9.4.4 Reissuance and Corrections of Documents (Same)</p>	<p>working load, etc.</p> <p>(2) When the construction, arrangement or rigging of the <u>cargo handling appliances</u> are altered</p> <p>(3) When the <u>cargo handling appliances</u> are removed</p> <p>(4) When the surveys specified in Chapter 2 are not subjected to</p> <p>(5) When the <u>cargo handling appliances</u> are considered to be unserviceable by the Surveyor</p> <p>(6) When the contents <u>is the</u> certificates are intentionally altered</p> <p>(7) When the contents in the certificates have become illegible due to foul or damage</p> <p>(8) When the specified fee covering the survey is not paid</p> <p>(9) In case where the Society has a doubt on the effectiveness of the certificates, etc.</p> <p>2 The certificates which become invalid in accordance with the provisions in -1 are to be returned to the Society without delay.</p> <p>9.4.4 Reissuance and Corrections of Documents In case where the certificates, etc. become invalid in accordance with the provisions of the preceding 9.4.3-1 or lost, the Society will reissue the certificates or make necessary corrections thereto depending on the circumstances involved.</p>	

Amended-Original Requirements Comparison Table (Lifting Appliances and Anchor Handling Winches)

Amended	Original	Remarks
<p><u>9.4.5</u> Preservation of Documents</p> <p>(Deleted) The Certificates issued by the Society and the others are to be preserved aboard the ship or by shipowner's responsible person in case of towing boat not manned.</p> <p>(Deleted) (Deleted)</p>	<p><u>9.5</u> Preservation of Documents</p> <p><u>9.5.1</u> General The Certificates issued <u>depend on the requirements in 9.4</u> by the Society and <u>the instruction manual for cargo handling appliances</u> are to be preserved aboard the ship or by shipowner's responsible person in case of towing boat not manned.</p> <p><u>9.5.2</u> Instruction Manual The instruction manual mentioned in 9.5.1 is to note essential items necessary for operation and maintenance of the cargo handling appliances among those given in the following (1) through (8):</p> <ol style="list-style-type: none"> (1) General arrangement of cargo gear and cargo ramps (2) Arrangement drawing of loose gear (including rigging arrangement) (3) List of loose gear (4) Design conditions (including safe working load, wind speed, trim and heel of ship, etc.) (5) List of materials (6) Operation manual (including functions of safety systems and protective systems) (7) Load testing procedure (8) Maintenance and control procedures 	<p>Same as MSC.1/Circ.1663 Para.3.2.3.1</p> <p>Transfers to Chapter 10</p>

Amended-Original Requirements Comparison Table (Lifting Appliances and Anchor Handling Winches)

Amended	Original	Remarks
<p><u>Chapter 10 OPERATIONS, MAINTENANCE, INSPECTION AND OPERATIONAL TESTING</u></p> <p><u>10.1 General</u></p> <p><u>10.1.1 General</u> <u>This chapter describes the matters to be observed by the ship owners or ship operators responsible for ships.</u></p> <p><u>10.1.2 Operations and Maintenance Manuals</u> <u>Operations and maintenance manuals noting essential items among the following (1) through (8) necessary for operation and maintenance of the lifting appliances and loose gear are to be kept on board the ship:</u></p> <ul style="list-style-type: none"> <u>(1) General arrangement of lifting appliances</u> <u>(2) Arrangement drawings of loose gear (including rigging arrangements)</u> <u>(3) List of loose gear</u> <u>(4) Design conditions (including safe working loads, wind speeds, trim and heel of ships, etc.)</u> <u>(5) List of materials</u> <u>(6) Operations manual (including functions of safety systems and protective systems)</u> <u>(7) Load testing procedures</u> <u>(8) Maintenance manuals</u> 	<p>(Newly added)</p>	<p>Transferred from 9.5.2</p> <p>MSC.1/Circ.1663 Para.3.3.5</p>

Amended-Original Requirements Comparison Table (Lifting Appliances and Anchor Handling Winches)

Amended	Original	Remarks
<p><u>10.2 Lifting appliances</u></p> <p><u>10.2.1 Maintenance, Inspection and Operational Testing</u></p> <p><u>1 Maintenance, inspection, operational testing and their respective intervals are to be in accordance with manufacturer recommendations, industry standards and guidelines and recommendations acceptable to the Administration in consideration of factors such as the operational profile of the ship and the lifting appliance.</u></p> <p><u>2 All lifting appliances are to be considered vulnerable to marine environmental conditions which may lead to significant and accelerated deterioration and corrosion, and an inspection and maintenance regime is to be implemented accordingly.</u></p> <p><u>3 The inspection and maintenance of lifting appliances may involve working at heights, enclosed space entries and other hazards. These hazards are to be considered when developing relevant procedures for undertaking such tasks, including safe access.</u></p> <p><u>4 Particular attention is to be paid to the following (1) thorough (6).</u></p> <p><u>(1) Corrosion and damage of primary structural members, including crane jibs, crane housings (slewing column), pedestals and foundations or foundation connections, including welds and bolts</u></p> <p><u>(2) Wear, corrosion and damage of mechanical components, including winches, hydraulic cylinders, slew bearings, sheaves and pins</u></p> <p><u>(3) Correct setting and functioning of safety, protection and limitation devices</u></p> <p><u>(4) Condition and correct functioning of the lifting</u></p>		<p>MSC.1/Circ.1663 Para.3.5</p> <p>MSC.1/Circ.1663 Para.3.5.1.1</p> <p>MSC.1/Circ.1663 Para.3.5.1.2</p> <p>MSC.1/Circ.1663 Para.3.5.1.3</p> <p>MSC.1/Circ.1663 Para.3.5.1.4</p>

Amended-Original Requirements Comparison Table (Lifting Appliances and Anchor Handling Winches)

Amended	Original	Remarks
<p><u>appliance as a whole and, in particular, hydraulic or pneumatic arrangements, hydraulic or pneumatic cylinders, motors, hoses, piping, winches, brakes and drums</u></p> <p><u>(5) Corrosion and damage to all means of safe access to the lifting appliances including attached maintenance platforms and extensions, with particular attention paid to support brackets and welds</u></p> <p><u>(6) Certification and identification of ropes</u></p> <p><u>5 Damaged, broken, worn or corroded ropes, including their terminations, are to be inspected and discarded according to manufacturer recommendations, relevant industry standards, international standards (e.g. ISO 4309:2017 on Cranes – Wire ropes – Care and maintenance, inspection and discard).</u></p> <p><u>6 In upon the completion of an inspection, the responsible person considers the lifting appliance to be unsafe for operation or otherwise not in compliance with the applicable requirements of the Administration, said lifting appliance is to be taken out of service until any deficiency is rectified to the satisfaction of a competent person. The lifting appliances are to be clearly marked “not to be used” and the status is to be recorded in the “Register of Ship’s Lifting Appliances and Loose Gear”. While out of service, the relevant actions for inoperative lifting appliances as outlined in 2.1.6 are to be followed.</u></p> <p><u>10.2.2 Maintenance Manuals</u></p> <p><u>1 The maintenance manual for a lifting appliance specified in 10.1.2(8) is to be provided by its manufacturer. Where maintenance manuals for lifting appliances installed before 1 January 2026 are not available from manufacturers, they are to be provided by competent third parties.</u></p>		<p>MSC.1/Circ.1663 Para.3.5.1.5</p> <p>MSC.1/Circ.1663 Para.3.5.1.6</p> <p>MSC.1/Circ.1663 Para.3.5.2 MSC.1/Circ.1663 Para.3.5.2.1</p>

Amended-Original Requirements Comparison Table (Lifting Appliances and Anchor Handling Winches)

Amended	Original	Remarks
<p><u>2 The maintenance manual is, at a minimum, to include the following for each lifting appliance.</u></p> <ul style="list-style-type: none"> <u>(1) Description of the required inspection regime and maintenance schedules specific to the lifting appliance, checklists and a list of key tools or other items for use when carrying out inspections and maintenance</u> <u>(2) Instructions for routine repairs and maintenance</u> <u>(3) Technical maintenance information</u> <u>(4) Information on recommended lubricants, oil and filter change</u> <u>(5) Information on slewing bearing maintenance, if applicable</u> <u>(6) Lists of replaceable parts and components and the inspection, maintenance, and replacement procedures for said parts and components</u> <u>(7) Lists of sources of spare parts</u> <u>(8) Model forms for records of inspections and maintenance</u> <u>(9) Operational test procedures, as well as the pre and post-operational test inspection procedures</u> <u>(10) List of components requiring particular attention during inspections and the inspection and maintenance procedures for said components</u> <u>(11) Recommended intervals for replacement and overhaul of components and equipment</u> <u>(12) Information on the preservation of coatings and corrosion protection systems</u> <u>(13) Information regarding special inspections and maintenance in cases where the lifting appliance is not operated for long periods of time</u> 		<p>MSC.1/Circ.1663 Para.3.5.2.2</p>

Amended-Original Requirements Comparison Table (Lifting Appliances and Anchor Handling Winches)

Amended	Original	Remarks
<p><u>10.2.3 Records of Inspections and Maintenance</u></p> <p><u>1 Records of the routine inspections and maintenance of lifting appliances or their components and parts are to be maintained and kept on board.</u></p> <p><u>2 Records and particulars of inspection and maintenance may be documented in any convenient form, provided each entry contains the necessary information, is clearly legible and is authenticated by a responsible person. Manufacturer recommendations, if any, for said inspection and maintenance records are to be followed.</u></p> <p><u>10.2.4 Operations</u></p> <p><u>1 Personnel operating lifting appliances are to be qualified, familiarized with the equipment and authorized by the master.</u></p> <p><u>2 Personnel involved in lifting operations are to understand their roles during said operations and, in particular, the signals that may be required to commence, coordinate or stop the operation.</u></p> <p><u>3 Personnel involved in lifting operations are to be equipped with appropriate personal protective equipment for the task.</u></p> <p><u>4 Lifting operations are to be planned, supervised and carried out so that any identified risks are minimized.</u></p> <p><u>5 Procedures and instructions are to be related to the specific type of lifting appliance and are to be provided in the operations manual.</u></p> <p><u>6 Due consideration is to be given to any limiting conditions such as ship's motions and inclination, wind speeds including wind gusts, environmental conditions such as ice and snow, limitations such as SWL and the slew radius, etc.</u></p>		<p>MSC.1/Circ.1663 Para.3.5.3 MSC.1/Circ.1663 Para.3.5.3.1</p> <p>MSC.1/Circ.1663 Para.3.5.3.2</p> <p>MSC.1/Circ.1663 Para.3.6 MSC.1/Circ.1663 Para.3.6.1.1</p> <p>MSC.1/Circ.1663 Para.3.6.1.2</p> <p>MSC.1/Circ.1663 Para.3.6.1.3</p> <p>MSC.1/Circ.1663 Para.3.6.1.4 MSC.1/Circ.1663 Para.3.6.1.5</p> <p>MSC.1/Circ.1663 Para.3.6.1.6</p>

Amended-Original Requirements Comparison Table (Lifting Appliances and Anchor Handling Winches)

Amended	Original	Remarks
<p><u>7</u> Effective communication is to be established between ship personnel and shore-based personnel involved in lifting operations.</p> <p><u>8</u> Safe means of access to lifting appliances and loads requiring attachment or detachment are to be established. Safe areas for the signaller and slinger are to be made available.</p> <p><u>9</u> When developing plans and procedures for lifting operations, consideration is to be given to avoiding any part of the lifting appliances striking any person or other structures in close proximity.</p> <p><u>10</u> Procedures and measures for the safe operation of lifting appliances are to take into account applicable international and national instruments and best practices for occupational safety and health.</p> <p><u>11</u> Lifting appliances are to be restrained and stowed in order to avoid uncontrolled movement during voyage. Stowage and restraining arrangements are to be as required by manufacturers.</p> <p><u>12</u> Personnel operating the lifting appliance are to consult the operations manual for any specific instructions related to the lifting operations.</p> <p><u>10.2.5 Operations Manual</u></p> <p><u>1</u> The operations manual for a lifting appliance appliance specified in <u>10.1.2(6)</u> is to be provided by its manufacturer. Where operations manuals for lifting appliances installed before 1 January 2026 are not available from manufacturers, they are to be provided by competent third parties.</p> <p><u>2</u> The operations manual is, at a minimum, to include the following for each lifting appliance.</p> <p>(1) <u>Design, operational and environmental limitations</u></p>		<p>MSC.1/Circ.1663 Para.3.6.1.7</p> <p>MSC.1/Circ.1663 Para.3.6.1.8</p> <p>MSC.1/Circ.1663 Para.3.6.1.9</p> <p>MSC.1/Circ.1663 Para.3.6.1.10</p> <p>MSC.1/Circ.1663 Para.3.6.1.11</p> <p>MSC.1/Circ.1663 Para.3.6.1.12</p> <p>MSC.1/Circ.1663 Para.3.6.2 MSC.1/Circ.1663 Para.3.6.2.1</p> <p>MSC.1/Circ.1663 Para.3.6.2.2</p>

Amended-Original Requirements Comparison Table (Lifting Appliances and Anchor Handling Winches)

Amended	Original	Remarks
<p>(2) <u>Compatible loose gear</u> (3) <u>Safety instructions</u> (4) <u>Operating procedures, including special procedures, if any</u> 3 <u>For lifting appliances installed before 1 January 2026, operations manuals are to be developed with original manufacture, design and build data and take into account any modifications since installation. Where original data or modification data is not available, operations manuals are to be developed based on the current operational procedures and practices.</u></p> <p><u>10.3 loose Gear</u></p> <p><u>10.3.1 Maintenance and Inspection</u> 1 <u>Loose gear is to be inspected by a responsible person before each use.</u> 2 <u>Particular attention is to be paid to the following (1) thorough (4).</u> (1) <u>Wear, corrosion, damage and correct functioning of loose gear</u> (2) <u>Damaged, worn or corroded chains, including their terminations</u> (3) <u>Certification and identification of loose gear</u> (4) <u>Physical or chemical degradation, including degradation due to the exposure to the environment</u> 3 <u>In addition to 1 and 2 above, “lifting appliance” is to be read as “loose gear” and 10.2.1-1 through -3 and 10.2.1-6 are to be applied.</u></p>		<p>MSC.1/Circ.1663 Para.3.6.2.3</p> <p>MSC.1/Circ.1663 Para.4.6 MSC.1/Circ.1663 Para.4.6.4 MSC.1/Circ.1663 Para.4.6.5</p> <p>MSC.1/Circ.1663 Para.4.6.1, 4.6.2, 4.6.3, 4.6.6</p>

Amended-Original Requirements Comparison Table (Lifting Appliances and Anchor Handling Winches)

Amended	Original	Remarks
<p><u>10.3.2 Operation</u> <u>Personnel involved in lifting operations which utilize loose gear are to be qualified, familiarized with the equipment and authorized by the master.</u></p> <p><u>10.3.3 Records of inspection and maintenance</u> <u>“Lifting appliance” is to be read as “loose gear” and 10.2.3 is to apply.</u></p>		<p>MSC.1/Circ.1663 Para.4.5 MSC.1/Circ.1663 Para.4.5</p> <p>MSC.1/Circ.1663 Para.4.7.2 MSC.1/Circ.1663 Para.4.7.2.1, 4.7.2.2</p>

DRAFT

Amended-Original Requirements Comparison Table (Lifting Appliances and Anchor Handling Winches)

Amended	Original	Remarks
<p><u>Part 2 ANCHOR HANDLING WINCHES</u></p> <p><u>Chapter 1 GENERAL</u></p> <p><u>1.1 General</u></p> <p><u>1.1.1 Application</u></p> <p><u>1 Part 2 of the Rules for Lifting Appliances and Anchor handling Winches (hereinafter referred to as “the Rules”) applies to anchor handling winches and gear which are installed on the ships of not less than 500 gross tonnage engaged on international voyages, that are classed with the NIPPON KAIJI KYOKAI (hereinafter referred to as “the Society”), and that are intended to be registered under Chapter 3 of the Regulations for the Classification and Registry of Ships.</u></p> <p><u>2 Anchor handling winches installed on or after 1 January 2026 covered by -1 above, are to be designed, constructed, installed and tested in accordance with this Part 2 and to the satisfaction of the Administration.</u></p> <p><u>3 Anchor handling winches installed before 1 January 2026 covered by -1 above, are to be periodically tested and thoroughly examined in accordance with this Part 2 no later than the date of the first renewal survey on or after 1 January 2026. However, such tests and examinations may be omitted for anchor handling winches with valid certificates of test and thorough examinations under another international instrument acceptable to the Administration that are issued prior to 1 January 2026.</u></p>	<p align="center">(Newly Added)</p>	<p>Specifies requirements for anchor handling winches as Part 2</p> <p>Not limited to winches installed on anchor handling vessels in Part O of the Rules.</p> <p>SOLAS II-1/3-13.2.2 MSC.1/Circ.1662 Para3.3.1, 4.3.1</p> <p>SOLAS II-1/3-13.2.5 MSC.1/Circ.1662 Para3.3.2, 3.3.3, 4.3.1, 4.3.2</p>

Amended-Original Requirements Comparison Table (Lifting Appliances and Anchor Handling Winches)

Amended	Original	Remarks
<p><u>4</u> Anchor handling winches installed on or after 1 January 2026 referred to in -2 above means the following.</p> <p>(1) for ships the keel of which is laid or which is at a similar stage of construction on or after 1 January 2026, any installation date on the ship; or</p> <p>(2) for ships other than those specified in above (1), a contractual delivery date for anchor handling winches, or in the absence of a contractual delivery date, the actual delivery date of the anchor handling winches to the ship on or after 1 January 2026.</p> <p><u>5</u> Anchor handling winches, regardless of installation date, and gears utilized with the anchor handling winches are to be operationally tested, thoroughly examined, inspected, operated and maintained, based on this Part 2.</p> <p><u>6</u> Anchor handling winches and gear other than -1 above are to comply with requirements of the Administration. In the absence of the requirements of the Administration, Part 2 may also be applied to the anchor handling winches and gear based on the application.</p> <p><u>1.2 Definitions</u></p> <p><u>1.2.1 Terminology</u></p> <p>For the purpose of this Part 2, relevant terms are as defined in the following (1) to (15) unless defined otherwise elsewhere:</p> <p>(1) “Anchor handling winch” is any winch used for the purpose of deploying, recovering and repositioning anchors and mooring lines in subsea operations.</p> <p>(2) “Loose gear” is wires, chains, rings, hooks, shackles, swivels, clamps, etc. which are removable parts used</p>		<p>The actual delivery date is the date of delivery of the lifting appliances to the shipyard (when the ship is under construction) or the ship (when the ship is in operation). SOLAS II-1/3-13.3</p> <p>For non-SOLAS ships</p> <p>SOLAS II-1/2.31 “Anchor handling winch”</p> <p>SOLAS II-1/2.32 “Loose gear”</p>

Amended-Original Requirements Comparison Table (Lifting Appliances and Anchor Handling Winches)

Amended	Original	Remarks
<p><u>for transmitting loads to structural members but which do not form an integral part of anchor handling winches and loads.</u></p> <p>(3) <u>“Brake holding force” is the maximum force for which the winch brake is designed.</u></p> <p>(4) <u>“Brake holding capacity” is the maximum line pull that the winch brake can withstand without slipping of the brake.</u></p> <p>(5) <u>“Maximum line pull” is the maximum sustained force the winch is capable of pulling.</u></p> <p>(6) <u>“Static bollard pull” is the maximum sustained pulling force a ship is capable of generating at maximum power (i.e. 100 % maximum continuous rating (MCR)) and zero forward speed.</u></p> <p>(7) <u>“Wire” is a dedicated line (wire rope, synthetic rope or chain cable) used for the handling of anchors by means of an anchor handling winch. Wires may include connecting loose gear.</u></p> <p>(8) <u>“Chain stopper” is a device used for securing and holding a part of a wire, thereby relieving the load on the winch drum.</u></p> <p>(9) <u>“Competent person” is a person possessing the knowledge and experience required for the performance of duties specified in this Part 2 and acceptable as such to the Administration.</u></p> <p>(10) <u>“Inspection” is an assessment carried out by a responsible person to ascertain if the anchor handling winches or associated loose gear are in good working condition for continued safe use.</u></p> <p>(11) <u>“Responsible person” is a person appointed by the master or company as defined in regulation IX/I of SOLAS, as appropriate, possessing the knowledge and experience required for the performance of duties</u></p>		<p>MSC.1/Circ.1662 Para2.1 “Brake holding force” Para2.2 “Brake holding capacity” Para2.3 “Maximum line pull” Para2.4 “Static bollard pull” Para2.5 “A wire” Para2.6 “Chain stopper” Para2.7 “Competent person” Para2.8 “Inspection” Para2.9 “Responsible person”</p>

Amended-Original Requirements Comparison Table (Lifting Appliances and Anchor Handling Winches)

Amended	Original	Remarks
<p><u>specified in this Part 2.</u></p> <p>(12) <u>“Thorough examination” is a detailed assessment carried out by a competent person in order to determine whether anchor handling winches or associated loose gear are in compliance with applicable requirements of the Administration.</u></p> <p>(13) <u>“Maintenance” is any activity carried out by a responsible person to keep the anchor handling winches or associated loose gear in good working condition for continued safe use.</u></p> <p>(14) <u>“Operational testing” is a test carried out by a responsible person to verify the correct functioning of a component or operation of the anchor handling winches or associated loose gear.</u></p> <p>(15) <u>“Load test” is a test in excess of the maximum line pull, carried out in the presence of a competent person in order to check the structural integrity and adequacy of anchor handling winches, their attachments and their supporting structures.</u></p> <p>(16) <u>“Proof” test is load test of loose gear as specified in (15), carried out by manufacturer without a surveyor in attendance.</u></p> <p><u>1.3 Arrangement, Construction and Materials</u></p> <p><u>1.3.1 Arrangement</u></p> <p><u>Anchor handling winches are to have completely clear after decks in order to effectively handle anchors.</u></p>		<p>Para2.10 “Thorough examination”</p> <p>Para2.12 “Maintenance”</p> <p>Para2.13 “Operational testing”</p> <p>Para2.14 “Load test”</p> <p>Refer to Para.3 of Part 1</p> <p>8.3.3-1, Part O of the Rules</p>

Amended-Original Requirements Comparison Table (Lifting Appliances and Anchor Handling Winches)

Amended	Original	Remarks
<p>1.3.2 Construction</p> <p>1 <u>The supporting structures of anchor handling winches are to be such to ensure sufficient strength and the allowable stress values for each member of the supporting structures of anchor handling winches are, in principle, to be as given below. Different values, however, may be used in consideration of the arrangements, etc. of the supporting structures.</u></p> <p>$\sigma = 166/K(N/mm^2)$ $\tau = 96/K(N/mm^2)$ $\sigma_e = 196/K(N/mm^2)$</p> <p>σ: $\sigma_a + \sigma_b$ (Normal stress) σ_a: Axial stress σ_b: Bending stress τ: Shearing stress in plane σ_e: $\sigma_e = \sqrt{\sigma^2 + 3\tau^2}$ (Equivalent stress) K: Coefficient corresponding to the kind of steel <u>e.g. 1.0 for mild steel, the values specified in 3.2.1.2-2, Part 1, Part C of the Rules for the Survey and Construction of Steel Ships for high tensile steel</u></p> <p>2 <u>The design loads for the supporting structures of anchor handling winches are not to be less than the breaking strength of the anchor handling winches, the maximum braking capacity of the winch, or the maximum hoisting capacity of the winch, whichever is the greatest.</u></p> <p>3 <u>In cases where anchor handling operations are conducted using after deck stern rollers, the aft terminals in way of the stern areas for anchor handling are to be round in shape.</u></p>		<p>8.3.2-1, Part O of the Rules O8.3.2, Part O of the Guidance</p> <p>8.3.2-2, Part O of the Rules</p> <p>8.3.3-2, Part O of the Rules</p>

Amended-Original Requirements Comparison Table (Lifting Appliances and Anchor Handling Winches)

Amended	Original	Remarks
<p><u>1.3.3 Materials*</u></p> <p><u>1 For the anchor handling winched always used in especially cold zones, the Society may require the use of steel materials of higher notch toughness.</u></p> <p><u>2 The materials of bolts and nuts used for connection of components of the structural members are to be considered appropriate by the Society.</u></p> <p><u>3 Wire ropes used as components of the structural members are to be those specified in Part L of the Rules for the Survey and Construction of Steel Ships or of an equivalent quality.</u></p> <p><u>4 The materials used in the main parts of the installations of driving systems are to comply with the standards in Part K of the Rules for the Survey and Construction of Steel Ships or any standards recognized by the Society to be of equivalent qualities.</u></p> <p align="center"><u>Chapter 2 SURVEYS</u></p> <p><u>2.1 General</u></p> <p><u>2.1.1 Application</u></p> <p><u>1 This chapter applies to the tests and surveys for the anchor handling winches and loose gear.</u></p> <p><u>2 Where the structural members of the anchor handling winches are permanently fitted to the hull structure or where they form an integral part thereof, the tests and surveys for these parts are to comply with this chapter in addition to relevant requirements in the Rules for the Survey and</u></p>		<p>Refer to Para.1.3.4 of Part 1</p>

Amended-Original Requirements Comparison Table (Lifting Appliances and Anchor Handling Winches)

Amended	Original	Remarks
<p><u>Construction of Steel Ships.</u></p> <p><u>3</u> At periodical surveys, a Society surveyor (hereinafter referred to as “surveyor”) may require items other than those specified in 2.2 through 2.5 in this chapter be surveyed where deemed necessary.</p> <p><u>2.1.2 Preparation for Surveys and Others</u></p> <p><u>1</u> All preparations required for surveys as well as that which may be required by surveyors as necessary in accordance with this Part 2 are to be made by survey applicants. Such preparations are to include provisions for easy and safe access, necessary facilities and necessary records for the execution of the survey. Inspection, measuring and test equipment, which surveyors rely on to make decisions affecting classification are to be individually identified and calibrated to a standard deemed appropriate by the Society. However, surveyors may use simple measuring equipment provided by the ship (rulers, measuring tapes, weld gauges, micrometers, etc.) without individual identification or confirmation of calibration, on the condition that it is of standard commercial design, properly maintained and periodically compared with other similar equipment or test pieces. Surveyors may also use other equipment (pressure, temperature or rpm gauges and meters, etc.) provided by the ship for the examination of onboard equipment when deemed appropriate based either on calibration records or comparison of readings with multiple instruments.</p> <p><u>2</u> Survey applicants are to arrange supervisors who are well conversant with the survey items needing preparation and capable of providing necessary assistance to surveyors according to their requests during surveys.</p>		

Amended-Original Requirements Comparison Table (Lifting Appliances and Anchor Handling Winches)

Amended	Original	Remarks
<p><u>3 Surveys may be suspended where necessary preparations have not been made, the appropriate attendant mentioned in the -2 above is not present, or the surveyor considers that the safe execution of the survey is not ensured.</u></p> <p><u>4 Where repairs are deemed necessary as a result of the survey, surveyors will notify survey applicants of their recommendations. Upon such notification, repairs are to be made to the satisfaction of the surveyor.</u></p> <p><u>5 In cases where it is necessary to replace any fittings, equipment, parts, etc. used on board, replacements are to comply with the requirements applied during ship construction. However, in cases where new requirements are specified or where deemed necessary by the Society, the Society may require that such replacements comply with any new requirements in effect at the time the relevant replacement work is carried out. In addition, replacements are not to use any materials which contain asbestos.</u></p> <p><u>2.1.3 Notification of Survey Results</u></p> <p><u>1 Surveyors are to notify survey applicants of the results of surveys in the form of a Survey Record.</u></p> <p><u>2 In case where repairs are requested by the attending surveyor, said repairs are to be made to the satisfaction of the surveyor.</u></p> <p><u>2.1.4 Out of Service Anchor Handling Winches and Loose Gear</u></p> <p><u>If on completion of a thorough examination, the competent person considers the anchor handling winches and loose gear to be unsafe for operation or not in compliance with the applicable requirements of the Administration, that anchor handling winches and loose gear are to be taken out of service</u></p>		<p>MSC.1/Circ.1662 Para3.3.4, 4.7.1.2</p> <p>MSC.1/Circ.1662 Para.3.2.3.2, 4.2.2.2</p>

Amended-Original Requirements Comparison Table (Lifting Appliances and Anchor Handling Winches)

Amended	Original	Remarks
<p><u>until any deficiency is rectified to the satisfaction of a competent person. The anchor handling winches and loose gear are to be clearly marked “not to be used” and the status is to be recorded in the Survey Record. While out of service, 2.1.5 is to be followed.</u></p> <p><u>2.1.5 Inoperative Anchor Handling Winches, Associated Equipment and Loose Gear</u></p> <p><u>The following actions are to be taken by the master to mitigate risks posed by inoperative anchor handling winches, associated equipment and loose gear:</u></p> <ol style="list-style-type: none"> <u>(1) Take the inoperative anchor handling winches, associated equipment and wire into account in the planning and executing of a safe voyage;</u> <u>(2) Prevent operation of inoperative anchor handling winches, associated equipment and loose gear;</u> <u>(3) Prevent uncontrolled movement of inoperative anchor handling winches, associated equipment and loose gear using appropriate restraining and preventing arrangements, if required;</u> <u>(4) Store inoperative loose gear separately from in-service loose gear and mark it as being inoperative;</u> <u>(5) Record the particulars of anchor handling winches, associated equipment and loose gear that are inoperative until necessary repairs have been completed and they have been tested or proof tested, as necessary, and thoroughly examined.</u> 		<p>MSC.1/Circ.1662 Para.5</p>

Amended-Original Requirements Comparison Table (Lifting Appliances and Anchor Handling Winches)

Amended	Original	Remarks
<p><u>2.2 Kinds of Surveys and Timing of Surveys</u></p> <p><u>2.2.1 Kinds of Surveys</u> <u>The kinds of Surveys for anchor handling winches and loose gear are as follows:</u></p> <p>(1) <u>Surveys for registration (hereinafter referred to as “Registration Survey”)</u></p> <p> (a) <u>Registration Surveys during Construction</u></p> <p> (b) <u>Registration Surveys of Anchor Handling Winches not built under Survey</u></p> <p>(2) <u>Periodical Surveys for maintaining registration</u></p> <p> (a) <u>Thorough Examinations</u></p> <p> (b) <u>Periodical Tests</u></p> <p> (c) <u>Occasional Surveys</u></p> <p> (d) <u>Unscheduled Surveys</u></p> <p><u>2.2.2 Timing of Surveys</u> <u>The timing of the Surveys for anchor handling winches and loose gear is to be in accordance with the following:</u></p> <p>(1) <u>A Registration Survey is to be carried out when the anchor handling winches are assigned for the first time.</u></p> <p>(2) <u>Thorough examinations are to be carried out at the following (a) through (d) times.</u></p> <p> (a) <u>At Registration Surveys</u></p> <p> (b) <u>At Annual Surveys, Intermediate Surveys and Renewal Surveys</u></p> <p> (c) <u>At Occasional Surveys when deemed necessary by the Society</u></p> <p> (d) <u>After load tests (including after proof tests)</u></p> <p>(3) <u>Periodical tests are to be carried out at the following (a) through (c) times.</u></p>		<p>MSC.1/Circ.1662 Para.3.2.3.1, 4.2.2.1</p>

Amended-Original Requirements Comparison Table (Lifting Appliances and Anchor Handling Winches)

Amended	Original	Remarks
<p><u>(a) At Annual Surveys and Intermediate Surveys. However, in cases where the operation test records are maintained appropriately and a Society’s surveyor considers it acceptable, the periodical test may be the confirmation of the test records at the times of such surveys.</u></p> <p><u>(b) At Renewal Surveys</u></p> <p><u>(4) An Occasional Survey is to be carried out when the anchor handling winches and loose gear fall under any of the following conditions at a time other than a Registration Survey, thorough examinations, periodical test or unscheduled survey. To implement the survey, in lieu of the traditional ordinary surveys where a surveyor is in attendance, the Society may approve survey methods which it considers to be appropriate.</u></p> <p><u>(a) When serious damage is caused on the structural members and the repair or conversion is made</u></p> <p><u>(b) When major conversion is made in the anchor handling procedures, wire arrangements, operation and control methods</u></p> <p><u>(c) When the assignment and marking of safe working load, etc. is altered</u></p> <p><u>(d) Other cases when considered necessary by the Society</u></p> <p><u>(5) The classed ships may be subject to unscheduled surveys when the confirmation of the status of appliances by survey is deemed necessary in cases where the Society considers the appliances to be subject to 1.4-3, Conditions of Service for Classification of Ships and Registration of Installations. At unscheduled surveys, investigations, examinations or tests are to be made to the satisfaction</u></p>		

Amended-Original Requirements Comparison Table (Lifting Appliances and Anchor Handling Winches)

Amended	Original	Remarks
<p><u>of surveyors with respect to the matters concerned.</u></p> <p><u>2.2.3 Through Examinations and Periodical Tests Carried Out in Advance</u></p> <p><u>Through examinations and periodical tests may be carried out in advance of the due date of each survey upon application by shipowners.</u></p> <p><u>2.2.4 Postponement of Through Examinations and Periodical Tests *</u></p> <p><u>Thorough examinations and periodical tests may be postponed from the date specified in 2.2.2 subject to approval by the Society.</u></p> <p><u>2.3 Registration Surveys</u></p> <p><u>2.3.1 Drawings and Other Documents to be Submitted*</u></p> <p><u>1 At Registration Surveys, it is to be verified that the strength and construction of anchor handling winches and loose gear comply with the Rules based on the drawings and documents submitted to the Society. In such cases, survey applicants are to submit an application form in addition to the relevant drawings and documents listed in the following -2, -3 and -4.</u></p> <p><u>2 The drawings and documents listed in the following (1) through (11) are to be submitted for approval for anchor handling winches and loose gear to be newly constructed:</u></p> <p><u>(1) General arrangement of anchor handling winches</u></p>		<p>Same as Part 1</p>

Amended-Original Requirements Comparison Table (Lifting Appliances and Anchor Handling Winches)

Amended	Original	Remarks
<p>(2) <u>Construction drawings of anchor handling winches (including the dimensions of structural members, specifications of materials and joint details)</u></p> <p>(3) <u>Drawings of fittings (including the dimensions, specifications of materials and the fixing methods of these fittings with structural members or hull structure)</u></p> <p>(4) <u>Arrangement of loose gear (including wire arrangement)</u></p> <p>(5) <u>List of loose gear (Showing the construction, dimensions, materials and locations. For those in compliance with a well-known code or standard, a type symbol may be used in place of dimensions and materials)</u></p> <p>(6) <u>Construction drawings of driving gears</u></p> <p>(7) <u>Power system diagram</u></p> <p>(8) <u>Drawings of operation and control mechanisms</u></p> <p>(9) <u>Drawings of safety devices</u></p> <p>(10) <u>Drawings of protective devices</u></p> <p>(11) <u>Other drawings and documents as deemed necessary by the Society</u></p> <p>3 <u>The drawings and documents listed in the following (1) through (6) are to be submitted for reference for anchor handling winches and loose gear to be newly constructed:</u></p> <p>(1) <u>Specifications for anchor handling winches</u></p> <p>(2) <u>Calculation sheets or check sheets relevant to drawings and documents for approval specified in -2 above</u></p> <p>(3) <u>Operation and maintenance manuals for anchor handling winches</u></p> <p>(4) <u>Procedures for commissioning tests</u></p> <p>(5) <u>Asbestos-free declarations and supporting documents</u></p> <p>(6) <u>Other drawings and documents as deemed necessary</u></p>		

Amended-Original Requirements Comparison Table (Lifting Appliances and Anchor Handling Winches)

Amended	Original	Remarks
<p><u>by the Society</u></p> <p><u>4 At Registration Surveys of anchor handling winches installed on or after 1 January 2026 and loose gear not built under survey, the drawings and data to be submitted for the anchor handling winch and loose gear are the same as specified in -2 and -3 above. However, some of these drawings and documents may be omitted in lieu of submitting relevant past survey records and certificates subject to Society approval.</u></p> <p><u>2.3.2 Surveys*</u></p> <p><u>1 Workmanship of anchor handling winches and loose gear is to be examined and ascertained to be in good order when any of the following (1) through (5) is relevant:</u></p> <p><u>(1) During the manufacturing process or during structural member assembly when requested by the Society.</u></p> <p><u>(2) When structural members are installed on board the ship</u></p> <p><u>(3) For driving gears, at times when the finishing work on major parts is completed and when the surveyor considers necessary during the manufacturing process</u></p> <p><u>(4) When subcontracted materials, parts or equipment are incorporated into anchor handling winches or loose gear</u></p> <p><u>(5) Other cases when considered necessary by the Society</u></p> <p><u>2 Anchor handling winches and loose gear are to be examined and ascertained to be in good order by the following tests and surveys:</u></p> <p><u>(1) The tests specified in Part K of the Rules for the Survey and Construction of Steel Ships when the materials used need to comply with Part K.</u></p> <p><u>(2) The test specified in Part M of the Rules for the Survey and Construction of Steel Ships when</u></p>		

Amended-Original Requirements Comparison Table (Lifting Appliances and Anchor Handling Winches)

Amended	Original	Remarks
<p>welding work needs to be comply with Part M.</p> <p>(3) <u>Non-destructive testing when requested by surveyors</u></p> <p>(4) <u>Shop trials of driving gears</u></p> <p>(5) <u>Operation tests of safety devices and protective devices (including braking tests and electric power source cut-off tests). Said tests may be performed during the commissioning tests described in the following (6).</u></p> <p>(6) <u>Commissioning tests (after installation on board)</u></p> <p>(7) <u>Thorough examinations (according to 2.4)</u></p> <p>(8) <u>Other tests considered necessary by the Society</u></p> <p>3 <u>To implement the tests and surveys specified in -1 and -2 above (hereinafter referred to as “survey” in this subparagraph) in lieu of traditional ordinary surveys where a surveyor is in attendance, the Society may approve other survey methods which it considers to be appropriate.</u></p> <p>2.3.3 Commissioning Tests</p> <p>1 <u>Commissioning tests for anchor handling winches are to be carried out according to manufacturer instructions or applicable national or international standards acceptable to the Administration and which provide an equivalent level of safety. Commissioning tests are to include the following:</u></p> <p>(1) <u>Function tests at light loads to verify the correct working of winches and their controls over their full operating range.</u></p> <p>(2) <u>Overload tests to verify the capacity and integrity of winches, the attachments of winches to ships and the adequacy of ship supporting structures.</u></p> <p>(3) <u>Tests of emergency release and residual holding force in wires. Said tests are to be performed with wires attached to onshore strong points, or anchors on the seabed or similar arrangements. The residual brake</u></p>		<p>MSC.1/Circ.1662 Para 3.2.1 MSC.1/Circ.1662 Para 3.2.1.1</p>

Amended-Original Requirements Comparison Table (Lifting Appliances and Anchor Handling Winches)

Amended	Original	Remarks
<p><u>holding force after emergency release is to be verified by testing.</u></p> <p><u>(4) Function tests of whole winch systems, including static bollard pull tests and brake holding capacity tests. Where it is not practicable to verify the brake holding capacity by testing, the same may be demonstrated through calculations.</u></p> <p><u>2 After major repairs, modifications or alterations, anchor handling winches are to be tested in accordance with -1(1), (2) and (4) above. In cases where the emergency release system is affected by said major repairs, modifications or alterations, anchor handling winches are to be additionally tested in accordance with -1(3) above.</u></p> <p><u>3 Major repairs, modifications or alterations are those of the following (1) to (4):</u></p> <p><u>(1) Changes in the rated wire pull of anchor handling winches</u></p> <p><u>(2) Changes that affect the strength, stability or service life of anchor handling winches</u></p> <p><u>(3) Changes that affect the primary load bearing structures of anchor handling winches</u></p> <p><u>(4) Modifications to the functionality of anchor handling winches or any part thereof which may affect winch strength, safety or structural integrity</u></p> <p><u>4 Anchor handling winches not designed for towing do not need to undergo the bollard pull tests in -1(4) above. Functional tests other than static bollard pull tests, however, are still required.</u></p>		<p>MSC.1/Circ.1662 Para 3.2.1.2</p> <p>MSC.1/Circ.1662 Para 3.2.1.3</p> <p>MSC.1/Circ.1662 Para 3.2.1.4 Static bollard pull test can be omitted when towing is not performed.</p>

Amended-Original Requirements Comparison Table (Lifting Appliances and Anchor Handling Winches)

Amended	Original	Remarks
<p><u>2.3.4 Proof Tests</u></p> <p><u>1 All loose gear in use with anchor handling winches and associated equipment is to have documentary evidence of a proof test before being put into use for the first time, and be retested after major repairs, modifications or alterations.</u></p> <p><u>2 The loose gear in -1 above is to be retested after major repairs, modifications or alterations.</u></p> <p><u>2.4 Thorough Examinations</u></p> <p><u>2.4.1 Anchor Handling Winches</u></p> <p><u>At thorough examinations, the following items in (1) are to be visually examined for cranes and ascertained to be in good order. Where considered necessary by surveyors, the items in (2) are also to be examined.</u></p> <p><u>(1) Items to be examined</u></p> <ul style="list-style-type: none"> <u>(a) Structural members</u> <u>(b) Connections between structural members and hull structures</u> <u>(c) Installations of driving system</u> <u>(d) Safety devices and protective devices</u> <u>(e) Markings for maximum brake holding capacity, maximum line pull, etc., and the validity of relevant certificates</u> <u>(f) Provision of operation and maintenance manuals on board the ship</u> <p><u>(2) Items to be examined where considered necessary by surveyors</u></p> <ul style="list-style-type: none"> <u>(a) Checking of plate thickness of structural members, non-destructive testing and open-up</u> 		<p>MSC.1/Circ.1662 Para4.2.1 MSC.1/Circ.1662 Para4.2.1</p> <p>Same above</p> <p>MSC.1/Circ.1662 Para 3.2.3</p>

Amended-Original Requirements Comparison Table (Lifting Appliances and Anchor Handling Winches)

Amended	Original	Remarks
<p><u>examinations of bearings</u></p> <p><u>(b) Open-up examinations of driving gears</u></p> <p><u>(c) Operation tests of safety devices and protective devices</u></p> <p><u>2.4.2 Loose Gear</u></p> <p><u>At thorough examinations, the following (1) to (3) for loose gear are to be visually examined and verified to be in good order. However, where considered necessary by the surveyor, the items in (2) are to be opened up and examined.</u></p> <p><u>(1) Wires throughout their full length</u></p> <p><u>(2) Chains, rings, hooks, shackles, swivels, cramps, etc.</u></p> <p><u>(3) Safe working load and identification symbol markings, and the validity of the relevant certificates</u></p> <p><u>2.5 Periodical Tests</u></p> <p><u>2.5.1 General</u></p> <p><u>1 Anchor handling winches and associated equipment are to be operationally and functionally tested according to the manufacturer recommendations.</u></p> <p><u>2 Operation tests of safety devices and protective devices (including braking tests and electric power source cut-off tests) are to be included in periodical tests.</u></p>		<p>Same as 2.4.5 of Part 1</p> <p>MSC.1/Circ.1662 Para 4.2.2.1</p> <p>MSC.1/Circ.1662 Para 3.2.2</p> <p>MSC.1/Circ.1662 Para 3.2.2</p>

Amended-Original Requirements Comparison Table (Lifting Appliances and Anchor Handling Winches)

Amended	Original	Remarks
<p><u>2.6 Records of Thorough Examination and Testing</u></p> <p><u>2.6.1 Anchor Handling Winches</u> <u>Records of thorough examinations and tests are to be maintained in the Survey Record and are to be available on board.</u></p> <p><u>2.6.2 Loose Gear</u> <u>Records of thorough examinations and proof tests are to be maintained in the Survey Record and are to be available on board.</u></p> <p><u>Chapter 3 DESIGN, CONSTRUCTION AND INSTALLATION</u></p> <p><u>3.1 General</u></p> <p><u>3.1.1 Application</u> <u>1 This chapter applies to anchor handling winches, associated equipment and loose gear.</u> <u>2 Anchor handling winches, associated equipment and loose gear are to be designed, constructed and installed in accordance with standards acceptable to the Administration which provide an equivalent level of safety.</u></p>		<p>MSC.1/Circ.1662 Para.3.2.4, Para.4.7.1</p> <p>MSC.1/Circ.1662 Para.4.7.1.1</p> <p>MSC.1/Circ.1662 Para.3.1</p> <p>MSC.1/Circ.1662 Para.3.1.1</p>

Amended-Original Requirements Comparison Table (Lifting Appliances and Anchor Handling Winches)

Amended	Original	Remarks
<p><u>3.2 Anchor Handling Winches</u></p> <p><u>3.2.1 Speed Control and Handling</u></p> <p><u>1 Anchor handling winches are to be capable of hoisting and lowering in a controlled manner and are to be provided with adjustable speed control between the minimum and maximum speeds.</u></p> <p><u>2 Winch operating controls are to be designed to pay out wires by moving control levers away from winch operators and heave in by pulling control levers towards operators. All operating controls are to be permanently marked with signs indicating their purpose and operating direction.</u></p> <p><u>3 Winch operating controls are to be of the “hold-to run” type, which will cause the hoisting or lowering motion to automatically stop when the control lever is released by the operator.</u></p> <p><u>3.2.2 Tension Control</u></p> <p><u>1 Anchor handling winches are to be equipped with tension control to ensure that systems are not overloaded in the event that the anchor being handled gets stuck, entangled or is otherwise exposed to similar situations.</u></p> <p><u>2 Means are to be provided for measuring the tension of the anchor handling and tow lines specified in -1 above for display at control stations.</u></p> <p><u>3.2.3 Overload Alarms and Monitoring</u></p> <p><u>1 Winches are to be provided with continuous load monitors and audible and visual overload alarms.</u></p> <p><u>2 Overload alarms are to be programmable for lower levels of loads.</u></p>		<p>MSC.1/Circ.1662 Para.3</p> <p>MSC.1/Circ.1662 Para.3.1.2</p> <p>MSC.1/Circ.1662 Para.3.1.2.1</p> <p>MSC.1/Circ.1662 Para.3.1.2.2</p> <p>MSC.1/Circ.1662 Para.3.1.2.3</p> <p>MSC.1/Circ.1662 Para.3.1.3</p> <p>MSC.1/Circ.1662 Para.3.1.3</p> <p>8.5.2-3, Part O of the Rules</p> <p>MSC.1/Circ.1662 Para.3.1.4</p> <p>MSC.1/Circ.1662 Para.3.1.4.1</p> <p>MSC.1/Circ.1662 Para.3.1.4.2</p>

Amended-Original Requirements Comparison Table (Lifting Appliances and Anchor Handling Winches)

Amended	Original	Remarks
<p><u>3.2.4 Control Stations</u></p> <p><u>1 Main control stations are to be placed at positions on the bridge which have clear views of the deck area. Operators are to be able to visually monitor anchor handling winches and associated equipment and, if the view is obstructed, cameras or video monitoring devices may be used for this purpose.</u></p> <p><u>2 Anchor handling winches may be controlled from more than one position provided that arrangements to prevent more than one position from exercising control at any one time are provided.</u></p> <p><u>3 Each control station is to be provided with following (1) through (4).</u></p> <p><u>(1) Means for two-way communication with the main control station;</u></p> <p><u>(2) Arrangements to prevent inadvertent actuation</u></p> <p><u>(3) Adequate protection of personnel;</u></p> <p><u>(4) Sufficient illumination with a minimum lighting level of at least 320 Lux</u></p> <p><u>3.2.5 Spooling Devices</u></p> <p><u>Anchor handling winches are to be equipped with remotely operated spooling devices.</u></p> <p><u>3.2.6 Emergency Release</u></p> <p><u>1 Anchor handling winches are to be designed to facilitate emergency release of loads on wires in a safe and controlled manner, both under normal and dead-ship conditions.</u></p> <p><u>2 Emergency release actuation controls are to be placed at main control stations. Emergency release functions may also be available at local control stations.</u></p> <p><u>3 Emergency release controls are to be protected against</u></p>		<p>MSC.1/Circ.1662 Para.3.1.5 MSC.1/Circ.1662 Para.3.1.5.1</p> <p>MSC.1/Circ.1662 Para.3.1.5.2</p> <p>MSC.1/Circ.1662 Para.3.1.5.3</p> <p>MSC.1/Circ.1662 Para.3.1.6 MSC.1/Circ.1662 Para.3.1.6 MSC.1/Circ.1662 Para.3.1.7 MSC.1/Circ.1662 Para.3.1.7.1</p> <p>MSC.1/Circ.1662 Para.3.1.7.2</p> <p>MSC.1/Circ.1662</p>

Amended-Original Requirements Comparison Table (Lifting Appliances and Anchor Handling Winches)

Amended	Original	Remarks
<p><u>unintentional activation.</u></p> <p><u>4</u> Emergency release design and operation are to take into consideration restrictions on the pay-out speeds of wires due to inertia and any restrictions due to onboard arrangements.</p> <p><u>5</u> Instructions for emergency release operation are to be clearly displayed at navigations bridge and locally at winches.</p> <p><u>6</u> After an emergency release, the complete anchor handling winch system is to be inspected for signs of damage or deterioration. Any identified damage or deterioration is to be rectified before the anchor handling winch is put back into service.</p> <p><u>3.2.7 Chain Stoppers</u></p> <p><u>1</u> Anchor handling vessels are to be equipped with chain or wire stoppers (hereafter referred to as chain stoppers).</p> <p><u>2</u> Chain stoppers are to be equipped with audible alarms which activate when stoppers are either being engaged or disengaged.</p> <p><u>3</u> Chain stoppers are to be equipped with an emergency release that is functional in all conditions, including dead-ship situations.</p> <p><u>4</u> Emergency release of chain stoppers is to include the disengaging of pins and other equipment that may prevent the releasing of wires or cause wires to get stuck or entangled during release.</p> <p><u>5</u> Emergency release of chain stoppers is to be designed for remote operation in order to minimize the risk of injury to personnel.</p> <p><u>6</u> Emergency release mechanisms of chain stoppers are to be protected against unintentional activation.</p>		<p>Para.3.1.7.3 MSC.1/Circ.1662 Para.3.1.7.4</p> <p>MSC.1/Circ.1662 Para.3.1.7.5</p> <p>MSC.1/Circ.1662 Para.3.1.7.6</p> <p>MSC.1/Circ.1662 Para.3.1.8.1 MSC.1/Circ.1662 Para.3.1.8.1.1</p> <p>MSC.1/Circ.1662 Para.3.1.8.1.2</p> <p>MSC.1/Circ.1662 Para.3.1.8.1.3</p> <p>MSC.1/Circ.1662 Para.3.1.8.1.4</p> <p>MSC.1/Circ.1662 Para.3.1.8.1.5</p> <p>MSC.1/Circ.1662 Para.3.1.8.1.6</p>

Amended-Original Requirements Comparison Table (Lifting Appliances and Anchor Handling Winches)

Amended	Original	Remarks
<p><u>7 Instructions for emergency release operation are to be clearly displayed at navigation bridges and locally at emergency release control mechanisms.</u></p> <p><u>8 After an emergency release, the chain stopper system is to be inspected for signs of damage or deterioration. Any identified damage or deterioration is to be rectified before the chain stopper is put back into service.</u></p> <p><u>3.2.8 Winch Brakes</u> Each anchor handling winch is to be provided with a means of power control braking. Such as means is to be regenerative, dynamic, counter torque breaking, controlled lowering or mechanically controlled braking which is capable of maintaining control at low speeds. Brakes are to be applied automatically upon loss of power or whenever winch levers are returned to the neutral position.</p> <p><u>3.2.9 Power Supply</u> <u>When the power supply for normal operation of an anchor handling winch is the same as the power supply for propulsion equipment, such as shaft generators, shaft power take-offs (PTO), etc., an independent (redundant) power supply with sufficient capacity for winch operation is to be available to ensure that ship manoeuvrability during anchor handling operations is not degraded.</u></p> <p><u>3.3 Loose Gear</u></p> <p><u>3.3.1 General</u> <u>Loose gear used for anchor handling winches is to be designed and manufactured according to Chapter 6 of Part 1.</u></p>		<p>MSC.1/Circ.1662 Para.3.1.8.1.7</p> <p>MSC.1/Circ.1662 Para.3.1.8.1.8</p> <p>8.5.3, Part O of the Rules</p> <p>8.5.4, Part O of the Rules</p> <p>MSC.1/Circ.1662 Para.4</p> <p>MSC.1/Circ.1662 Para 4.1</p>

Amended-Original Requirements Comparison Table (Lifting Appliances and Anchor Handling Winches)

Amended	Original	Remarks
<p><u>3.4 Markings</u></p> <p><u>3.4.1 Nameplates</u></p> <p><u>1 Anchor handling winches are to be provided with a permanently affixed name plate which includes at least the following (1) through (12) information.</u></p> <p><u>(1) Manufacturer details (name and address)</u></p> <p><u>(2) Model name or number</u></p> <p><u>(3) Serial number</u></p> <p><u>(4) Date of manufacture and date of installation</u></p> <p><u>(5) Power supply details of power supply</u></p> <p><u>(6) Wire details of wire (e.g. length and diameter)</u></p> <p><u>(7) Maximum brake holding capacity in metric tons</u></p> <p><u>(8) Maximum line pull in metric tons</u></p> <p><u>(9) Maximum static bollard pull in metric tons</u></p> <p><u>(10) Placeholders for Society surveyor stamps</u></p> <p><u>(11) Drum size;</u></p> <p><u>(12) Winch speed</u></p> <p><u>2 Detailed specifications of anchor handling winches, such as -1(4) thorough (12), can be included in other documentation (e.g. in the anchor handling winch operation and maintenance manuals provided on board).</u></p> <p><u>3 It is to be ensured that documentation on board can be unambiguously related to the actual winch (e.g. by referring to the unique serial number for a winch).</u></p> <p><u>4 Loose gear is to be clearly and permanently marked with its unique identification (serial no.), safe working load (SWL) and any additional marks required for safe use.</u></p> <p><u>5 In -4 above, in cases where there is insufficient space for markings on loose gear other than the SWL, the omitted information is to be included in the certificate or be provided</u></p>		<p>MSC.1/Circ.1662 Para 4.4 MSC.1/Circ.1662 Para 3.4 MSC.1/Circ.1662 Para 3.4.1</p> <p>MSC.1/Circ.1662 Para 3.4.2</p> <p>MSC.1/Circ.1662 Para 3.4.3</p> <p>MSC.1/Circ.1662 Para 4.4.1</p> <p>MSC.1/Circ.1662 Para 4.4.2</p>

Amended-Original Requirements Comparison Table (Lifting Appliances and Anchor Handling Winches)

Amended	Original	Remarks
<p><u>by other suitable means.</u></p> <p><u>Chapter 4 OPERATIONS, MAINTENANCE, INSPECTION AND OPERATIONAL TESTING</u></p> <p><u>4.1 General</u></p> <p><u>4.1.1 General</u> <u>This chapter describes the matters to be observed by the ship owners or ship operators responsible for ships.</u></p> <p><u>4.2 Anchor Handling Winches</u></p> <p><u>4.2.1 Maintenance, Inspection and Operational Testing</u></p> <p><u>1 Maintenance, inspection, operational testing and their respective intervals are to be in accordance with manufacturer recommendations, industry standards and guidelines and recommendations acceptable to the Administration in consideration of factors such as the operational profile of the ship and the anchor handling winch.</u></p> <p><u>2 All anchor handling winches and associated equipment are to be considered vulnerable to marine environmental conditions which may lead to significant and accelerated deterioration and corrosion, and an inspection and maintenance regime is to be implemented accordingly.</u></p>		<p>MSC.1/Circ.1662 Para 3 MSC.1/Circ.1662 Para 3.5</p> <p>MSC.1/Circ.1662 Para 3.5.1.1</p> <p>MSC.1/Circ.1662 Para 3.5.1.2</p>

Amended-Original Requirements Comparison Table (Lifting Appliances and Anchor Handling Winches)

Amended	Original	Remarks
<p><u>3 The inspection and maintenance of anchor handling winches and associated equipment may involve working at heights, enclosed space entry and other hazards. These hazards are to be considered when developing the relevant procedures for undertaking such tasks, including safe access.</u></p> <p><u>4 Particular attention is to be paid to the following (1) thorough (6).</u></p> <p><u>(1) Corrosion and damage of primary structural members, such as winch frames and bedplates, drums, foundations and foundation connections, including welds and bolts</u></p> <p><u>(2) Wear, corrosion and damage of mechanical components including hydraulic or pneumatic cylinders, pins, winch drums, chain wheels, wire-spooling and guide systems, clutches, bearings, rollers, shafts, gears, bearings and brakes;</u></p> <p><u>(3) Correct setting and functioning of safety, protection and limiting devices</u></p> <p><u>(4) Condition and correct functioning of the anchor handling winch as a whole and, in particular, the piping and hoses, hydraulic arrangements, spooling devices, motors, and electrical and control systems</u></p> <p><u>(5) Corrosion and damage to all means of safe access to the anchor handling winch, including attached maintenance platforms and extensions, with particular attention paid to support brackets and welds</u></p> <p><u>(6) Certification and identification of all wires</u></p> <p><u>5 Damaged, broken, worn or corroded wires, including their terminations connecting loose gear, are to be inspected and discarded according to manufacturer recommendations, relevant industry standards or international standards.</u></p>		<p>MSC.1/Circ.1662 Para 3.5.1.3</p> <p>MSC.1/Circ.1662 Para 3.5.1.4</p> <p>MSC.1/Circ.1662 Para 3.5.1.5</p>

Amended-Original Requirements Comparison Table (Lifting Appliances and Anchor Handling Winches)

Amended	Original	Remarks
<p><u>6 In cases where upon the completion of an inspection, the responsible person considers the anchor handling winch to be unsafe for operation or not in compliance with the applicable requirements of the Administration, said anchor handling winch is to be taken out of service until any deficiency is rectified to the satisfaction of a competent person. The anchor handling winch is to be clearly marked “not to be used” and the status is to be recorded. While out of service, the relevant actions for inoperative anchor handling winches as outlined in 2.1.4 are to be followed.</u></p> <p><u>4.2.2 Maintenance Manuals</u></p> <p><u>1 The maintenance manual for an anchor handling winch is to be provided by its manufacturer. Where maintenance manuals for anchor handling winches installed before 1 January 2026 are not available from manufacturers, they are to be provided by competent third parties.</u></p> <p><u>2 The maintenance manual is, at a minimum, to include the following for each anchor handling winch.</u></p> <p><u>(1) Description of the required inspection regime and maintenance schedules specific to the anchor handling winch, checklists and a list of key tools or other items for use when carrying out inspections and maintenance</u></p> <p><u>(2) Instructions for routine repairs and maintenance</u></p> <p><u>(3) Technical maintenance information</u></p> <p><u>(4) Information on recommended lubricants, oil and filter change</u></p> <p><u>(5) Information on bearing maintenance, if applicable</u></p> <p><u>(6) Lists of replaceable parts and components and the inspection, maintenance and replacement procedures for said parts and components</u></p> <p><u>(7) Lists of sources of spare parts</u></p>		<p>MSC.1/Circ.1662 Para 3.5.1.6</p> <p>MSC.1/Circ.1662 Para 3.5.2 MSC.1/Circ.1662 Para 3.5.2.1</p> <p>MSC.1/Circ.1662 Para 3.5.2.2</p>

Amended-Original Requirements Comparison Table (Lifting Appliances and Anchor Handling Winches)

Amended	Original	Remarks
<p>(8) <u>Model forms for records of inspections and maintenance</u></p> <p>(9) <u>Operational test procedures and pre- and post-operational test inspection procedures</u></p> <p>(10) <u>List of components requiring particular attention during inspections and the inspection and maintenance procedures for said components</u></p> <p>(11) <u>Recommended intervals for replacement and overhaul of components and equipment</u></p> <p>(12) <u>Information on the preservation of coatings and corrosion protection systems</u></p> <p>(13) <u>Information regarding special inspections and maintenance in cases where the anchor handling winch is not operated for long periods of time</u></p> <p><u>4.2.3 Records of Inspections and Maintenance</u></p> <p><u>1</u> <u>Records of the routine inspections and maintenance of anchor handling winches or their components or parts are to be maintained and kept on board.</u></p> <p><u>2</u> <u>Records and particulars of inspection and maintenance may be documented in any convenient form, provided each entry contains the necessary information, is clearly legible and is authenticated by a responsible person. Manufacturer recommendations for said inspection and maintenance records are to be followed.</u></p> <p><u>4.2.4 Operations</u></p> <p><u>1</u> <u>Personnel operating anchor handling winches and their associated equipment are to be qualified, familiarized with the equipment and authorized by the master.</u></p>		<p>MSC.1/Circ.1662 Para 3.5.3 MSC.1/Circ.1662 Para 3.5.3.1</p> <p>MSC.1/Circ.1662 Para 3.5.3.2</p> <p>MSC.1/Circ.1662 Para 3.6 MSC.1/Circ.1662 Para 3.6.1.1</p>

Amended-Original Requirements Comparison Table (Lifting Appliances and Anchor Handling Winches)

Amended	Original	Remarks
<p><u>2 Personnel involved in anchor handling winch operations are to understand their roles during said operations and, in particular, the signals that may be required to commence, coordinate or stop the operation.</u></p> <p><u>3 Personnel involved in anchor handling winch operations are to be equipped with appropriate personal protective equipment for the task.</u></p> <p><u>4 Anchor handling winch operations are to be planned, supervised and carried out so that any identified risks are minimized.</u></p> <p><u>5 Procedures and instructions are to relate to the specific type of anchor handling winch and are to be included in the operations manual.</u></p> <p><u>6 Due consideration is to be given to any limiting operational conditions, such as ship's motions and inclination, environmental conditions including sea state, maximum wind speeds including wind gusts, ice and snow accretion, and limitations of the anchor handling winch, such as maximum line pull, maximum brake holding capacity, etc.</u></p> <p><u>7 Effective communication is to be established among ship personnel as well as with other ships or offshore units involved in the anchor handling winch operation.</u></p> <p><u>8 Safe means of access to anchor handling winches and the work area are to be established. Safe areas for the personnel involved are to be made available.</u></p> <p><u>9 When developing plans and procedures for anchor handling winch operations, consideration is to be given to prevention of accidents or incidents due to wires striking any person or other structures in close proximity.</u></p>		<p>MSC.1/Circ.1662 Para 3.6.1.2</p> <p>MSC.1/Circ.1662 Para 3.6.1.3</p> <p>MSC.1/Circ.1662 Para 3.6.1.4</p> <p>MSC.1/Circ.1662 Para 3.6.1.5</p> <p>MSC.1/Circ.1662 Para 3.6.1.6</p> <p>MSC.1/Circ.1662 Para 3.6.1.7</p> <p>MSC.1/Circ.1662 Para 3.6.1.8</p> <p>MSC.1/Circ.1662 Para 3.6.1.9</p>

Amended-Original Requirements Comparison Table (Lifting Appliances and Anchor Handling Winches)

Amended	Original	Remarks
<p><u>10 Procedures and measures for the safe operation of anchor handling winches are to take into account applicable international and national instruments and best practices for occupational safety and health.</u></p> <p><u>11 Personnel operating the anchor handling winch are to consult operations manuals for any specific instructions related to the anchor handling operations.</u></p> <p><u>12 Periodic drills for emergency release and emergency brake operation are to form part of the planned maintenance schedule.</u></p> <p><u>4.2.5 Operations Manuals</u></p> <p><u>1 The operations manuals for an anchor handling winch is to be provided by its manufacturer. Where operations manuals for anchor handling winches installed before 1 January 2026 are not available from manufacturers, they may be provided by competent third parties.</u></p> <p><u>2 The operations manual is, at a minimum, to include the following for each anchor handling winch:</u></p> <ul style="list-style-type: none"> <u>(1) Design, operational and environmental limitations</u> <u>(2) Compatible loose gear, if any</u> <u>(3) Safety instructions</u> <u>(4) Operating procedures, including emergency procedures, if any</u> <p><u>3 For anchor handling winches installed before 1 January 2026, operations manuals are to be developed with the original manufacture, design and build data, and take into account any modifications since installation. Where original data or modification data is not available, operations manuals are to be developed based on the current operational procedures and practices.</u></p>		<p>MSC.1/Circ.1662 Para 3.6.1.10</p> <p>MSC.1/Circ.1662 Para 3.6.1.11</p> <p>MSC.1/Circ.1662 Para 3.6.1.12</p> <p>MSC.1/Circ.1662 Para 3.6.2 MSC.1/Circ.1662 Para 3.6.2.1</p> <p>MSC.1/Circ.1662 Para 3.6.2.2</p> <p>MSC.1/Circ.1662 Para 3.6.2.3</p>

Amended-Original Requirements Comparison Table (Lifting Appliances and Anchor Handling Winches)

Amended	Original	Remarks
<p><u>4.3 Loose Gear</u></p> <p><u>4.3.1 Maintenance and Inspection</u></p> <p><u>1 Maintenance and inspections at respective intervals are to be in accordance with manufacturer recommendations, industry standards and guidelines and recommendations acceptable to the Administration in consideration of factors such as the operational profile of the ship, anchor handling winch and the loose gear.</u></p> <p><u>2 All loose gear is to be considered vulnerable to marine environmental conditions which may lead to significant and accelerated deterioration and corrosion, and an inspection and maintenance regime is to be implemented accordingly.</u></p> <p><u>3 Hazards particular to the inspection and maintenance of loose gear are to be considered when developing the relevant procedures for undertaking such tasks.</u></p> <p><u>4 Loose gear is to be inspected by a responsible person before each use.</u></p> <p><u>5 Particular attention is to be paid to the following (1) thorough (4).</u></p> <p><u>(1) Wear, corrosion, damage and correct functioning of loose gear</u></p> <p><u>(2) Damaged, worn or corroded chains, including their terminations</u></p> <p><u>(3) Certification, identification and marking of loose gear</u></p> <p><u>(4) Physical or chemical degradation, including degradation due to the exposure to the environment</u></p> <p><u>6 In cases where upon completion of an inspection the responsible person considers the loose gear to be unsafe for operation or otherwise not in compliance with the applicable requirements of the Administration, the loose gear is to not be used until any deficiency is rectified to the satisfaction of a</u></p>		<p>MSC.1/Circ.1662 Para 4</p> <p>MSC.1/Circ.1662 Para 4.6</p> <p>MSC.1/Circ.1662 Para 4.6.1</p> <p>MSC.1/Circ.1662 Para 4.6.2</p> <p>MSC.1/Circ.1662 Para 4.6.3</p> <p>MSC.1/Circ.1662 Para 4.6.4</p> <p>MSC.1/Circ.1662 Para 4.6.5</p> <p>MSC.1/Circ.1662 Para 4.6.6</p>

Amended-Original Requirements Comparison Table (Lifting Appliances and Anchor Handling Winches)

Amended	Original	Remarks
<p><u>competent person. The loose gear is to be clearly marked “not to be used” and the status is to be recorded. While out of service, the relevant actions for inoperative loose gear as outlined in 2.1.4 are to be followed.</u></p> <p><u>4.3.2 Operations</u></p> <p><u>The personnel involved in anchor handling winch operations which utilize loose gear is to be qualified, familiarized with the equipment and be authorized by the master.</u></p> <p><u>4.3.3 Records of Inspection and Maintenance</u></p> <p><u>1 Records of the routine inspection and maintenance of loose gear are to be maintained and kept on board.</u></p> <p><u>2 The records and particulars of inspection and maintenance may be documented in any convenient form, provided each entry contains the necessary information, is clearly legible and is authenticated by a responsible person. Any recommendations of the manufacturer for such inspection and maintenance records are to be followed.</u></p>		<p>MSC.1/Circ.1662 Para 4.5 MSC.1/Circ.1662 Para 4.5</p> <p>MSC.1/Circ.1662 Para 4.7.2</p> <p>Specifies “Records of Thorough Examination and Testing” in 2.6 MSC.1/Circ.1662 Para 4.7.2.1 MSC.1/Circ.1662 Para4.7.2.2</p>

Amended-Original Requirements Comparison Table (Lifting Appliances and Anchor Handling Winches)

Amended	Original	Remarks
<p>RULES FOR DIVING SYSTEMS</p> <p>Chapter 1 GENERAL</p> <p>1.1 General</p> <p>1.1.8 General Requirements</p> <p>20 Auxiliary Hoisting Device for Emergency Surfacing</p> <p>(1) The attendant ship is to be provided with a device to wind up the rope, the umbilical cables, etc. in place of the handling system in order to surface the diving bell together with them by releasing the drop weights in case of failure of the handling system. Where, however, the diving bell is designed to be capable of surfacing only by releasing the drop weights, this requirement does not apply.</p> <p>(2) The auxiliary hoisting device is to be designed and manufactured in accordance with the relevant requirements in <u>Part 1 of the Rules for Lifting Appliances and Anchor Handling Winches.</u></p>	<p>RULES FOR DIVING SYSTEMS</p> <p>Chapter 1 GENERAL</p> <p>1.1 General</p> <p>1.1.8 General Requirements</p> <p>20 Auxiliary Hoisting Device for Emergency Surfacing</p> <p>(1) The attendant ship is to be provided with a device to wind up the rope, the umbilical cables, etc. in place of the handling system in order to surface the diving bell together with them by releasing the drop weights in case of failure of the handling system. Where, however, the diving bell is designed to be capable of surfacing only by releasing the drop weights, this requirement does not apply.</p> <p>(2) The auxiliary hoisting device is to be designed and manufactured in accordance with the relevant requirements in <u>the Rules for Cargo Handling Appliances.</u></p>	

Amended-Original Requirements Comparison Table (Lifting Appliances and Anchor Handling Winches)

Amended	Original	Remarks
<p>Chapter 2 SURVEYS OF THE DIVING UNIT AND SYSTEMS</p> <p>2.2 Registration Surveys</p> <p>2.2.8 Survey of Handling System The handling system is to undergo tests and inspections in accordance with the following (1) to (3):</p> <ol style="list-style-type: none"> (1) Winches and the derrick systems are to undergo the tests correspondingly in accordance with <u>Part 1 of the Rules for Lifting Appliances and Anchor Handling Winches.</u> (2) Breaking tests are to be carried out for ropes correspondingly in accordance with the requirements in Part L of the Rules for the Survey and Construction of Steel Ships. (3) Proof tests are to be carried out for fittings such as hooks, shackles, blocks, etc. by a load deemed appropriate by the Society. 	<p>Chapter 2 SURVEYS OF THE DIVING UNIT AND SYSTEMS</p> <p>2.2 Registration Surveys</p> <p>2.2.8 Survey of Handling System The handling system is to undergo tests and inspections in accordance with the following (1) to (3):</p> <ol style="list-style-type: none"> (1) Winches and the derrick systems are to undergo the tests correspondingly in accordance with <u>the Rules for Cargo Handling Appliances.</u> (2) Breaking tests are to be carried out for ropes correspondingly in accordance with the requirements in Part L of the Rules for the Survey and Construction of Steel Ships. (3) Proof tests are to be carried out for fittings such as hooks, shackles, blocks, etc. by a load deemed appropriate by the Society. 	

Amended-Original Requirements Comparison Table (Lifting Appliances and Anchor Handling Winches)

Amended	Original	Remarks
<p align="center">Chapter 5 DIVING SYSTEM DESIGN, CONSTRUCTION, INSTALLATION, TESTING AND SURVEY</p> <p>5.9 Diving Launch and Recovery Systems(LARS) (2023 Diving Code 4.9)</p> <p>5.9.3 Diving Bell LARS (2023 Diving Code 4.9.3)*</p> <p>3 In order to comply with the functional criteria of -2 above, the following (1) to (10) are to be complied with.</p> <p>(1) A diving system is to be equipped with a LARS to ensure safe deployment and recovery of the diving bell between the surface compression chamber and the maximum deployment depth.</p> <p>(2) LARS is to be designed with adequate safety factors considering the environmental and operating conditions, including the dynamic loads which are encountered while handling the diving bell through the air–water interface.</p> <p>(3) LARS is to enable smooth and easily controllable handling of the diving bell.</p> <p>(4) LARS and mating devices are to enable easy and firm connection or disconnection of a diving bell to a surface compression chamber, even under conditions where the diving platform is rolling, pitching or listing to predetermined degrees.</p> <p>(5) LARS is to be equipped with mechanisms to prevent the inadvertent or inappropriate operation or overloading of any part of the diving system.</p>	<p align="center">Chapter 5 DIVING SYSTEM DESIGN, CONSTRUCTION, INSTALLATION, TESTING AND SURVEY</p> <p>5.9 Diving Launch and Recovery Systems(LARS) (2023 Diving Code 4.9)</p> <p>5.9.3 Diving Bell LARS (2023 Diving Code 4.9.3)*</p> <p>3 In order to comply with the functional criteria of -2 above, the following (1) to (10) are to be complied with.</p> <p>(1) A diving system is to be equipped with a LARS to ensure safe deployment and recovery of the diving bell between the surface compression chamber and the maximum deployment depth.</p> <p>(2) LARS is to be designed with adequate safety factors considering the environmental and operating conditions, including the dynamic loads which are encountered while handling the diving bell through the air–water interface.</p> <p>(3) LARS is to enable smooth and easily controllable handling of the diving bell.</p> <p>(4) LARS and mating devices are to enable easy and firm connection or disconnection of a diving bell to a surface compression chamber, even under conditions where the diving platform is rolling, pitching or listing to predetermined degrees.</p> <p>(5) LARS is to be equipped with mechanisms to prevent the inadvertent or inappropriate operation or overloading of any part of the diving system.</p>	

Amended-Original Requirements Comparison Table (Lifting Appliances and Anchor Handling Winches)

Amended	Original	Remarks
<p>(6) The lowering of diving bells under normal conditions are not to be controlled by brakes, but by the drive system of the winches.</p> <p>(7) Winches used for lifting personnel are to comply with <u>Part 1 of the Rules for Lifting Appliances and Anchor Handling Winches</u>, and where the power supply to the LARS fails, brakes are to be engaged automatically.</p> <p>(8) In the event of a single component failure of the LARS primary means of recovery, a secondary means of recovery is to be provided whereby the bell can be returned to the surface compression chamber. In addition, provision is to be made for safe emergency retrieval of the bell occupants to a surface compression chamber if the primary and secondary means fail.</p> <p>(9) Where a powered actuating system is used for mating operations, an auxiliary power actuating system or an appropriate alternative means are to be provided to connect a diving bell to a surface compression chamber in the event of failure of the normal power actuating system.</p> <p>(10) The design of LARS for diving bells is to consider the protection and routing of the diving umbilical to prevent damage.</p>	<p>(6) The lowering of diving bells under normal conditions are not to be controlled by brakes, but by the drive system of the winches.</p> <p>(7) Winches used for lifting personnel are to comply with <u>the Rules for Cargo Handling Appliances</u>, and where the power supply to the LARS fails, brakes are to be engaged automatically.</p> <p>(8) In the event of a single component failure of the LARS primary means of recovery, a secondary means of recovery is to be provided whereby the bell can be returned to the surface compression chamber. In addition, provision is to be made for safe emergency retrieval of the bell occupants to a surface compression chamber if the primary and secondary means fail.</p> <p>(9) Where a powered actuating system is used for mating operations, an auxiliary power actuating system or an appropriate alternative means are to be provided to connect a diving bell to a surface compression chamber in the event of failure of the normal power actuating system.</p> <p>(10) The design of LARS for diving bells is to consider the protection and routing of the diving umbilical to prevent damage.</p>	
<p>5.9.4 Surface Orientated Diving LARS (2023 Diving Code 4.9.4)*</p> <p>3 In order to comply with the functional criteria of -2 above, the following (1) to (9) are to be complied with.</p> <p>(1) A diving system is to be equipped with a LARS to ensure deployment and recovery of a dive basket or wet bell to and from the maximum deployment depth.</p>	<p>5.9.4 Surface Orientated Diving LARS (2023 Diving Code 4.9.4)*</p> <p>3 In order to comply with the functional criteria of -2 above, the following (1) to (9) are to be complied with.</p> <p>(1) A diving system is to be equipped with a LARS to ensure deployment and recovery of a dive basket or wet bell to and from the maximum deployment depth.</p>	

Amended-Original Requirements Comparison Table (Lifting Appliances and Anchor Handling Winches)

Amended	Original	Remarks
<p>(2) Where applicable, a diving system is to be equipped with a LARS to ensure the safe launch and recovery of a diving daughter-craft to and from the water.</p> <p>(3) LARS is to be designed with adequate safety factors considering the environmental and operating conditions, including the dynamic loads which are encountered while launching and recovering the dive basket or wet bell through the air–water interface.</p> <p>(4) LARS is to enable smooth and easily controllable handling of the dive basket, wet bell or daughter-craft. LARS and restraint devices are to enable easy and controlled handling of the dive basket, wet bell or daughter-craft when recovered to the embarkation point, even under conditions where the diving platform is rolling, pitching or listing to predetermined degrees.</p> <p>(5) The lowering of dive basket, wet bell or daughter-craft under normal conditions are not to be controlled by brakes, but by the drive system of the winches.</p> <p>(6) Winches used for lifting personnel are to comply with <u>Part 1 of the Rules for Lifting Appliances and Anchor Handling Winches</u>, and where the power supply to the LARS fails, brakes are to be engaged automatically.</p> <p>(7) In the event of a single component failure of the LARS, an alternative means is to be provided whereby the dive basket, wet bell, divers or daughter-craft occupants can be returned to the embarkation point. Where the working divers and the standby divers LARS are combined then the failure of a single component is not to compromise the ability of the standby system to perform an emergency recovery.</p> <p>(8) The design of LARS that manage the diver's umbilical</p>	<p>(2) Where applicable, a diving system is to be equipped with a LARS to ensure the safe launch and recovery of a diving daughter-craft to and from the water.</p> <p>(3) LARS is to be designed with adequate safety factors considering the environmental and operating conditions, including the dynamic loads which are encountered while launching and recovering the dive basket or wet bell through the air–water interface.</p> <p>(4) LARS is to enable smooth and easily controllable handling of the dive basket, wet bell or daughter-craft. LARS and restraint devices are to enable easy and controlled handling of the dive basket, wet bell or daughter-craft when recovered to the embarkation point, even under conditions where the diving platform is rolling, pitching or listing to predetermined degrees.</p> <p>(5) The lowering of dive basket, wet bell or daughter-craft under normal conditions are not to be controlled by brakes, but by the drive system of the winches.</p> <p>(6) Winches used for lifting personnel are to comply with <u>the Rules for Cargo Handling Appliances</u>, and where the power supply to the LARS fails, brakes are to be engaged automatically.</p> <p>(7) In the event of a single component failure of the LARS, an alternative means is to be provided whereby the dive basket, wet bell, divers or daughter-craft occupants can be returned to the embarkation point. Where the working divers and the standby divers LARS are combined then the failure of a single component is not to compromise the ability of the standby system to perform an emergency recovery.</p> <p>(8) The design of LARS that manage the diver's umbilical</p>	

Amended-Original Requirements Comparison Table (Lifting Appliances and Anchor Handling Winches)

Amended	Original	Remarks
<p>is to consider the protection and routing of the diving umbilical to prevent damage.</p> <p>(9) LARS for primary access and egress is not required where the diver has to climb no more than 2 <i>m</i> above the water surface on a ladder, or no more than 4 <i>m</i> on stairs. However, the stairs are to be fitted with a handrail and provided with the following means (a) and (b).</p> <p>(a) Means for diver access and egress from the water.</p> <p>(b) Means to recover a helpless diver in an emergency.</p>	<p>is to consider the protection and routing of the diving umbilical to prevent damage.</p> <p>(9) LARS for primary access and egress is not required where the diver has to climb no more than 2 <i>m</i> above the water surface on a ladder, or no more than 4 <i>m</i> on stairs. However, the stairs are to be fitted with a handrail and provided with the following means (a) and (b).</p> <p>(a) Means for diver access and egress from the water.</p> <p>(b) Means to recover a helpless diver in an emergency.</p>	

DRAFT

Amended-Original Requirements Comparison Table (Lifting Appliances and Anchor Handling Winches)

Amended	Original	Remarks
<p align="center">RULES FOR THE SURVEY AND CONSTRUCTION OF PASSENGER SHIPS</p> <p>Part 10 PASSENGER SUBMERSIBLE CRAFT</p> <p align="center">Chapter 6 SUPPORT SYSTEMS</p> <p>6.1 Support Systems</p> <p>6.1.1 General*</p> <p>1 Support systems, in general, are to be composed of the support facilities specified below.</p> <p>(1) Towing systems which have sufficient capacity and strength to tow the submersible safely and passed through tests considered appropriate by the Society</p> <p>(2) Launch and recovery systems or cranes which are designed and manufactured by applying the requirements of <u>Part 1 of the Rules for Lifting Appliances and Anchor Handling Winches</u> by regarding the design lifting load or a load considered appropriate by the Society as the safe working load</p> <p>(3) Systems related to recharging of power supply, high pressure air and life support.</p> <p>(4) Communication systems with the land support station or other ships</p> <p>(5) Devices to detect positions of the submersible corresponding to those specified in 4.2.7</p>	<p align="center">RULES FOR THE SURVEY AND CONSTRUCTION OF PASSENGER SHIPS</p> <p>Part 10 PASSENGER SUBMERSIBLE CRAFT</p> <p align="center">Chapter 6 SUPPORT SYSTEMS</p> <p>6.1 Support Systems</p> <p>6.1.1 General*</p> <p>1 Support systems, in general, are to be composed of the support facilities specified below.</p> <p>(1) Towing systems which have sufficient capacity and strength to tow the submersible safely and passed through tests considered appropriate by the Society</p> <p>(2) Launch and recovery systems or cranes which are designed and manufactured by applying the requirements of <u>the Rules for Cargo Handling Appliances</u> by regarding the design lifting load or a load considered appropriate by the Society as the safe working load</p> <p>(3) Systems related to recharging of power supply, high pressure air and life support.</p> <p>(4) Communication systems with the land support station or other ships</p> <p>(5) Devices to detect positions of the submersible corresponding to those specified in 4.2.7</p>	

Amended-Original Requirements Comparison Table (Lifting Appliances and Anchor Handling Winches)

Amended	Original	Remarks
<p>(6) Communication systems corresponding to those specified in 4.5</p> <p>(7) Ladders</p> <p>(8) Loudspeakers</p> <p>(9) Search lights</p> <p>(10) Others deemed necessary by the Society in consideration of the operation scheme of the submersible</p> <p align="center">Chapter 7 TESTS</p> <p>7.2 Tests</p> <p>7.2.5 Tests for Support Systems Facilities for support systems are to undergo the tests specified below.</p> <p>(1) Performance tests on underwater communication systems and devices to detect positions of the submersible on sea trials at the maximum diving depth</p> <p>(2) The following tests on towing systems, housing systems, launch and recovery systems or cranes for lifting the submersible</p> <p>(a) As for the towing systems, tests to confirm the effectiveness of the systems</p> <p>(b) As for the housing systems, tests to confirm the effectiveness of the systems</p> <p>(c) As for the launch and recovery systems or cranes for lifting the submersible, tests correspondingly regarded to those specified in 2.4 and 2.5, Part 1</p>	<p>(6) Communication systems corresponding to those specified in 4.5</p> <p>(7) Ladders</p> <p>(8) Loudspeakers</p> <p>(9) Search lights</p> <p>(10) Others deemed necessary by the Society in consideration of the operation scheme of the submersible</p> <p align="center">Chapter 7 TESTS</p> <p>7.2 Tests</p> <p>7.2.5 Tests for Support Systems Facilities for support systems are to undergo the tests specified below.</p> <p>(1) Performance tests on underwater communication systems and devices to detect positions of the submersible on sea trials at the maximum diving depth</p> <p>(2) The following tests on towing systems, housing systems, launch and recovery systems or cranes for lifting the submersible</p> <p>(a) As for the towing systems, tests to confirm the effectiveness of the systems</p> <p>(b) As for the housing systems, tests to confirm the effectiveness of the systems</p> <p>(c) As for the launch and recovery systems or cranes for lifting the submersible, tests correspondingly regarded to those specified in 2.4 and 2.5 of the</p>	

Amended-Original Requirements Comparison Table (Lifting Appliances and Anchor Handling Winches)

Amended	Original	Remarks
<p align="center"><u>of the Rules for Lifting Appliances and Anchor Handling Winches</u></p>	<p align="center"><u>Rules for Cargo Handling Appliances</u></p>	

DRAFT

Amended-Original Requirements Comparison Table (Lifting Appliances and Anchor Handling Winches)

Amended	Original	Remarks
<p align="center">RULES FOR THE SURVEY AND CONSTRUCTION OF INLAND WATERWAY SHIPS</p> <p align="center">Part 4 HULL CONSTRUCTION AND EQUIPMENT OF TUGS AND PUSHERS</p> <p align="center">Chapter 16 EQUIPMENT</p> <p>16.2 Equipment for Special Purpose</p> <p>16.2.2 Tugs*</p> <p>1 General</p> <p>(1) In cases where equipment and devices for the ship's purpose are fitted, suitable measures are to be taken so that ship safety is not impaired.</p> <p>(2) <u>Lifting appliance</u> is to be in accordance with Part 1 of the Rules for Lifting Appliance and Anchor Handling Winches and at the discretion of the Society.</p>	<p align="center">RULES FOR THE SURVEY AND CONSTRUCTION OF INLAND WATERWAY SHIPS</p> <p align="center">Part 4 HULL CONSTRUCTION AND EQUIPMENT OF TUGS AND PUSHERS</p> <p align="center">Chapter 16 EQUIPMENT</p> <p>16.2 Equipment for Special Purpose</p> <p>16.2.2 Tugs*</p> <p>1 General</p> <p>(1) In cases where equipment and devices for the ship's purpose are fitted, suitable measures are to be taken so that ship safety is not impaired.</p> <p>(2) <u>Cargo gear</u> is to be in accordance with Rules for Cargo Handling Appliances and at the discretion of the Society.</p>	

Amended-Original Requirements Comparison Table (Lifting Appliances and Anchor Handling Winches)

Amended	Original	Remarks
<p align="center">RULES FOR FLOATING DOCKS</p> <p align="center">Chapter 1 GENERAL RULES</p> <p>1.1 General</p> <p>1.1.5 Cranes When the assignment of safe working load of cranes is requested by the builders or the owners, the Society will assign the safe working load in accordance with <u>Part 1 of the Rules for Lifting Appliances and Anchor Handling Winches.</u></p>	<p align="center">RULES FOR FLOATING DOCKS</p> <p align="center">Chapter 1 GENERAL RULES</p> <p>1.1 General</p> <p>1.1.5 Cranes When the assignment of safe working load of cranes is requested by the builders or the owners, the Society will assign the safe working load in accordance with <u>the Rules for Cargo Handling Appliances.</u></p>	

Amended-Original Requirements Comparison Table (Lifting Appliances and Anchor Handling Winches)

Amended	Original	Remarks
<p align="center">GUIDANCE FOR THE CLASSIFICATION AND REGISTRY OF SHIPS</p> <p align="center">Chapter 3 REGISTRATION OF INSTALLATIONS</p> <p>3.1 Installations Registration</p> <p>3.1.1 General “The rules for the survey and construction of installations provided separately” referred to in 3.1.1 of the Regulations are the Society’s technical rules given in Table 1 of this Guidance.</p>	<p align="center">GUIDANCE FOR THE CLASSIFICATION AND REGISTRY OF SHIPS</p> <p align="center">Chapter 3 REGISTRATION OF INSTALLATIONS</p> <p>3.1 Installations Registration</p> <p>3.1.1 General “The rules for the survey and construction of installations provided separately” referred to in 3.1.1 of the Regulations are the Society’s technical rules given in Table 1 of this Guidance.</p>	

Amended-Original Requirements Comparison Table (Lifting Appliances and Anchor Handling Winches)

Amended	Original	Remarks
Table 1 Rules for the Survey and Construction of Installations		
Name of Installations	Name of Rules	
Cargo Refrigerating Installations	Rules for Cargo Refrigerating Installations	
Cargo Handling-Lifting Appliances and Anchor Handling Winches	Rules for Cargo Handling Lifting Appliances and Anchor Handling Winches	Adds anchor handling winches
Marine Pollution Prevention Installations	Rules for Marine Pollution Prevention Systems	
Safety Equipment	Rules for Safety Equipment	
Radio Installations	Rules for Radio Installations	
Automatic and Remote Control Systems	Rules for Automatic and Remote Control Systems	
Navigation Bridge Systems	Rules for Navigation Bridge Systems	
Diving Systems	Rules for Diving Systems	
Preventive Machinery Maintenance Systems	Rules for Preventive Machinery Maintenance Systems	
Integrated Fire Control Systems	Rules for Integrated Fire Control Systems	
Hull Monitoring Systems	Rules for Hull Monitoring Systems	
Anti-Fouling Systems on Ships	Rules for Anti-Fouling Systems on Ships	
Centralized Cargo Monitoring and Control Systems	Rules for Centralized Cargo Monitoring and Control Systems	
Ballast Water Management Installations	Rules for Ballast Water Management Installations	
Inventory of Hazardous Materials	Rules for the Ship Recycling	

Amended-Original Requirements Comparison Table (Lifting Appliances and Anchor Handling Winches)

Amended	Original	Remarks
<p align="center">GUIDANCE FOR THE SURVEY AND CONSTRUCTION OF STEEL SHIPS</p> <p align="center">Part U INTACT STABILITY</p> <p align="center">U1 GENERAL</p> <p>U1.1 General</p> <p>U1.1.1 Application</p> <p>4 “Where deemed as necessary by the Society” specified in 1.1.1-4, Part U of the Rules means in cases where the ship is not to be secured by mooring at jetties, etc. or another equivalent method, and is intended to operate for lifts in the floating condition. In such cases, intact stability during lifting operations is to be subject to stability requirements separately specified by the Society for the following ships:</p> <p>(1) Ships intended to operate involving the lifting of the ship’s own structures or for lifts in which the maximum heeling moment due to the lift is greater than that given in the following. The calculations are to be completed at the most unfavourable loading conditions for which the lifting <u>appliance</u> is to be used.</p> $M_L = 0.67 \times \Delta \times G_0M \times \left(\frac{f}{B}\right)$ <p>M_L : Threshold value for the heeling moment,</p>	<p align="center">GUIDANCE FOR THE SURVEY AND CONSTRUCTION OF STEEL SHIPS</p> <p align="center">Part U INTACT STABILITY</p> <p align="center">U1 GENERAL</p> <p>U1.1 General</p> <p>U1.1.1 Application</p> <p>4 “Where deemed as necessary by the Society” specified in 1.1.1-4, Part U of the Rules means in cases where the ship is not to be secured by mooring at jetties, etc. or another equivalent method, and is intended to operate for lifts in the floating condition. In such cases, intact stability during lifting operations is to be subject to stability requirements separately specified by the Society for the following ships:</p> <p>(1) Ships intended to operate involving the lifting of the ship’s own structures or for lifts in which the maximum heeling moment due to the lift is greater than that given in the following. The calculations are to be completed at the most unfavourable loading conditions for which the lifting <u>equipment</u> is to be used.</p> $M_L = 0.67 \times \Delta \times G_0M \times \left(\frac{f}{B}\right)$ <p>M_L : Threshold value for the heeling moment,</p>	<p>Amends to lifting</p>

Amended-Original Requirements Comparison Table (Lifting Appliances and Anchor Handling Winches)

Amended	Original	Remarks
<p>in $(t \cdot m)$, induced by the lifting <u>appliance</u> and <u>the</u> load in the lifting <u>appliance</u>.</p> <p>G_0M : The initial metacentric height, in (m), with free surface correction, including the effect of the lifting <u>appliance</u> and <u>the</u> load in the lifting <u>appliance</u>.</p> <p>f : the minimum freeboard, in (m), measured from the upper side of the weather deck to the waterline.</p> <p>B : the moulded breadth of the ship, in (m), as defined in 2.1.4, Part A of the Rules.</p> <p>Δ : the displacement of the ship, including the lift load, in (t).</p> <p>(2) Ships which are engaged in lifting operations where no transverse heeling moment is induced and the increase of the ship's vertical centre of gravity (VCG) due to the lifted weight is greater than 1%.</p>	<p>in $(t \cdot m)$, induced by the (lifting <u>equipment</u> and) load in the lifting <u>equipment</u>.</p> <p>G_0M : The initial metacentric height, in (m), with free surface correction, including the effect of the (lifting <u>equipment</u> and) load in the lifting <u>equipment</u>.</p> <p>f : the minimum freeboard, in (m), measured from the upper side of the weather deck to the waterline.</p> <p>B : the moulded breadth of the ship, in (m), as defined in 2.1.4, Part A of the Rules.</p> <p>Δ : the displacement of the ship, including the lift load, in (t).</p> <p>(2) Ships which are engaged in lifting operations where no transverse heeling moment is induced and the increase of the ship's vertical centre of gravity (VCG) due to the lifted weight is greater than 1%.</p>	<p>appliance</p>

Amended-Original Requirements Comparison Table (Lifting Appliances and Anchor Handling Winches)

Amended	Original	Remarks
<p>GUIDANCE FOR THE SURVEY AND CONSTRUCTION OF STEEL SHIPS</p> <p>Part D MACHINERY INSTALLATIONS</p> <p>D1 GENERAL</p> <p>D1.1 General</p> <p>D1.1.6 Terminology</p>	<p>GUIDANCE FOR THE SURVEY AND CONSTRUCTION OF STEEL SHIPS</p> <p>Part D MACHINERY INSTALLATIONS</p> <p>D1 GENERAL</p> <p>D1.1 General</p> <p>D1.1.6 Terminology</p>	

Table D1.1.6-1 Kinds of Auxiliaries

Kind of auxiliary	Auxiliary machinery items
Auxiliary machinery for cooling systems	Jacket cooling water pumps, Piston cooling water (oil) pumps, Fuel valve cooling water (oil) pumps, Turbocharger cooling water pumps, Circulating water pumps, Cooler cooling water pumps, Generator engine cooling water (oil) pumps, Air compressors cooling water pumps
Auxiliary machinery for feed water, condensate and draining systems	Boiler water circulating pumps, Condensate pumps, Exhaust gas economizer feed pumps, Drain pumps, Feed water pumps
Auxiliary machinery for fuel oil systems	F.O. supply (service) pumps, F.O. transfer pumps, Boiler burning pumps, F.O. purifiers
Auxiliary machinery for lubricating oil systems	Cam shaft L.O. pumps, Turbocharger L.O. pumps, Crosshead L.O. pumps, Reduction gear L.O. pumps, Stern tube L.O. pumps (not applicable for gravitational circulation systems), L.O. purifiers
Auxiliary machinery for hydraulic systems	Hydraulic oil pumps (pumps to supply hydraulic oil to hydraulic circuits for driving or controlling equipment relevant to main propulsion, e.g., controllable pitch propeller oil pumps)

Amended-Original Requirements Comparison Table (Lifting Appliances and Anchor Handling Winches)

Amended		Original	Remarks
	Other auxiliary machinery	Vacuum pumps for condensers, Gland steam exhaust fans, Boiler draught fans, Air compressors (excluding air compressors for emergency use), Distilling plants (when distillate is used for main boilers or other essential auxiliary boilers), Others as deemed essential by the Society.	
Auxiliary machinery for manoeuvring and safety	Pumps	Bilge pumps (including pumps for oil-water separators*), Ballast pumps, Fire pumps* (including emergency fire pumps), Fuel oil supply pumps for gas combustion units (GCUs) of gas-fuelled ships	
	Steering-related auxiliary machinery	Steering engines, Side thrusters*, Stabilizers	
	Deck machinery	Windlasses, Mooring winches*, Hydraulic pumps used for windlasses, Hydraulic pumps used for mooring winches*	
	Ventilating fans, blowers, etc.	Ventilating fans (installed in hazardous areas due to flammable gases or gases harmful to the health of personnel in engine room*, boiler room*, cargo oil pump room of oil tanker), Ventilating fans for cargo oil tanks, Gas-free fans and inert gas blowers of oil tanker, Blower fans for gas combustion units (GCUs) of gas-fuelled ships, Others as deemed essential by the Society.	
Auxiliary machinery for cargo handling	Cargo handling machinery and gear	Hydraulic pumps used for Cargo handling lifting appliances (items subject to <u>Part 1 of the "Rules for the Survey and Construction of Cargo Handling Appliances of Ships"</u> <u>Rules for Lifting Appliances and Anchor Handling Winches</u>), Hoisting machinery, Operating equipment	
	Auxiliary machinery for specific use of oil tanker, ships carrying liquefied gases in bulk and ships carrying dangerous chemicals in bulk	Cargo pumps, Stripping pumps, Tank cleaning pumps, Gas compressors, Pumps used for gas cooling system, Gas refrigerating compressors, Fuel oil supply pumps and blower fans for gas combustion units (GCUs) of ships carrying liquefied gases in bulk	
	Auxiliary machinery for cargo refrigerating installation	Compressors, Liquid pumps and Condenser cooling pumps used for cargo refrigerating machinery (including items subject to "Rules for the Survey and Construction of Cargo Refrigerating Installation of Ships" <u>Rules for Cargo Refrigerating Installations</u>)	
	Other auxiliary machinery	Others as deemed essential by the Society	
Auxiliary machinery for specific use	Cargo handling equipment for specific Use	Unloaders (Shipborne units), Refrigerating machines for heat insulated containers, etc.	
	Public working equipment	Dredging equipment, Drilling machines, Pile-driving equipment, etc.	
	Fishing equipment	Winches, etc.	
	Marine-products processing equipment	Canning/packing equipment, Conveyors, Ice-making machines, etc.	
	Equipment for specific operations	Equipment specifically designated by the Society	

Amended-Original Requirements Comparison Table (Lifting Appliances and Anchor Handling Winches)

Amended	Original	Remarks
Remarks: For those items of auxiliary machinery marked by an asterisk, see D1.1.4(4)		

DRAFT

Amended-Original Requirements Comparison Table (Lifting Appliances and Anchor Handling Winches)

Amended	Original	Remarks
<p align="center">GUIDANCE FOR THE SURVEY AND CONSTRUCTION OF STEEL SHIPS</p> <p align="center">Part O WORK-SHIPS</p> <p align="center">O3 CRANE SHIPS</p> <p>O3.4Hull Equipment</p> <p>O3.4.1 General “At the discretion of the Society” referred to in 3.4.1-3, Part O of the Rules is to be in accordance with the requirements in the <u>Part 1 of the Rules for Lifting Appliances and Anchor Handling Winches</u>.</p> <p align="center">O4 VESSELS ENGAGED IN TOWING OPERATION</p> <p>O4.4Hull Equipment</p> <p>O4.4.1 General “At the discretion of the Society” referred to in 4.4.1-3, Part O of the Rules is to be in accordance with the requirements in the <u>Part 1 of the Rules for Lifting Appliances and Anchor Handling Winches</u>.</p>	<p align="center">GUIDANCE FOR THE SURVEY AND CONSTRUCTION OF STEEL SHIPS</p> <p align="center">Part O WORK-SHIPS</p> <p align="center">O3 CRANE SHIPS</p> <p>O3.4Hull Equipment</p> <p>O3.4.1 General “At the discretion of the Society” referred to in 3.4.1-3, Part O of the Rules is to be in accordance with the requirements in the <u>Rules for Cargo Handling Appliances</u>.</p> <p align="center">O4 VESSELS ENGAGED IN TOWING OPERATION</p> <p>O4.4Hull Equipment</p> <p>O4.4.1 General “At the discretion of the Society” referred to in 4.4.1-3, Part O of the Rules is to be in accordance with the requirements in the <u>Rules for Cargo Handling Appliances</u>.</p>	

Amended-Original Requirements Comparison Table (Lifting Appliances and Anchor Handling Winches)

Amended	Original	Remarks
<p align="center">O7 OFFSHORE SUPPLY VESSELS</p> <p>O7.4 Hull Equipment</p> <p>O7.4.1 General “At the discretion of the Society” referred to in 7.4.1-3, Part O of the Rules is to be in accordance with the requirements in the <u>Part 1 of the Rules for Lifting Appliances and Anchor Handling Winches</u>.</p> <p align="center">O8 ANCHOR HANDLING VESSELS</p> <p>O8.3 Hull Construction</p> <p>O8.3.2 Supporting Structures of Anchor Handling Equipment</p> <p>With respect to the provisions of 8.3.2, Part O of the Rules, the allowable stress values for each member of the supporting structures in way of parts where anchors are stored as cargo are, in principle, to be as given below. Different values, however, may be used in consideration of the arrangements, etc. of the supporting structures.</p> <p> $\sigma = 166/K(N/mm^2)$ $\tau = 96/K(N/mm^2)$ $\sigma_e = 196/K(N/mm^2)$ $\sigma: \sigma_a + \sigma_b$ (Normal stress) σ_a: Axial stress </p>	<p align="center">O7 OFFSHORE SUPPLY VESSELS</p> <p>O7.4 Hull Equipment</p> <p>O7.4.1 General “At the discretion of the Society” referred to in 7.4.1-3, Part O of the Rules is to be in accordance with the requirements in the <u>Rules for Cargo Handling Appliances</u>.</p> <p align="center">O8 ANCHOR HANDLING VESSELS</p> <p>O8.3 Hull Construction</p> <p>O8.3.2 Supporting Structures of Anchor Handling Equipment</p> <p>With respect to the provisions of 8.3.2, Part O of the Rules, the allowable stress values for each member of the supporting structures <u>of anchor handling equipment and</u> in way of parts where anchors are stored as cargo are, in principle, to be as given below. Different values, however, may be used in consideration of the arrangements, etc. of the supporting structures.</p> <p> $\sigma = 166/K(N/mm^2)$ $\tau = 96/K(N/mm^2)$ $\sigma_e = 196/K(N/mm^2)$ $\sigma: \sigma_a + \sigma_b$ (Normal stress) σ_a: Axial stress </p>	<p>Transfers the requirements for the supporting structures of anchor handling winches to "1.3.2-1, Part 2 of the Rules for Lifting Appliances and Anchor Handling Winches"</p>

Amended-Original Requirements Comparison Table (Lifting Appliances and Anchor Handling Winches)

Amended	Original	Remarks
<p>σ_b: Bending stress τ: Shearing stress in plane σ_e: $\sigma_e = \sqrt{\sigma^2 + 3\tau^2}$ (Equivalent stress) <i>K</i>: Coefficient corresponding to the kind of steel <i>e.g.</i> 1.0 for mild steel, the values specified in 3.2.1.2-2, Part 1, Part C of the Rules for high tensile steel</p> <p>O8.4Hull Equipment</p> <p>O8.4.1 General “At the discretion of the Society” referred to in 8.4.1-3, Part O of the Rules is to be in accordance with the requirements in the <u>Part 1 of the Rules for Lifting Appliances and Anchor Handling Winches</u>.</p> <p>O9 VESSELS ENGAGED IN LAYING OBJECTS ON THE SEABED</p> <p>O9.4Hull Equipment</p> <p>O9.4.1 General “At the discretion of the Society” referred to in 9.4.1-3, Part O of the Rules is to be in accordance with the requirements in the <u>Part 1 of the Rules for Lifting Appliances and Anchor Handling Winches</u>.</p>	<p>σ_b: Bending stress τ: Shearing stress in plane σ_e: $\sigma_e = \sqrt{\sigma^2 + 3\tau^2}$ (Equivalent stress) <i>K</i>: Coefficient corresponding to the kind of steel <i>e.g.</i> 1.0 for mild steel, the values specified in 3.2.1.2-2, Part 1, Part C of the Rules for high tensile steel</p> <p>O8.4Hull Equipment</p> <p>O8.4.1 General “At the discretion of the Society” referred to in 8.4.1-3, Part O of the Rules is to be in accordance with the requirements in the <u>Rules for Cargo Handling Appliances</u>.</p> <p>O9 VESSELS ENGAGED IN LAYING OBJECTS ON THE SEABED</p> <p>O9.4Hull Equipment</p> <p>O9.4.1 General “At the discretion of the Society” referred to in 9.4.1-3, Part O of the Rules is to be in accordance with the requirements in the <u>Rules for Cargo Handling Appliances</u>.</p>	

Amended-Original Requirements Comparison Table (Lifting Appliances and Anchor Handling Winches)

Amended	Original	Remarks
<p align="center">GUIDANCE FOR THE SURVEY AND CONSTRUCTION OF STEEL SHIPS</p> <p align="center">Part P MOBILE OFFSHORE DRILLING UNITS AND SPECIAL PURPOSE BARGES</p> <p align="center">P1 GENERAL</p> <p>P1.1 General</p> <p>P1.1.6 Class Notations 1 With respect to units complying with relevant requirements given in this Part, notations corresponding to the purposes of those units defined in 1.2.3, Part P of the Rules are affixed to the Classification Characters as follows.</p> <p>(1) Mobile offshore drilling units</p> <p>(a) Self-elevating mobile offshore drilling units: <i>Self-Elevating Drilling Unit</i> (abbreviated to <i>SEDU</i>)</p> <p>(b) Column-stabilized mobile offshore drilling units: <i>Column-Stabilized Drilling Unit</i> (abbreviated to <i>CSDU</i>)</p> <p>(c) Ship-type mobile offshore drilling units: <i>Drilling Vessel</i> (abbreviated to <i>DV</i>)</p> <p>(d) Barge-type mobile offshore drilling units: <i>Drilling Barge</i> (abbreviated to <i>DB</i>)</p> <p>In addition, for units complying with the following requirements in addition to requirements in this part, the notation of “<i>Mobile</i></p>	<p align="center">GUIDANCE FOR THE SURVEY AND CONSTRUCTION OF STEEL SHIPS</p> <p align="center">Part P MOBILE OFFSHORE DRILLING UNITS AND SPECIAL PURPOSE BARGES</p> <p align="center">P1 GENERAL</p> <p>P1.1 General</p> <p>P1.1.6 Class Notations 1 With respect to units complying with relevant requirements given in this Part, notations corresponding to the purposes of those units defined in 1.2.3, Part P of the Rules are affixed to the Classification Characters as follows.</p> <p>(1) Mobile offshore drilling units</p> <p>(a) Self-elevating mobile offshore drilling units: <i>Self-Elevating Drilling Unit</i> (abbreviated to <i>SEDU</i>)</p> <p>(b) Column-stabilized mobile offshore drilling units: <i>Column-Stabilized Drilling Unit</i> (abbreviated to <i>CSDU</i>)</p> <p>(c) Ship-type mobile offshore drilling units: <i>Drilling Vessel</i> (abbreviated to <i>DV</i>)</p> <p>(d) Barge-type mobile offshore drilling units: <i>Drilling Barge</i> (abbreviated to <i>DB</i>)</p> <p>In addition, for units complying with the following requirements in addition to requirements in this part, the notation of “<i>Mobile</i></p>	

Amended-Original Requirements Comparison Table (Lifting Appliances and Anchor Handling Winches)

Amended	Original	Remarks
<p><i>offshore Drilling Unit</i>” (abbreviated to <i>MODU</i>) is affixed. (For example, in the case of self-elevating mobile offshore drilling units, <i>Mobile Offshore Drilling Unit/ Self-Elevating Drilling Unit</i> (abbreviated to <i>MODU/SEDU</i>)</p> <p>(a) 1.1.1-2 of the Rules for Safety Equipment</p> <p>(b) 1.1.1-3 of the Rules for Radio Installations</p> <p>(c) The Rules for Anti-Fouling Systems on Ships</p> <p>(2) Storage units: <i>Storage Barge</i> (abbreviated to <i>SB</i>) In cases where oil is stored, the notation to be affixed is “<i>Oil Storage Barge</i>”, and additional descriptions regarding flash points of oil are affixed. (For example, <i>Oil Storage Barge, Flash point below 60 °C</i>)</p> <p>(3) Moored floating units: Notations corresponding to the purpose of such units are affixed. (For example, Hotel ships: <i>Floating Hotel</i> (abbreviated to <i>FH</i>))</p> <p>(4) Plant barges: Notations corresponding to the types of installed industrial factories are affixed. (For example, Plant barges for generating electricity: <i>Power Plant Barge</i> (abbreviated to <i>PPB</i>))</p> <p>(5) Accommodation barges: <i>Accommodation Barge</i> (abbreviated to <i>AB</i>)</p>	<p><i>offshore Drilling Unit</i>” (abbreviated to <i>MODU</i>) is affixed. (For example, in the case of self-elevating mobile offshore drilling units, <i>Mobile Offshore Drilling Unit/ Self-Elevating Drilling Unit</i> (abbreviated to <i>MODU/SEDU</i>)</p> <p>(a) 1.1.1-2 of the Rules for Safety Equipment</p> <p>(b) 1.1.1-3 of the Rules for Cargo Handling Appliances</p> <p>(c) 1.1.1-3 of the Rules for Radio Installations</p> <p>(d) The Rules for Anti-Fouling Systems on Ships</p> <p>(2) Storage units: <i>Storage Barge</i> (abbreviated to <i>SB</i>) In cases where oil is stored, the notation to be affixed is “<i>Oil Storage Barge</i>”, and additional descriptions regarding flash points of oil are affixed. (For example, <i>Oil Storage Barge, Flash point below 60 °C</i>)</p> <p>(3) Moored floating units: Notations corresponding to the purpose of such units are affixed. (For example, Hotel ships: <i>Floating Hotel</i> (abbreviated to <i>FH</i>))</p> <p>(4) Plant barges: Notations corresponding to the types of installed industrial factories are affixed. (For example, Plant barges for generating electricity: <i>Power Plant Barge</i> (abbreviated to <i>PPB</i>))</p> <p>(5) Accommodation barges: <i>Accommodation Barge</i> (abbreviated to <i>AB</i>)</p>	

Amended-Original Requirements Comparison Table (Lifting Appliances and Anchor Handling Winches)

Amended	Original	Remarks
<p style="text-align: center;"><u>GUIDANCE FOR LIFTING APPLIANCES AND ANCHOR HANDLING WINCHES</u></p> <p style="text-align: center;"><u>Part 1 LIFTING APPLIANCES</u></p> <p style="text-align: center;">Chapter 1 GENERAL</p> <p>1.1 General</p> <p>1.1.2 Equivalency 1 “Rules and standards recognized by the Society to be appropriate” specified in 1.1.2-2, Part 1 of the Rules mean, as a rule, <i>JIS B 8821</i> (Specification for the Design of Crane Structures) or other standards or rules equivalent thereto. 2 “Tests and inspection required by the Society” specified in 1.1.2-2, Part 1 of the Rules mean, as a rule, the Design Examination specified in 2.3.1, Part 1 of the Rules and the Work Examination specified in 2.3.2 thereof. However, the Society may dispense with part of the plan investigation and examination for the machinery and gear which passed the plan investigation and examination of the official or third-party organizations considered appropriate by the Society and were certified by them.</p> <p>1.1.3 Precautions in Application 1 For ships flying Greek flags, the rules of the Greek Government concerning the <u>lifting appliances</u> are to be complied with in addition to the Rules. The rules of the Greek Government are applied to all power driven <u>lifting appliances</u></p>	<p style="text-align: center;"><u>GUIDANCE FOR CARGO HANDLING APPLIANCES</u></p> <p style="text-align: center;">(Newly added)</p> <p style="text-align: center;">Chapter 1 GENERAL</p> <p>1.1 General</p> <p>1.1.2 Equivalency 1 “Rules and standards recognized by the Society to be appropriate” specified in 1.1.2-2 of the Rules mean, as a rule, <i>JIS B 8821</i> (Specification for the Design of Crane Structures) or other standards or rules equivalent thereto. 2 “Tests and inspection required by the Society” specified in 1.1.2-2 of the Rules mean, as a rule, the Design Examination specified in 2.3.1 of the Rules and the Work Examination specified in 2.3.2 thereof. However, the Society may dispense with part of the plan investigation and examination for the machinery and gear which passed the plan investigation and examination of the official or third-party organizations considered appropriate by the Society and were certified by them.</p> <p>1.1.3 Precautions in Application 1 For ships flying Greek flags, the rules of Greek Government concerning the <u>cargo gear</u> are to be complied with in addition to the Rules. The rules of Greek Government are applied to all power driven <u>cargo gear</u> regardless of their</p>	

Amended-Original Requirements Comparison Table (Lifting Appliances and Anchor Handling Winches)

Amended	Original	Remarks
<p>regardless of their safe working loads and services intended.</p> <p>2 Attention is to be paid to the fact that some states of call require to hold certificates of <u>a special form specified by themselves</u> in addition to the certificates specified in 9.4.1, Part 1 of the Rules and issued by the Society.</p> <p>1.2 Definitions</p> <p>1.2.1 Terminology</p> <p>(Same)</p> <p>1.3 Arrangement, Construction, Materials and Welding</p> <p>1.3.2 General Construction</p> <p>1 The <u>lifting appliances</u> which are to comply with the additional requirements considered appropriate by the Society in applying the Rules as specified in 1.3.2-1, Part 1 of the Rules include the following (1) through (4):</p> <ol style="list-style-type: none"> (1) <u>Lifting appliances</u> installed on workboats (2) Hoisting and stowing equipment for submersibles and <u>diving systems</u> (3) Other equipment to which the Society deems necessary to pay special attention 	<p>safe working loads and services intended.</p> <p>2 Attention is to be paid to the fact that some states of call require to hold certificates of special form specified by <u>those</u> in addition to the certificates specified in 9.4.1 of the Rules and issued by the Society.</p> <p>1.2 Definitions</p> <p>1.2.1 Terminology</p> <p>The derricks come under the requirements of the Rules include those illustrated in Fig. 1.2.1-1.</p> <p>1.3 Arrangement, Construction, Materials and Welding</p> <p>1.3.2 General Construction</p> <p>1 The <u>cargo gear</u> which are to comply with the additional requirements considered appropriate by the Society in applying the Rules as specified in 1.3.2-1 of the Rules include the following (1) through (4):</p> <ol style="list-style-type: none"> (1) <u>Cargo gear installed on mobile offshore units</u> (2) <u>Cargo gear</u> installed on workboats (3) Hoisting and stowing equipment for submersibles and diving (4) Other equipment to which the Society deems necessary to pay special attention 	

Amended-Original Requirements Comparison Table (Lifting Appliances and Anchor Handling Winches)

Amended	Original	Remarks
<p>2 “Requirements specially made up by the Society” specified in 1.3.2-2, Part 1 of the Rules include the following requirements (1) through (4):</p> <p>(1) Where steel materials of various strengths are used in the structural members, due considerations are to be given to the stress caused in the material of lower strength adjoining that of higher strength.</p> <p>(2) For the members in which high tensile steels are used, special attention is to be paid to the structural details so that significant stress concentration may not take place.</p> <p>(3) Where high tensile steels are extensively used in the structural members, careful considerations are required. In such cases, a thorough study with regard to ensuring buckling strength and the results of the study are to be submitted to the Society.</p> <p>(4) Dimensions of the members are to comply with the following requirements (a) through (e):</p> <p>(a) The minimum thickness of post specified in 3.3.3, Part 1 of the Rules may be obtained from the following formula: $5.0K+1.0$ (mm) where: $K = \sigma_{yM}/\sigma_{yH}$ σ_{yM} : Specified value of yield stress of mild steel σ_{yH} : Specified value of yield stress of high tensile steel</p> <p>(b) The minimum outside diameter of post at the base specified in 3.4.2, Part 1 of the Rules may be as obtained from the following formula: $5hK$ (cm) where:</p>	<p>2 “Requirements specially made up by the Society” specified in 1.3.2-2 of the Rules include the following requirements (1) through (4):</p> <p>(1) Where steel materials of various strengths are used in the structural members, due considerations are to be given to the stress caused in the material of lower strength adjoining that of higher strength.</p> <p>(2) For the members in which high tensile steels are used, special attention is to be paid to the structural details so that significant stress concentration may not take place.</p> <p>(3) Where high tensile steels are extensively used in the structural members, careful considerations are required. In such cases, a thorough study with regard to ensuring buckling strength and the results of the study are to be submitted to the Society.</p> <p>(4) Dimensions of the members are to comply with the following requirements (a) through (e):</p> <p>(a) The minimum thickness of post specified in 3.3.3 of the Rules may be obtained from the following formula: $5.0K+1.0$ (mm) where: $K = \sigma_{yM}/\sigma_{yH}$ σ_{yM} : Specified value of yield stress of mild steel σ_{yH} : Specified value of yield stress of high tensile steel</p> <p>(b) The minimum outside diameter of post at the base specified in 3.4.2 of the Rules may be as obtained from the following formula: $5hK$ (cm) where:</p>	

Amended-Original Requirements Comparison Table (Lifting Appliances and Anchor Handling Winches)

Amended	Original	Remarks
<p><i>h</i> : As specified in 3.4.2, Part 1 of the Rules <i>K</i> : As specified in (a)</p> <p>(c) The value of the coefficient C_2 specified in Table 3.4 in 3.4.3-1(1), Part 1 of the Rules may be substituted by the value of C_2 multiplied by the coefficient K specified in (a).</p> <p>(d) The minimum thickness of the structural members specified in 4.3.7, Part 1 of the Rules may be substituted by the value obtained from the following formula: $5.0K+1.0$ (mm) where: <i>K</i> : As specified in (a)</p> <p>(e) The minimum thickness of the structural members specified in 8.3.4, Part 1 of the Rules may be substituted by the value obtained from the following formulae: Weather part $5.0K + 1.0$ (mm) Enclosed part $5.0K$ (mm) where: <i>K</i> : As specified in (a)</p>	<p><i>h</i> : As specified in 3.4.2 of the Rules <i>K</i> : As specified in (a)</p> <p>(c) The value of the coefficient C_2 specified in Table 3.4 in 3.4.3-1(1) of the Rules may be substituted by the value of C_2 multiplied by the coefficient K specified in (a).</p> <p>(d) The minimum thickness of the structural members specified in 4.3.7 of the Rules may be substituted by the value obtained from the following formula: $5.0K+1.0$ (mm) where: <i>K</i> : As specified in (a)</p> <p>(e) The minimum thickness of the structural members specified in 8.3.4 of the Rules may be substituted by the value obtained from the following formulae: Weather part $5.0K + 1.0$ (mm) Enclosed part $5.0K$ (mm) where: <i>K</i> : As specified in (a)</p>	

Amended-Original Requirements Comparison Table (Lifting Appliances and Anchor Handling Winches)

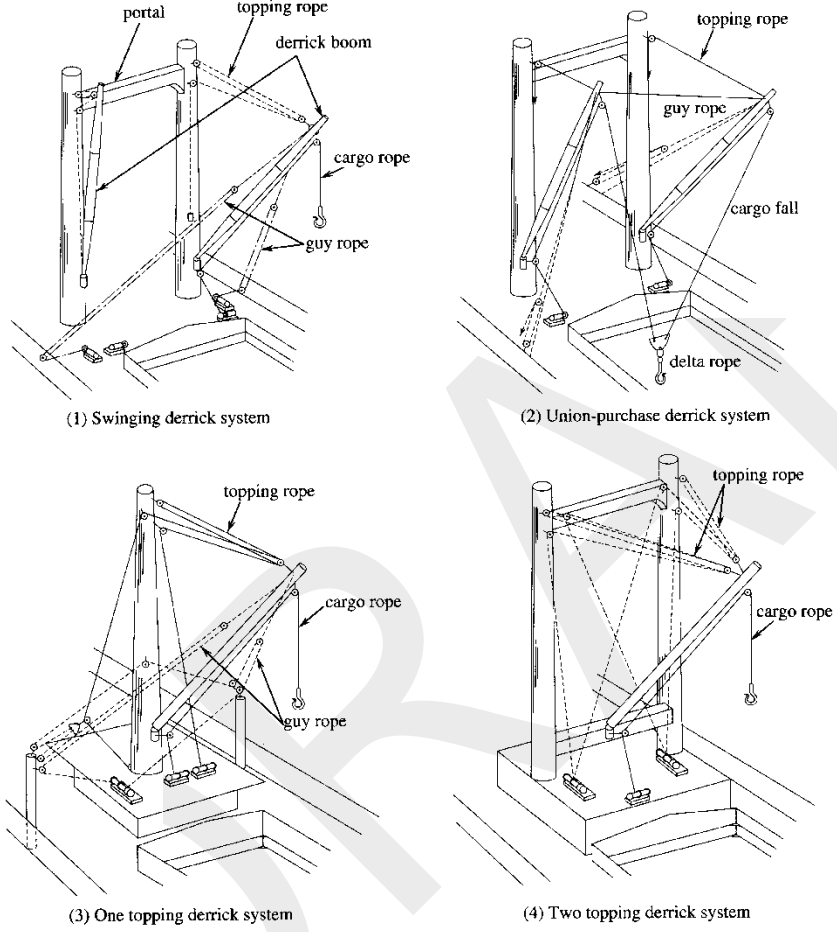
Amended	Original	Remarks
<p style="text-align: center;">Fig. 1.2.1-1 Derrick Systems</p>  <p>(1) Swinging derrick system</p> <p>(2) Union-purchase derrick system</p> <p>(3) One topping derrick system</p> <p>(4) Two topping derrick system</p>		<p>No change</p>

Amended-Original Requirements Comparison Table (Lifting Appliances and Anchor Handling Winches)

Amended	Original	Remarks
<p>1.3.4 Materials</p> <p>1 “Cases considered appropriate by the Society” mentioned in 1.3.4-1, Part 1 of the Rules are the following cases (1) to (3):</p> <p>(1) Where <i>KB</i> of more than <i>25mm</i> in thickness are used in the following members (a) to (c) of the structural members of cranes:</p> <p>(a) Flange for mounting slewing ring (bearing) of jib crane</p> <p>(b) Housing base of jib crane</p> <p>(c) Members constituting movable parts of gantry crane, etc. with increased plate thickness to ensure stiffness. However, requirements specified in Table 1.1, Part 1 of the Rules may be applied according to the magnitude of working stresses</p> <p>(2) Where steel pipes conforming to the following requirements (a) to (d) are used to manufacture the structural members such as derrick booms, derrick posts, crane jibs, crane posts and other similar members:</p> <p>(a) The steel pipes are to be of <i>20mm</i> or less in thickness.</p> <p>(b) The steel pipes are to be of Grade 1 or 2 of steel pipes for pressure piping specified in Part K of the Rules for the Survey and Construction of Steel Ships, or the equivalent thereto.</p> <p>(c) Steel pipes for structural purposes specified in <i>JIS</i> may be used only when the material tests are carried out in the presence of the Society’s Surveyor.</p> <p>(d) Steel pipes to be welded are to be of 0.23% or less</p>	<p>1.3.4 Materials</p> <p>1 “Cases considered appropriate by the Society” mentioned in 1.3.4-1 of the Rules are the following cases (1) to (3):</p> <p>(1) Where <i>KB</i> of more than <i>25mm</i> in thickness are used in the following members (a) to (c) of the structural members of cranes:</p> <p>(a) Flange for mounting slewing ring (bearing) of jib crane</p> <p>(b) Housing base of jib crane</p> <p>(c) Members constituting movable parts of gantry crane, etc. with increased plate thickness to ensure stiffness. However, requirements specified in Table 1.1 of the Rules may be applied according to the magnitude of working stresses</p> <p>(2) Where steel pipes conforming to the following requirements (a) <u>through</u> (d) are used to manufacture the structural members such as derrick booms, derrick posts, crane jibs, crane posts and other similar members:</p> <p>(a) The steel pipes are to be of <i>20mm</i> or less in thickness.</p> <p>(b) The steel pipes are to be of Grade 1 or 2 of steel pipes for pressure piping specified in Part K of the Rules for the Survey and Construction of Steel Ships, or the equivalent thereto.</p> <p>(c) Steel pipes for structural purposes specified in <i>JIS</i> may be used only when the material tests are carried out in the presence of the Society’s Surveyor.</p> <p>(d) Steel pipes to be welded are to be of 0.23% or less</p>	

Amended-Original Requirements Comparison Table (Lifting Appliances and Anchor Handling Winches)

Amended	Original	Remarks
<p>in carbon contents.</p> <p>(3) Where rolled steel material and steel pipes, not exceeding 12.5mm thick, complying with <i>JIS</i> or the standards recognized to be appropriate by the Society are used in the main structural members of <u>lifting appliances</u> which are not employed in cargo handling services excluding those used for cargo hoses. The materials of the members welded directly to the hull structure, however, are to comply with the requirements in 1.3.4-1, <u>Part 1 of the Rules</u> or (2)(a) to (d) above.</p> <p>2 Classification of the steel materials used in the structural members, travelling girders, tracks, etc. of <u>lifting appliances</u> used in areas with low air temperatures or refrigerated hold chambers are to comply with Table 1.3.4-1 according to design temperatures.</p> <p>(Same)</p>	<p>in carbon contents.</p> <p>(3) Where rolled steel material and steel pipes, not exceeding 12.5mm thick, complying with <i>JIS</i> or the standards recognized to be appropriate by the Society are used in the main structural members of <u>cargo gears</u> which are not employed in cargo handling services excluding those used for cargo hoses. The materials of the members welded directly to the hull structure, however, are to comply with the requirements in 1.3.4-1 of the Rules or (2)(a) to (d) above.</p> <p>2 Classification of the steel materials used in the structural members, travelling girders, tracks, etc. of <u>cargo gear</u> used in areas with low air temperatures or refrigerated hold chambers are to comply with Table 1.3.4-1 according to design temperatures.</p> <p>3 Forged or cast steel parts used in the following structural members (1) through (6) may be of the materials conforming to <i>JIS</i> or standards considered equivalent thereto by the Society.</p> <p>(1) Topping bracket of derrick system</p> <p>(2) Gooseneck bracket and gooseneck pin of derrick system</p> <p>(3) Derrick heel lugs and head fitting of derrick boom</p> <p>(4) Heel bracket of jib crane</p> <p>(5) Heel fitting of crane jib</p> <p>(6) Bracket and pin for movable parts of gantry crane, cargo lift and cargo ramps</p>	

Amended-Original Requirements Comparison Table (Lifting Appliances and Anchor Handling Winches)

Amended	Original	Remarks			
Table 1.3.4-1 Classification of Steel Materials Exposed to Low Temperature					
Design temperature T (°C)	Material thickness t (mm)				
	$t \leq 10$	$10 < t \leq 20$	$20 < t \leq 25$	$25 < t \leq 40$	$40 < t$
$-10 \leq T$	<i>A/AH</i>		<i>B/AH</i>	<i>D/DH</i>	<i>E/EH</i>
$-20 \leq T < -10$	<i>B/AH</i>	<i>D/DH</i>	<i>E/EH</i>		
$-30 \leq T < -20$	<i>E/EH</i>			<i>KL24A</i>	<i>KL24B</i>
$-40 \leq T < -30$	<i>KL24A</i>		<i>KL24B</i>		*
$-50 \leq T < -40$	<i>KL24B</i>		*		
Notes:					
<ol style="list-style-type: none"> 1. Steel grades for the construction capable of relieving thermal stress will be specially considered by the Society. 2. The Society may require materials having higher notch toughness according to the material thickness and construction if the design temperature is below -50 °C or working stress of the material exposed to low temperatures exceeds 60 % of the yield point. 3. Steel grades for the members corresponding to classification asterisked * will be specially considered by the Society. 4. Symbols used in this Table are same as those in Table 1.1, Part 1 of the Rules. 					
<p>(Same) (Same)</p>	<p>1.3.5 Welding</p> <p>1 Welding of derrick posts is to comply with the following requirements (1) through (8):</p> <ol style="list-style-type: none"> (1) Welding of post is to be both side welding as far as practicable. (2) Welding of post to deck is to be of double grooved at the foot of post. If inside work of the post is difficult due to small diameter or any other reasons, penetration welding with the backing metal for single groove may be permitted. (3) As for the welding of side plates to upper and lower plates constituting portal, the fillet size, at the portal ends and at the portions where topping brackets, eyes, etc. are fitted are to be of <i>F1</i> weld specified in Table 12.2.1-2, Part 1, Part C of the Rules for the Survey and Construction of Steel Ships. 				

Amended-Original Requirements Comparison Table (Lifting Appliances and Anchor Handling Winches)

Amended	Original	Remarks
	<p>(4) Welding for portal and post are to be both side welding as far as practicable. If angle shown in Fig. 1.3.5-1 is small, the ends of portal are to intersect orthogonally with the post surface by providing knuckle to carry out fillet welding as completely as practicable.</p> <p>(5) Topping brackets and gooseneck brackets are to be fitted by penetrating the post or mounting the base. If the plate thickness of the post or the mounting base exceeds <i>12.5mm</i>, the welding is to be penetration welding with grooves.</p> <p>(6) The joint of derrick boom for circumferential is to be both side welding and back welding after removing defects of face run by back chipping. However, penetration welding with backing metal may be permitted limiting to such an unavoidable case as partial replacement for repair. In this case, the welded joint concerned is to be verified by suitable non-destructive inspection carried out along the whole length of weld line that it is free from injurious defects.</p> <p>(7) The backing metal used for the joint derrick boom for longitudinal joint is to be jointless along the whole length with smooth surface.</p> <p>(8) The requirements in (2), (5) and (6) may be modified for the derricks not used in cargo handling service in consideration of the safe working load and the type of construction.</p>	

Amended-Original Requirements Comparison Table (Lifting Appliances and Anchor Handling Winches)

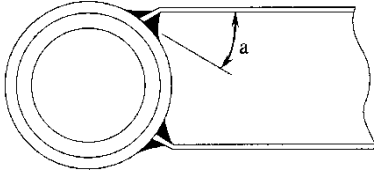
Amended	Original	Remarks
<p>(Same)</p>	<p style="text-align: center;">Fig. 1.3.5-1 Welding for Portal and Post</p>  <p>2 Welding for cranes is to comply with the following requirements (1) to (4):</p> <ol style="list-style-type: none"> (1) In principle, the welded joints of the jib are to be both-side welding (including fillet weld). Where both-side welding is difficult, penetration bead welding or welding with backing strip is to be carried out. (2) As for the welding of crane post, the requirements in -1(1) and (2) are to be applied. (3) The following parts are, as a rule, to be fixed by full penetration welding. <ol style="list-style-type: none"> (a) Fixing part of crane post and post flange for slewing ring (b) Fixing part of bracket for sheave to jib top (c) Fixing part of bracket for sheave to crane house (d) Fixing part of base bracket of jib (e) Fixing part of crane house well and turning table. (4) The fillet weld applied to the primary structural members is, as a rule, to be <i>F1</i> weld specified in Table 12.2.1-1, Part 1, Part C of the Rules for the Survey and Construction of Steel Ships, or equivalent thereto. <p>3 Welding for cargo lifts and cargo ramps is to comply with the following requirements (1) to (3):</p> <ol style="list-style-type: none"> (1) The fillet weld applied to the primary structural members is to comply with the requirements in -2(4). (2) Welding for non-slip bar, etc. fitted directly to the 	
<p>(Same)</p>		

Amended-Original Requirements Comparison Table (Lifting Appliances and Anchor Handling Winches)

Amended	Original	Remarks
<p>4 Welding for the structural members of <u>lifting appliances</u> used in areas with low air temperatures or refrigerated hold chambers is to be carried out in such a way that it may not give any adverse effect on prevention of occurrence of low temperature brittle fracture in consideration of the structure, working stress, etc. (Same)</p> <p>6 Non-destructive inspections for welded joints of structural members of <u>lifting appliances</u> is to comply with the following requirements (1) to (3):</p> <p>(1) The following places (a) to (c) are to be subjected to radiographic test or ultrasonic test:</p> <p>(a) Places specified in -1(6)</p> <p>(b) For structural members of cranes, places specially considered by the Society according to their structure and method of construction as well as the places specified in -2(1)</p> <p>(c) Places being suspicious in integrity of welded joints</p> <p>(2) When the Society deems necessary, the following places corresponding to (a) to (d) are to be subjected</p>	<p>primary structural members is to be carried out in such a way that it may not give any injurious effect on the members.</p> <p>(3) If stoppers, their braces and similar fittings used in stowing the machinery and method of welding are to be selected or carried out in such a way that they do not give any adverse effect on the structural members or hull structures.</p> <p>4 Welding for the structural members of <u>cargo gear</u> used in areas with low air temperatures or refrigerated hold chambers is to be carried out in such a way that it may not give any adverse effect on prevention of occurrence of low temperature brittle fracture in consideration of the structure, working stress, etc.</p> <p>5 When cast steel or forged steel parts are connected to steel plates by butt welding or lap welding, the details of welded joints are to comply with the requirements specified in 12.2, Part 1, Part C of the Rules for the Survey and Construction of Steel Ships.</p> <p>6 Non-destructive inspection for welded joints of structural members of <u>cargo gear and cargo ramps</u> is to comply with the following requirements (1) to (3):</p> <p>(1) The following places (a) to (c) are to be subjected to radiographic test or ultrasonic test:</p> <p>(a) Places specified in -1(6)</p> <p>(b) For structural members of cranes, places specially considered by the Society according to their structure and method of construction as well as the places specified in -2(1)</p> <p>(c) Places being suspicious in integrity of welded joints</p> <p>(2) When the Society deems necessary, the following places corresponding to (a) to (d) are to be subjected</p>	

Amended-Original Requirements Comparison Table (Lifting Appliances and Anchor Handling Winches)

Amended	Original	Remarks
<p>to the magnetic particle test or dye penetrant test:</p> <p>(a) Welded joint of rolled steel plate to cast or forged steel</p> <p>(b) Trace of removing hanging pieces, jigs, etc. welded temporarily to the structural members</p> <p>(c) Weld of cargo fitting</p> <p>(d) Fillet welds of structural members being suspicious in integrity</p> <p>(3) Method of non-destructive test specified in (1) and (2) and judging criteria of defects are to be in accordance with the discretion of the Society according to the construction of the places concerned.</p> <p align="center">Chapter 2 SURVEYS</p> <p>2.1 General</p> <p>2.1.1 Application (Same)</p> <p>(Same)</p>	<p>to the magnetic particle test or dye penetrant test:</p> <p>(a) Welded joint of rolled steel plate to cast or forged steel</p> <p>(b) Trace of removing hanging pieces, jigs, etc. welded temporarily to the structural members</p> <p>(c) Weld of cargo fitting</p> <p>(d) Fillet welds of structural members being suspicious in integrity</p> <p>(3) Method of non-destructive test specified in (1) and (2) and judging criteria of defects are to be in accordance with the discretion of the Society according to the construction of the places concerned.</p> <p align="center">Chapter 2 SURVEYS</p> <p>2.1 General</p> <p>2.1.1 Application</p> <p>1 Posts for derricks and cranes and supports for cargo lifts/ramps fixed directly to the hull structure are to be subjected to the tests and examinations specified in Part B of the Rules for the Survey and Construction of Steel Ships in addition to this chapter.</p> <p>2 Where cargo lifts and cargo ramps constitute part of the hull structure, they are to be subjected to the tests and examinations in compliance with the requirements in Part B of the Rules for the Survey and Construction of Steel Ships, according to the type and arrangement of hull structure.</p>	

Amended-Original Requirements Comparison Table (Lifting Appliances and Anchor Handling Winches)

Amended	Original	Remarks
<p>3 “In cases where considered appropriate by the Society” specified in 2.1.1-4, Part 1 of the Rules means those cases where examinations are carried out in accordance with measures specially approved by the Society. However, this <u>requirement</u> is not to be applied to surveys required by international regulations or the requirements of flag states.</p> <p>2.1.2 Preparation for Surveys and Others (Same)</p> <p>2 With respect to 2.1.2-5, Part 1 of the Rules, surveyors are to confirm at periodical surveys that asbestos-free declarations and supporting documents are provided for any replaced or newly installed fittings, equipment, parts, etc. The wording “materials containing asbestos” means that asbestos is present in the product/material above the threshold value stipulated in Appendix 1 of <i>IMO</i> resolution <i>MEPC.379(80)</i>.</p> <p>2.2 Surveys of <u>Lifting Appliances and Loose Gear</u></p> <p>2.2.2 Timing of Surveys The wording “the Society may approve the survey methods which it considers to be appropriate.” in 2.2.2(4), Part 1 of the Rules means survey methods which the Society considers to be able to obtain information equivalent to that obtained through traditional ordinary surveys where a surveyor is in attendance.</p>	<p>3 “In cases where considered appropriate by the Society” specified in 2.1.1-4 of the Rules means those cases where examinations are carried out in accordance with measures specially approved by the Society. However, this <u>regulation</u> is not to be applied to surveys required by international regulations or the requirements of flag states.</p> <p>2.1.2 Preparation for Surveys and Others</p> <p>1 “The Surveyor considers that the safety for execution of the tests and examinations is not ensured” means that the safety measure of prevention for downfall is not taken at high position survey, etc.</p> <p>2 With respect to 2.1.2-5 of the Rules, surveyors are to confirm at periodical surveys that asbestos-free declarations and supporting documents are provided for any replaced or newly installed fittings, equipment, parts, etc. The wording “materials containing asbestos” means that asbestos is present in the product/material above the threshold value stipulated in Appendix 1 of <i>IMO</i> resolution <i>MEPC.379(80)</i>.</p> <p>2.2 Surveys of <u>Cargo Handling Appliances</u></p> <p>2.2.2 Timing of Surveys The wording “the Society may approve the survey methods which it considers to be appropriate.” in 2.2.2(4) of the Rules means survey methods which the Society considers to be able to obtain information equivalent to that obtained through traditional ordinary surveys where a surveyor is in attendance.</p>	

Amended-Original Requirements Comparison Table (Lifting Appliances and Anchor Handling Winches)

Amended	Original	Remarks
<p>2.2.4 Postponement of <u>Thorough Examinations and Load Tests</u></p> <p>In order to obtain “approval by the Society” specified in 2.2.4, Part 1 of the Rules, the followings are to be complied with.</p> <p>(1) The owner or its representative is to make the application for postponement before the due date in the same manner specified in B1.1.5, Part B of the Guidance for the Survey and Construction of Steel Ships.</p> <p>(2) There is no Society condition relevant to <u>lifting appliances and loose gear</u>.</p> <p>2.3 Registration Surveys</p> <p>2.3.1 Submission of Plans and Documents (Same)</p>	<p>2.2.4 Postponement of <u>Periodical Surveys</u></p> <p>In order to obtain “approval by the Society” specified in 2.2.4 of the Rules, the followings are to be complied with.</p> <p>(1) The owner or its representative is to make the application for postponement before the due date in the same manner specified in B1.1.5 of the Guidance for the Survey and Construction of Steel Ships.</p> <p>(2) There is no Society’s Condition relevant to <u>cargo handling appliances</u>.</p> <p>2.3 Registration Surveys</p> <p>2.3.1 Submission of Plans and Documents</p> <p>1 Submission of drawings of hydraulic motors, hydraulic pumps, steam cylinders, pneumatic motors or internal combustion engines for driving various winches and travelling machines used in cargo handling appliances are to be in accordance with the following requirements (1) to (3) according to the output:</p> <p>(1) Where the output is less than <i>375kW</i>: Submission of drawings may be dispensed with. However, name of manufacturer, type and principal particulars are to be described in the approval drawings of winches or travelling machines employed.</p> <p>(2) Where the output is <i>375kW</i> or more: Principal particulars, drawings of structural details</p>	

Amended-Original Requirements Comparison Table (Lifting Appliances and Anchor Handling Winches)

Amended	Original	Remarks
<p>(Same)</p> <p>2.3.2 Survey 1 Tests and examinations for driving machines, etc. for <u>lifting appliances</u> are to be in accordance with the following requirements (1) to (4):</p>	<p>and strength calculation sheet are to be submitted in one set for reference.</p> <p>(3) Others: Where the machinery is installed in ships under the classification of the Society for the first time, the requirements in (2) are to be applied even when the output is less than 375kW.</p> <p>2 General arrangement plan and structural drawings of derricks are to include at least the following items (1) and (2):</p> <p>(1) General arrangement plan</p> <p>(a) Masts, posts, guy posts, shrouds, stays (including attached rigging screws), derrick booms, and arrangement of cargo fittings fitted to hull structure, etc.</p> <p>(b) Breadth of ship and outreach</p> <p>(c) Positions and name of cargo blocks and arrangement of running ropes (for lifting and slewing)</p> <p>(d) Positions, types and capacities of winches</p> <p>(e) Self-weight of lifting beams, grabs, lifting magnets, spreaders, etc.</p> <p>(2) Structural drawings</p> <p>(a) Construction, dimensions and materials of masts, posts, guy posts and derrick booms</p> <p>(b) Dimensions and materials of shrouds and stays</p> <p>(c) Dimensions and materials of gooseneck brackets, topping brackets, eye plates at upper and lower ends of preventer stays and other cargo fittings</p> <p>2.3.2 Survey 1 Tests and examinations for driving machines, etc. for <u>cargo gear and cargo ramps</u> are to be in accordance with the following requirements (1) to (4):</p>	

Amended-Original Requirements Comparison Table (Lifting Appliances and Anchor Handling Winches)

Amended	Original	Remarks
<p>(1) Hydraulic motors and regulating valves attached thereto:</p> <p>(a) Where the output is less than $375kW$, shop tests may be replaced with the tests conducted by the manufacturer. In this case the Society may require submission of the test results, if it deems necessary.</p> <p>(b) Where the output is $375kW$ or more, hydraulic test may be dealt with in a same way as (a), but performance verification test and open-up examinations are to be carried out in the presence of the Surveyor. The hydraulic (water or oil) test is to be carried out at a pressure of 1.5 times the design pressure.</p> <p>(c) Notwithstanding the requirements (a) and (b) where the driving machines are installed on the class ship of the Society for the first time, the hydraulic test, performance verification test, and open-up examination are all to be carried out in the presence of the Surveyor.</p> <p>(2) Hydraulic pumps: Hydraulic pumps are to be dealt with in similar ways to (1)(a) to (c) depending on the outputs of the driving motors.</p> <p>(3) Steam cylinders, pneumatic motors and internal combustion engines: These are to be dealt with in similar ways to (1)(a) to (c) depending on each output. The hydraulic tests for the steam cylinders are to be carried out at a pressure of 1.5 times the design steam pressure and those for the valves directly connected to the cylinder are to be carried out at a pressure of 2 times the design steam pressure.</p>	<p>(1) Hydraulic motors and regulating valves attached thereto:</p> <p>(a) Where the output is less than $375kW$, shop tests may be replaced with the tests conducted by the manufacturer. In this case the Society may require submission of the test results, if it deems necessary.</p> <p>(b) Where the output is $375kW$ or more, hydraulic test may be dealt with in a same way as (a), but performance verification test and open-up examinations are to be carried out in the presence of the Surveyor. The hydraulic (water or oil) test is to be carried out at a pressure of 1.5 times the design pressure.</p> <p>(c) Notwithstanding the requirements (a) and (b) where the driving machines are installed on the class ship of the Society for the first time, the hydraulic test, performance verification test, and open-up examination are all to be carried out in the presence of the Surveyor.</p> <p>(2) Hydraulic pumps: Hydraulic pumps are to be dealt with in similar ways to (1)(a) to (c) depending on the outputs of the driving motors.</p> <p>(3) Steam cylinders, pneumatic motors and internal combustion engines: These are to be dealt with in similar ways to (1)(a) to (c) depending on each output. The hydraulic tests for the steam cylinders are to be carried out at a pressure of 1.5 times the design steam pressure and those for the valves directly connected to the cylinder are to be carried out at a pressure of 2 times the design steam pressure.</p>	

Amended-Original Requirements Comparison Table (Lifting Appliances and Anchor Handling Winches)

Amended	Original	Remarks
<p>(4) Driving motors for winches or hydraulic pumps and their control equipment: These are to comply with the requirements specified in Part H of the Rules for the Survey and Construction of Steel Ships and to pass the tests and examinations specified in Part H thereof.</p> <p>2 Winches which are used for the <u>lifting appliances</u> (except those specified in -3) are to be subjected to the tests and examinations mentioned in the following (1) and (2) at the shop tests after completion of assembly including installation of driving machines, etc. In this case, one winch selected from those of the same type manufactured at the same time and to be installed on the same ship is to be tested in the presence of the Surveyor, and, if the results are satisfactory, tests and examinations for other winches may be substituted by confirmation of the test results issued by the manufacturer.</p> <p>(1) Electro-hydraulic winches</p> <p>(a) Visual examinations and checking of the construction: It is to be ascertained that no practically injurious defects exist in materials and workmanship and each movable part moves smoothly.</p> <p>(b) No-load test: The winch is to be operated with no load at the maximum speed for 30 <i>minutes</i> (15 <i>minutes</i> for each normal and reverse rotation) and be ascertained that the performance and each structural part is in good order.</p> <p>(c) Load tests: The winch is to hoist and lower the rated load for a period of 30 <i>minutes</i> continuously. (Pause of 20 <i>seconds</i> may be inserted between each hoisting and lowering operation, and effective lift is</p>	<p>(4) Driving motors for winches or hydraulic pumps and their control equipment: These are to comply with the requirements specified in Part H of the Rules for the Survey and Construction of Steel Ships and to pass the tests and examinations specified in Part H thereof.</p> <p>2 Winches which are used for the <u>cargo gear and cargo ramps</u> (except those specified in -3) are to be subjected to the tests and examinations mentioned in the following (1) and (2) at the shop tests after completion of assembly including installation of driving machines, etc. In this case, one winch selected from those of the same type manufactured at the same time and to be installed on the same ship is to be tested in the presence of the Surveyor, and, if the results are satisfactory, tests and examinations for other winches may be substituted by confirmation of the test results issued by the manufacturer.</p> <p>(1) Electro-hydraulic winches</p> <p>(a) Visual examinations and checking of the construction: It is to be ascertained that no practically injurious defects exist in materials and workmanship and each movable part moves smoothly.</p> <p>(b) No-load test: The winch is to be operated with no load at the maximum speed for 30 <i>minutes</i> (15 <i>minutes</i> for each normal and reverse rotation) and be ascertained that the performance and each structural part is in good order.</p> <p>(c) Load tests: The winch is to hoist and lower the rated load for a period of 30 <i>minutes</i> continuously. (Pause of 20 <i>seconds</i> may be inserted between each hoisting and lowering operation, and effective lift is</p>	

Amended-Original Requirements Comparison Table (Lifting Appliances and Anchor Handling Winches)

Amended	Original	Remarks
<p>desirable to be 10<i>m</i> or more.) During this operation, the temperature rise of the bearings, the hoisting speeds, the lowering speeds and the input power are to be measured and ascertained that they are in good order.</p> <p>(d) Braking tests: During hoisting and lowering the rated load for the winch, return the control handle to the neutral position and check the slip of the load (<u>e.g. distance travelled by the load from the point of return to the zero position until the load stops completely.</u>) to be 1.5<i>m</i> or less. Manual releasing test of the brake is also to be carried out and ascertained to be in good order.</p> <p>(e) Speed control tests</p> <p>(f) Emergency assurance tests: The emergency assurance devices provided in the winches is to be ascertained of the performance by cutting off power supply during lowering the rated load.</p> <p>(g) Overload tests: The winch is to hoist and lower a load weighing 125% of the rated load several times. The winch is to be stopped at least three times during lowering the load and ascertained to be in good order.</p> <p>(h) Adjustment of the over-pressure preventive device: The adjusted pressure is to be checked as necessary.</p> <p>(i) Open-up examinations The Society may require an open-up examination of the part where abnormality is found.</p>	<p>desirable to be 10<i>m</i> or more.) During this operation, the temperature rise of the bearings, the hoisting speeds, the lowering speeds and the input power are to be measured and ascertained that they are in good order.</p> <p>(d) Braking tests: During hoisting and lowering the rated load for the winch, return the control handle to the neutral position and check the slip of the to be 1.5<i>m</i> or less. Manual releasing test of the brake is also to be carried out and ascertained to be in good order.</p> <p>(e) Speed control tests</p> <p>(f) Emergency assurance tests: The emergency assurance devices provided in the winches is to be ascertained of the performance by cutting off power supply during lowering the rated load.</p> <p>(g) Overload tests: The winch is to hoist and lower a load weighing 125% of the rated load several times. The winch is to be stopped at least three times during lowering the load and ascertained to be in good order.</p> <p>(h) Adjustment of the over-pressure preventive device: The adjusted pressure is to be checked as necessary.</p> <p>(i) Open-up examinations The Society may require an open-up examination of the part where abnormality is found.</p>	<p align="center">For clarification</p>

Amended-Original Requirements Comparison Table (Lifting Appliances and Anchor Handling Winches)

Amended	Original	Remarks
<p>(j) Other tests deemed necessary by the Surveyor.</p> <p>(2) The shop test for steam winches, electric winches and winches driven by internal combustion engines are also to be carried out in accordance with the requirement specified in (1) for electro-hydraulic winches (except (h)).</p> <p>3 Winches that are used for cranes, special derricks, cargo lifts or cargo ramps and are integrated in their moving bodies are, as a rule, to be handled in accordance with the requirements in -2. However, in case where deemed impracticable by taking into account the construction or arrangement of the winch, part or whole of the tests and examinations specified in -2 may be permitted to be carried out at the time of the Load Tests specified in 2.5, Part 1 of the Rules.</p> <p>4 The wording “the Society may approve other survey methods which it considers to be appropriate” in 2.3.2-3, Part 1 of the Rules means survey methods which it considers to be able to obtain information equivalent to that obtained through traditional ordinary surveys where the Surveyor is in attendance.</p> <p>2.4 Thorough Examinations</p> <p>At <u>thorough examinations</u>, the structural members and loose gear in which corrosion, abrasion or other defects specified in the followings are found are, as a rule, to be repaired or renewed: (Same)</p>	<p>(j) Other tests deemed necessary by the Surveyor.</p> <p>(2) The shop test for steam winches, electric winches and winches driven by internal combustion engines are also to be carried out in accordance with the requirement specified in (1) for electro-hydraulic winches (except (h)).</p> <p>3 Winches that are used for cranes, special derricks, cargo lifts or cargo ramps and are integrated in their moving bodies are, as a rule, to be handled in accordance with the requirements in -2. However, in case where deemed impracticable by taking into account the construction or arrangement of the winch, part or whole of the tests and examinations specified in -2 may be permitted to be carried out at the time of the Load Tests specified in 2.5 of the Rules.</p> <p>4 The wording “the Society may approve other survey methods which it considers to be appropriate” in 2.3.2-3 of the Rules means survey methods which it considers to be able to obtain information equivalent to that obtained through traditional ordinary surveys where the Surveyor is in attendance.</p> <p>2.4 Annual Thorough Surveys</p> <p>At <u>Annual Thorough Surveys</u>, the structural members and loose gear in which corrosion, abrasion or other defects specified in the followings are found are, as a rule, to be repaired or renewed:</p> <p>(1) Structural members (plate members and cargo fittings other than pin construction): Structural members in which amount of wear and tear reaches 10% of the original dimensions. However,</p>	

Amended-Original Requirements Comparison Table (Lifting Appliances and Anchor Handling Winches)

Amended	Original	Remarks
	<p>this may not be applied where steel plates having enough margin to the thickness required by the Rules is used.</p> <p>(2) Cargo fittings of pin construction: Structural members where clearance between pin or similar fitting and its mating hole increases up to 10% of the original diameter of the pin. However, for gooseneck pin the limit of clearance between the cross bolt and the bracket hole is to be 5% of the original diameter of the cross bolt.</p> <p>(3) Loose gear (except wire ropes) For loose gear except wire ropes, those corresponding to any of the followings: (a) Those in which injurious deformation occurred (b) Those in which crack occurred (c) Those in which amount of abrasion or corrosion reaches 10% or more of the original dimensions (d) Blocks whose sheaves do not rotate smoothly</p> <p>(4) Wire ropes Wire ropes corresponding to any of the followings: (a) Those in which 5% or more of total number of independent wires (except filler wires) were broken within a length of 10 times the diameter of wire rope (b) Those in which reduction in diameter of the wire rope reaches 7% or more of the diameter (c) Those in which kink or other injurious deformation occurred (d) Those in which significant corrosion occurred at the surface of independent wires or inside the wire rope (e) In addition to wire ropes specified in the proceedings, those to which the discard criteria</p>	

Amended-Original Requirements Comparison Table (Lifting Appliances and Anchor Handling Winches)

Amended	Original	Remarks
<p>2.5 Load Tests</p> <p>2.5.1 Load Tests (Same)</p> <p>2 For <u>lifting appliances</u> exclusively using grabs, lifting beams, magnets, spreaders and other similar loose gear (hereinafter referred to as “cargo holding gear”), the test load and safe working load may be dealt with in either case of the following (1) or (2) in accordance with the application:</p> <p>(1) Where the mass of loose gear is included in the safe working load: Test load = $\alpha \times \{(\text{maximum cargo mass}) + (\text{mass of cargo holding gear})\}$ Safe working load = (maximum cargo mass) + (mass of cargo holding gear)</p> <p>where: α: a factor obtained from the test load specified</p>	<p>specified in <i>ISO 4309</i> “Wire Rope for Lifting Appliances Code of Practice for Examination and Discard” is applicable are recommended to be discarded.</p> <p>2.5 Load Tests</p> <p>2.5.1 Load Tests</p> <p>1 Load Tests for cranes which are newly constructed, as a rule, are to be carried out after having been assembled at the shops, as well as after having been installed on board the ships. If the results of the shop tests are satisfactory for one crane selected from those of the same type manufactured at the same time and to be installed on the same ship, those for other cranes may be substituted by confirmation of the test results issued by the manufacturer. Where any special reason is admitted by the Surveyor, the Load Tests at the shop may be dispensed with.</p> <p>2 For <u>cargo gear</u> exclusively using grabs, lifting beams, magnets, spreaders and other similar loose gear (hereinafter referred to as “cargo holding gear”), the test load and safe working load may be dealt with in either case of the following (1) or (2) in accordance with the application:</p> <p>(1) Where the mass of loose gears is included in the safe working load: Test load = $\alpha \times \{(\text{maximum cargo mass}) + (\text{mass of cargo holding gear})\}$ Safe working load = (maximum cargo mass) + (mass of cargo holding gear)</p> <p>where: α: a factor obtained from the test load specified</p>	

Amended-Original Requirements Comparison Table (Lifting Appliances and Anchor Handling Winches)

Amended	Original	Remarks
<p>in Table 2.1, Part 1 of the Rules divided by the safe working load. However, for the safe working load not less than $20t$ but less than $50t$, the test load is to be the safe working load plus $5t$.</p> <p>(2) Where the mass of loose gear is not included in the safe working load and the maximum cargo mass only is assigned as the safe working load, the <u>lifting appliance</u> whose safe working load is assigned by this procedure is to satisfy the following conditions:</p> <p>(a) The load tests are to be carried out employing the loose gear used in the <u>lifting appliance</u> concerned or other loose gear having same construction and mass.</p> <p>(b) The loose gear used on board the ship is to be the same gear as used in the load test or those having same construction and mass.</p> <p>Test load = $\alpha \times (\text{maximum cargo mass})$ Safe working load = maximum cargo mass where: α: As specified in (1)</p> <p>3 Load Tests for <u>lifting appliances</u> which are used for solely conventional cargo handling by cargo hook are, as a rule, to be handled in accordance with the manners specified in -2(2).</p> <p>4 Details of Load Tests and operation tests for <u>lifting appliances</u> are to comply with the following requirements in (1) to (4), in addition to those specified in the Rules.</p> <p>(1) Derricks</p> <p>(a) In cases where the assignment of the additional safe working loads specified in 9.2.2(1), Part 1 of the Rules is made, the Load Test for such loads</p>	<p>in Table 2.1 of the Rules divided by the safe working load. However, for the safe working load not less than $20t$ but less than $50t$, the test load is to be the safe working load plus $5t$.</p> <p>(2) Where the mass of loose gears is not included in the safe working load and the maximum cargo mass only is assigned as the safe working load, the <u>cargo gear</u> whose safe working load is assigned by this procedure is to satisfy the following conditions:</p> <p>(a) The load tests are to be carried out employing the loose gears used in the <u>cargo gear</u> concerned or other loose gears having same construction and mass.</p> <p>(b) The loose gears used on board the ship is to be the same gears as used in the load test or those having same construction and mass.</p> <p>Test load = $\alpha \times (\text{maximum cargo mass})$ Safe working load = maximum cargo mass where: α: As specified in (1)</p> <p>3 Load Tests for <u>cargo gear</u> which are used for solely conventional cargo handling by cargo hook are, as a rule, to be handled in accordance with the manners specified in -2(2).</p> <p>4 Details of Load Tests and operation tests for <u>cargo gear and cargo ramps</u> are to comply with the following requirements in (1) to (4), in addition to those specified in the Rules.</p> <p>(1) Derricks</p> <p>(a) In cases where the assignment of the additional safe working loads specified in 9.2.2(1) of the Rules is made, the Load Test for such loads may</p>	

Amended-Original Requirements Comparison Table (Lifting Appliances and Anchor Handling Winches)

Amended	Original	Remarks
<p>may be dispensed with. In such cases, the relationship between the safe working load, etc. and any additional safe working load, etc. is to satisfy the following formula:</p> $B = W \frac{\cos \alpha}{\cos \beta}$ <p>where: <i>W</i>: Safe working load (<i>t</i>) <i>α</i>: Allowable minimum angle (<i>degree</i>) <i>B</i>: Additional safe working load (<i>t</i>) <i>β</i>: Additional allowable angle (<i>degree</i>)</p> <p>(b) Load Tests may be omitted provided that the <u>lifting appliance</u> complies with either of the following conditions:</p> <p>i) For heavy derrick systems: they are not frequently used and the Load Tests will be carried out before use.</p> <p>ii) For union-purchase derrick systems: they passed the Load Tests as a swinging derrick system and the eye plates of the preventer stays are in good order.</p> <p>(2) Jib cranes</p> <p>(a) Where assignment of additional safe working load specified in 9.2.2(2), Part 1 of the Rules is made, the Load Test for the additional safe working load must not be dispensed with.</p> <p>(b) For cranes with constant safe working load regardless of slewing radius, slewing tests are to be carried out at the maximum radius with test load based on the safe working load suspended on it and luffing operation to the minimum radius or the smallest possible radius is to be carried out and slewing test at that radius is also to be carried</p>	<p>be dispensed with. In such cases, the relationship between the safe working load, etc. and any additional safe working load, etc. is to satisfy the following formula:</p> $B = W \frac{\cos \alpha}{\cos \beta}$ <p>where: <i>W</i>: Safe working load (<i>t</i>) <i>α</i>: Allowable minimum angle (<i>degree</i>) <i>B</i>: Additional safe working load (<i>t</i>) <i>β</i>: Additional allowable angle (<i>degree</i>)</p> <p>(b) Load Tests may be omitted provided that the <u>cargo gear</u> complies with either of the following conditions:</p> <p>i) For heavy derrick systems: they are not frequently used and the Load Tests will be carried out before use.</p> <p>ii) For union-purchase derrick systems: they passed the Load Tests as a swinging derrick system and the eye plates of the preventer stays are in good order.</p> <p>(2) Jib cranes</p> <p>(a) Where assignment of additional safe working load specified in 9.2.2(2) of the Rules is made, the Load Test for the additional safe working load must not be dispensed with.</p> <p>(b) For cranes with constant safe working load regardless of slewing radius, slewing tests are to be carried out at the maximum radius with test load based on the safe working load suspended on it and luffing operation to the minimum radius or the smallest possible radius is to be carried out and slewing test at that radius is also to be carried</p>	

Amended-Original Requirements Comparison Table (Lifting Appliances and Anchor Handling Winches)

Amended	Original	Remarks
<p>out as far as practicable.</p> <p>(c) For cranes whose safe working load changes depending on the slewing radius, slewing operations are to be carried out at both the maximum and minimum slewing radius after hoisting the test loads corresponding to each radius.</p> <p>(d) For cranes capable of doing all three of hoisting, slewing and luffing operations or any two out of these three operations simultaneously, these combined operations prescribed in the design specifications are to be verified that they are in satisfactory condition with the test loads corresponding to the limited radius suspended on it.</p> <p>(3) Gantry cranes and other track-mounted cranes</p> <p>(a) The crane is to run on the track within the travelling limits with the test load based on the safe working load suspended on it. In this case, the hull structure supporting the travelling track is also to be confirmed that it is free from defects.</p> <p>(b) Where travelling trolley is employed, it is to run the whole travelling range through with the test load based on the safe working load suspended on it.</p> <p>(c) Where sponson girder of stowing type for travelling trolley is employed, stretching and stowing operations of the girder are to be ascertained that they are in good order.</p> <p>(4) “The method considered appropriate by the Society” in <u>2.5.1-4(5)</u> and <u>2.5.1-5(2)</u>, <u>Part 1</u> of the Rules means the following requirements at least.</p> <p>(a) Accuracy of the load weighing machine is to be</p>	<p>out as far as practicable.</p> <p>(c) For cranes whose safe working load changes depending on the slewing radius, slewing operations are to be carried out at both the maximum and minimum slewing radius after hoisting the test loads corresponding to each radius.</p> <p>(d) For cranes capable of doing all three of hoisting, slewing and luffing operations or any two out of these three operations simultaneously, these combined operations prescribed in the design specifications are to be verified that they are in satisfactory condition with the test loads corresponding to the limited radius suspended on it.</p> <p>(3) Gantry cranes and other track-mounted cranes</p> <p>(a) The crane is to run on the track within the travelling limits with the test load based on the safe working load suspended on it. In this case, the hull structure supporting the travelling track is also to be confirmed that it is free from defects.</p> <p>(b) Where travelling trolley is employed, it is to run the whole travelling range through with the test load based on the safe working load suspended on it.</p> <p>(c) Where sponson girder of stowing type for travelling trolley is employed, stretching and stowing operations of the girder are to be ascertained that they are in good order.</p> <p>(4) “The method considered appropriate by the Society” in <u>2.5.1-4(2)</u> of the Rules means the following requirements at least.</p> <p>(a) Accuracy of the load weighing machine is to be</p>	<p>Applies to lifting appliances located below deck.</p>

Amended-Original Requirements Comparison Table (Lifting Appliances and Anchor Handling Winches)

Amended	Original	Remarks
<p>within the range of $\pm 2.5\%$.</p> <p>(b) Load applying position is to be selected in such a way that the stress generated in the structural members be the most severe within the approved operating range.</p> <p>(c) The load is to be sustained for a period of 5 <i>minutes</i> or more being sufficient to ensure the load indicator remains constant.</p> <p align="center">Chapter 3 DERRICK SYSTEMS</p> <p>3.2 Design Loads</p> <p>3.2.1 Load Considerations (Same)</p> <p>3.2.3 Loads due to Ship Inclination (Same)</p>	<p>within the range of $\pm 2.5\%$.</p> <p>(b) Load applying position is to be selected in such a way that the stress generated in the structural members be the most severe within the approved operating range.</p> <p>(c) The load is to be sustained for a period of 5 <i>minutes</i> or more being sufficient to ensure the load indicator remains constant.</p> <p align="center">Chapter 3 DERRICK SYSTEMS</p> <p>3.2 Design Loads</p> <p>3.2.1 Load Considerations Where strength of derrick systems is to be calculated directly, external forces exerting on top of boom are to include tension in topping lifts, tension in guy ropes, tension in cargo falls (which is caused by the weight of cargo), tension in cargo relief, half of self-weight of boom, and additional loads including self-weight of cargo blocks, hooks, ropes, etc. However, the additional loads may be as given in Table 3.2.1-1.</p> <p>3.2.3 Loads due to Ship Inclination 1 Where an angle of heel less than that specified in the Rules is used for the design of structural members, data concerning ship inclination in service condition in at least the following conditions (1) through (3) are to be submitted to the Society. Longitudinal strength of hull and stability in these conditions are to be separately examined.</p>	

Amended-Original Requirements Comparison Table (Lifting Appliances and Anchor Handling Winches)

Amended	Original	Remarks
<p>2 In ships conducting ballast adjustment to keep angle of heel within that specified in 3.2.3, Part 1 of the Rules in working condition, data concerning the following (1) through (3) are to be submitted to the Society. All <u>data</u> are to be entered in the <u>operation and maintenance manuals for lifting appliances and loose gear</u> referred to in 10.1.2, Part 1 of the Rules.</p> <p>(1) Specifications of equipment for ballast adjustment (2) Method and procedure of ballast adjustment (3) Troubleshooting of equipment for ballast adjustment</p>	<p>(1) Ship light condition (2) On going condition in service of cargo loading (3) Immediately before fully loaded condition</p> <p>2 In ships conducting ballast adjustment to keep angle of heel within that specified in 3.2.3 of the Rules in working condition, data concerning the following (1) through (3) are to be submitted to the Society. All <u>these date</u> are to be entered in the <u>Instruction Manual to Cargo Handling Machinery and Gear</u> referred to in 9.5.2 of the Rules.</p> <p>(1) Specifications of equipment for ballast adjustment (2) Method and procedure of ballast adjustment (3) Trouble-shooting of equipment for ballast adjustment</p>	

Table 3.2.1-1 Additional Loads

Safe working load W (t)	Additional Loads (t)
$W \leq 2$	$0.283W$
$2 < W \leq 15$	$0.4\sqrt{W}$
$15 < W \leq 50$	$0.1W$
$50 < W$	As considered appropriate by the Society

Amended-Original Requirements Comparison Table (Lifting Appliances and Anchor Handling Winches)

Amended	Original	Remarks
<p>Chapter 4 CRANES</p> <p>4.2 Design Loads</p> <p>4.2.2 Impact Loads The “impact load coefficient deemed appropriate by the Society” mentioned in 4.2.2-1, Part 1 of the Rules is the coefficient calculated from the hoisting speed of cranes specified in following (1) or (2). (1) For jib cranes $\varphi = 1 + 0.3V_h$ where $1 + 0.3V_h < 1.1: \quad \varphi = 1.1$ $1 + 0.3V_h > 1.3: \quad \varphi = 1.3$ (2) For other than jib cranes $\varphi = 1 + 0.6V_h$ where $1 + 0.6V_h < 1.1: \quad \varphi = 1.1$ $1 + 0.6V_h > 1.6: \quad \varphi = 1.6$ φ : Impact load coefficient V_h : Hoisting speeds (<i>m/sec</i>)</p> <p>4.2.7 Loads due to Ship Inclination (Same)</p>	<p>Chapter 4 CRANES</p> <p>4.2 Design Loads</p> <p>4.2.2 Impact Loads The “impact load coefficient deemed appropriate by the Society” mentioned in 4.2.2-1 of the Rules is the coefficient calculated from the hoisting speed of cranes specified in following (1) or (2). (1) For jib cranes $\varphi = 1 + 0.3V_h$ where $1 + 0.3V_h < 1.1: \quad \varphi = 1.1$ $1 + 0.3V_h > 1.3: \quad \varphi = 1.3$ (2) For other than jib cranes $\varphi = 1 + 0.6V_h$ where $1 + 0.6V_h < 1.1: \quad \varphi = 1.1$ $1 + 0.6V_h > 1.6: \quad \varphi = 1.6$ φ : Impact load coefficient V_h : Hoisting speeds (<i>m/sec</i>)</p> <p>4.2.7 Loads due to Ship Inclination In calculating loads due to ship inclination to be taken into consideration in the design of cranes, requirements in 3.2.3-1 and -2 specified for derrick systems may be also applied to cranes.</p>	

Amended-Original Requirements Comparison Table (Lifting Appliances and Anchor Handling Winches)

Amended	Original	Remarks																																															
<p>4.2.9 Load Combinations</p> <p>1 Wind loading need not be taken into account for <u>lifting appliances</u> mentioned in the following (1) and (2):</p> <p>(1) <u>Lifting appliances</u> used in cargo holds, engine rooms, and other enclosed spaces in ships</p> <p>(2) <u>Lifting appliances</u> installed on weather decks and used only for loading and unloading articles other than cargo. The Society may, however, require to take the wind loading into account considering the construction system, method of operation, and safe working load of the machinery and gear.</p> <p>2 A “work coefficient deemed appropriate by the Society” mentioned in 4.2.9-2, Part 1 of the Rules is the coefficient obtained based on the ratio of the average lifting load to the safe working load and the cargo load cycles specified in Table 4.2.9-1 in which the coefficient is to be applied upon the agreement between the manufacturer of the lifting appliances and the ordering parties.</p>	<p>4.2.9 Load Combinations</p> <p>1 Wind loading need not be taken into account for <u>cargo gear</u> mentioned in the following (1) and (2):</p> <p>(1) <u>Cargo gear</u> used in cargo hold, engine room, and other enclosed spaces in ship</p> <p>(2) <u>Cargo gear</u> installed on weather deck and used only for loading and unloading articles other than cargo. The Society may, however, require to take the wind loading into account considering the construction system, method of operation, and safe working load of the machinery and gear.</p> <p>2 A “work coefficient deemed appropriate by the Society” mentioned in 4.2.9-2 of the Rules is the coefficient obtained based on the ratio of the average lifting load to the safe working load and the cargo load cycles specified in Table 4.2.9-1 in which the coefficient is to be applied upon the agreement between the manufacturer of the cargo handling appliances and the ordering parties.</p>	<p>No change</p>																																															
<p>Table 4.2.9-1 Work coefficient of cranes</p> <table border="1" style="margin: auto; border-collapse: collapse;"> <thead> <tr> <th rowspan="2" style="text-align: center;">Division (Ratio of the average lifting load to the safe working load $W(t)$)</th> <th colspan="7" style="text-align: center;">Number of loads N (Cargo load cycles)</th> </tr> <tr> <th style="text-align: center;">$N < 6.3 \times 10^4$</th> <th style="text-align: center;">$6.3 \times 10^4 \leq N < 1.2 \times 10^5$</th> <th style="text-align: center;">$1.2 \times 10^5 \leq N < 2.5 \times 10^5$</th> <th style="text-align: center;">$2.5 \times 10^5 \leq N < 5.0 \times 10^5$</th> <th style="text-align: center;">$5.0 \times 10^5 \leq N < 1.0 \times 10^6$</th> <th style="text-align: center;">$1.0 \times 10^6 \leq N < 2.0 \times 10^6$</th> <th style="text-align: center;">$2.0 \times 10^6 \leq N$</th> </tr> </thead> <tbody> <tr> <td style="text-align: center;">Less than 50 % W</td> <td style="text-align: center;">1.00</td> <td style="text-align: center;">1.02</td> <td style="text-align: center;">1.05</td> <td style="text-align: center;">1.08</td> <td style="text-align: center;">1.11</td> <td style="text-align: center;">1.14</td> <td style="text-align: center;">1.17</td> </tr> <tr> <td style="text-align: center;">50 % W or more, but less than 63 % W</td> <td style="text-align: center;">1.02</td> <td style="text-align: center;">1.05</td> <td style="text-align: center;">1.08</td> <td style="text-align: center;">1.11</td> <td style="text-align: center;">1.14</td> <td style="text-align: center;">1.17</td> <td style="text-align: center;">1.20</td> </tr> <tr> <td style="text-align: center;">63 % W or more, but less than 80 % W</td> <td style="text-align: center;">1.05</td> <td style="text-align: center;">1.08</td> <td style="text-align: center;">1.11</td> <td style="text-align: center;">1.14</td> <td style="text-align: center;">1.17</td> <td style="text-align: center;">1.20</td> <td style="text-align: center;">1.20</td> </tr> <tr> <td style="text-align: center;">80 % W or more</td> <td style="text-align: center;">1.08</td> <td style="text-align: center;">1.11</td> <td style="text-align: center;">1.14</td> <td style="text-align: center;">1.17</td> <td style="text-align: center;">1.20</td> <td style="text-align: center;">1.20</td> <td style="text-align: center;">1.20</td> </tr> </tbody> </table> <p>Note: For the calculation of the number of uses, the service life of crane is to be the design life of the crane.</p>			Division (Ratio of the average lifting load to the safe working load $W(t)$)	Number of loads N (Cargo load cycles)							$N < 6.3 \times 10^4$	$6.3 \times 10^4 \leq N < 1.2 \times 10^5$	$1.2 \times 10^5 \leq N < 2.5 \times 10^5$	$2.5 \times 10^5 \leq N < 5.0 \times 10^5$	$5.0 \times 10^5 \leq N < 1.0 \times 10^6$	$1.0 \times 10^6 \leq N < 2.0 \times 10^6$	$2.0 \times 10^6 \leq N$	Less than 50 % W	1.00	1.02	1.05	1.08	1.11	1.14	1.17	50 % W or more, but less than 63 % W	1.02	1.05	1.08	1.11	1.14	1.17	1.20	63 % W or more, but less than 80 % W	1.05	1.08	1.11	1.14	1.17	1.20	1.20	80 % W or more	1.08	1.11	1.14	1.17	1.20	1.20	1.20
Division (Ratio of the average lifting load to the safe working load $W(t)$)	Number of loads N (Cargo load cycles)																																																
	$N < 6.3 \times 10^4$	$6.3 \times 10^4 \leq N < 1.2 \times 10^5$	$1.2 \times 10^5 \leq N < 2.5 \times 10^5$	$2.5 \times 10^5 \leq N < 5.0 \times 10^5$	$5.0 \times 10^5 \leq N < 1.0 \times 10^6$	$1.0 \times 10^6 \leq N < 2.0 \times 10^6$	$2.0 \times 10^6 \leq N$																																										
Less than 50 % W	1.00	1.02	1.05	1.08	1.11	1.14	1.17																																										
50 % W or more, but less than 63 % W	1.02	1.05	1.08	1.11	1.14	1.17	1.20																																										
63 % W or more, but less than 80 % W	1.05	1.08	1.11	1.14	1.17	1.20	1.20																																										
80 % W or more	1.08	1.11	1.14	1.17	1.20	1.20	1.20																																										

Amended-Original Requirements Comparison Table (Lifting Appliances and Anchor Handling Winches)

Amended	Original	Remarks
<p>4.3 Strength and Construction</p> <p>4.3.1 General (Same)</p> <p>(Same)</p> <p>4.3.8 Fixed Posts (Same)</p> <p>(Same)</p>	<p>4.3 Strength and Construction</p> <p>4.3.1 General</p> <p>1 As for slewing ring of the crane, drawings and data given in the following (1) through (5) are to be submitted to the Society. However, for those having operational experiences aboard ships under the classification of the Society, the requirements may be reduced to only those specified in (2).</p> <p>(1) Those giving structural details and materials of slewing ring</p> <p>(2) Allowable values of vertical load, radial load, and upsetting moment exerting on the slewing ring</p> <p>(3) Installation criteria of slewing ring</p> <p>(4) Strength calculation sheet</p> <p>(5) Data on operating experience and quality control during period of manufacture.</p> <p>2 In construction of jib crane house, such portions subjected to concentrated load as fixing parts of brackets for sheaves and wire rope stoppers are to be effectively reinforced.</p> <p>4.3.8 Fixed Posts</p> <p>1 Where the fixing flange of slewing ring of jib crane at the upper part of post is reinforced by brackets, the brackets are at least to be fitted at every two fixing bolts for the slewing ring.</p> <p>2 The method of reinforcement specified in -1 is to be applied also to gantry cranes and other special cranes having slewing ring.</p>	

Amended-Original Requirements Comparison Table (Lifting Appliances and Anchor Handling Winches)

Amended	Original	Remarks
<p>4.4 Special Requirements for Track-mounted Cranes</p> <p>4.4.1 Stability (Same)</p> <p align="center">Chapter 6 LOOSE GEAR</p> <p>6.2 Cargo Blocks</p> <p>6.2.1 Cargo Blocks for Wire Ropes (Same)</p>	<p>4.4 Special Requirements for Track-mounted Cranes</p> <p>4.4.1 Stability Tracks for track-mounted cranes are to comply with the following requirements (1) through (3):</p> <p>(1) The tracks are to have proper cross section, to be properly laid considering expansion and construction due to hull deformation and thermal effect, to be rigid and horizontal, and to have sufficient strength and monolithic travel surface.</p> <p>(2) Where intended to serve as anchor to stop the crane under strong wind condition, the tracks are to be properly designed for the purpose intended.</p> <p>(3) Tracks for electric cranes are to be properly earthed.</p> <p align="center">Chapter 6 LOOSE GEAR</p> <p>6.2 Cargo Blocks</p> <p>6.2.1 Cargo Blocks for Wire Ropes Diameters of equalizer sheaves and sheaves of overload sensing devices at the bottom of groove are to be not less than 10 times and 5 times the diameters of wire ropes to be used, respectively.</p>	

Amended-Original Requirements Comparison Table (Lifting Appliances and Anchor Handling Winches)

Amended	Original	Remarks
<p>6.3 Ropes</p> <p>6.3.1 Wire Ropes</p> <p>Terminal connections of ropes are to comply with the following (1) through (6), as a standard:</p> <p>(1) A loop splice <u>is to</u> have at least three tucks with a whole strand of rope, followed by two tucks with half the wires cut out of each strand.</p> <p>(2) All tucks other than the first <u>are to</u> be against the lay of the rope. If another form of splice is used, it should be as efficient as that described in (1).</p> <p>(3) A splice in which all the tucks are with the lay of the rope <u>is not to</u> be used in the construction of a sling or in any part of a <u>lifting</u> appliance where the rope is apt to twist about its axis.</p> <p>(4) If a loop is made or a thimble secured to a wire rope by means of a compressed metal ferrule, the ferrule should be made to a manufacturer's standard conforming to the following (a) through (e):</p> <p>(a) The material used for the manufacture of the ferrule <u>is to</u> be suitable, particularly to withstand plastic deformation without any sign of cracking.</p> <p>(b) The correct size (both in diameter and length) of ferrule <u>is to</u> be used for the diameter of the rope.</p> <p>(c) The end of the rope that looped back <u>is to</u> pass completely through the ferrule.</p> <p>(d) The correct dies <u>are to</u> be used for the size of the ferrule.</p> <p>(e) The correct closing or compression pressure <u>is to</u> be applied to the dies.</p>	<p>6.3 Ropes</p> <p>6.3.1 Wire Ropes</p> <p>Terminal connections of ropes are to comply with the following (1) through (6), as a standard:</p> <p>(1) A loop splice <u>should</u> have at least three tucks with a whole strand of rope, followed by two tucks with half the wires cut out of each strand.</p> <p>(2) All tucks other than the first <u>should</u> be against the lay of the rope. If another form of splice is used, it should be as efficient as that described in (1).</p> <p>(3) A splice in which all the tucks are with the lay of the rope <u>should not</u> be used in the construction of a sling or in any part of a <u>cargo handling</u> appliance where the rope is apt to twist about its axis.</p> <p>(4) If a loop is made or a thimble secured to a wire rope by means of a compressed metal ferrule, the ferrule should be made to a manufacturer's standard conforming to the following (a) through (e):</p> <p>(a) The material used for the manufacture of the ferrule <u>should</u> be suitable, particularly to withstand plastic deformation without any sign of cracking.</p> <p>(b) The correct size (both in diameter and length) of ferrule <u>should</u> be used for the diameter of the rope.</p> <p>(c) The end of the rope that looped back <u>should</u> pass completely through the ferrule.</p> <p>(d) The correct dies <u>should</u> be used for the size of the ferrule.</p> <p>(e) The correct closing or compression pressure <u>should</u> be applied to the dies.</p>	

Amended-Original Requirements Comparison Table (Lifting Appliances and Anchor Handling Winches)

Amended	Original	Remarks
<p>(5) Where zinc or other alloy is cast in socket to hold the end of rope, work is to be done in accordance with the manufacturer's criteria conforming to the following requirements (a) through (d):</p> <p>(a) Rope length necessary to make alloy casting is to be ensured.</p> <p>(b) Oil and dirt adhering to independent wires are to be completely removed and proper clean surfaces are to be ensured by treatment before casting work.</p> <p>(c) Casting temperature suitable to the characteristics of the alloy is to be properly maintained.</p> <p>(d) Socket is to be preheated before casting of alloy.</p> <p>(6) The terminal fitting of any wire rope <u>is to be</u> capable of withstanding the following loads (a) or (b).</p> <p>(a) Not less than 95% of the minimum breaking load of the rope in the case of a rope of a diameter of 50mm or less</p> <p>(b) Not less than 90% of the minimum breaking load of the rope in the case of a rope of a diameter above 50mm</p>	<p>(5) Where zinc or other alloy is cast in socket to hold the end of rope, work is to be done in accordance with the manufacturer's criteria conforming to the following requirements (a) through (d):</p> <p>(a) Rope length necessary to make alloy casting is to be ensured.</p> <p>(b) Oil and dirt adhering to independent wires are to be completely removed and proper clean surfaces are to be ensured by treatment before casting work.</p> <p>(c) Casting temperature suitable to the characteristics of the alloy is to be properly maintained.</p> <p>(d) Socket is to be preheated before casting of alloy.</p> <p>(6) The terminal fitting of any wire rope <u>should be</u> capable of withstanding the following loads (a) or (b).</p> <p>(a) Not less than 95% of the minimum breaking load of the rope in the case of a rope of a diameter of 50mm or less</p> <p>(b) Not less than 90% of the minimum breaking load of the rope in the case of a rope of a diameter above 50mm</p>	
<p>6.5 Equivalent Requirements</p> <p>6.5.1 General (Same)</p>	<p>6.5 Equivalent Requirements</p> <p>6.5.1 General</p> <p>1 Construction and materials of cargo blocks and hooks are to comply with the following requirements in (1) through (3).</p> <p>(1) Steel blocks are to comply with <i>JIS F 3421, F 3422, F 3428, F 3429</i> or other standards considered</p>	

Amended-Original Requirements Comparison Table (Lifting Appliances and Anchor Handling Winches)

Amended	Original	Remarks
(Same)	<p>appropriate by the Society.</p> <p>(2) Wooden blocks are to comply with standards considered appropriate by the Society.</p> <p>(3) Hooks are to comply with <i>JIS F 2105</i> or other standards considered appropriate by the Society.</p> <p>2 Sheaves, main parts of which are fabricated by welding steel plates, are to be verified prior to application that they have sufficient structural strength by the tests and inspections specified in the following (1) through (6):</p> <p>(1) Welding procedure test (The test items are in accordance with the requirements specified in Chapter 4, Part M of the Rules for the Survey and Construction of Steel Ships. They are, however, increased or decreased according to the type of joint.)</p> <p>(2) Structural strength test (Local and/or total strength)</p> <p>(3) Fatigue test (Test is to be carried out by rotating the sheave at least 10^6 turns under the most severe load condition of the block.)</p> <p>(4) Load Test</p> <p>(5) Verifying test for special process of manufacture such as quenching</p> <p>(6) Verification test for process of manufacture conforming to manufacturing standard (No occurrence of defects such as distortion is to be verified.)</p>	

Amended-Original Requirements Comparison Table (Lifting Appliances and Anchor Handling Winches)

Amended	Original	Remarks
<p align="center">Chapter 7 MACHINERY, ELECTRICAL INSTALLATIONS AND CONTROL ENGINEERING SYSTEMS</p> <p>7.1 General</p> <p>7.1.1 Application “They may be suitably modified” specified in the requirement of winches used for cargo ramps means that the requirements specified in 7.2.2-1(1), 7.2.2-1(2), 7.2.2-1(5), 7.2.2-1(6), 7.4.2-3 and 7.4.3-1, <u>Part 1</u> of the Rules are not to be applied.</p> <p>7.2 Machinery</p> <p>7.2.2 Hoisting and Luffing Winches 1 Winches are to be so designed that the safety factor of the structural parts based on the ultimate tensile strength of the material is not less than the value given as follows according to the safe working load of <u>lifting appliances</u> incorporating the winches concerned: 5 for safe working load is 10<i>t</i> or less 4 for safe working load exceeds 10<i>t</i> 2 Winches which may have to continue stalling condition for a given period with load applied to winch drums are to be provided with devices capable of preventing positively rotation of the drum by means of such mechanism as ratchet in addition to the braking devices specified in 7.2.2-1(4), <u>Part 1</u> of the Rules. In general, winches having</p>	<p align="center">Chapter 7 MACHINERY, ELECTRICAL INSTALLATIONS AND CONTROL ENGINEERING SYSTEMS</p> <p>7.1 General</p> <p>7.1.1 Application “They may be suitably modified” specified in the requirement of winches used for cargo ramps means that the requirements specified in 7.2.2-1(1), 7.2.2-1(2), 7.2.2-1(5), 7.2.2-1(6), 7.4.2-3 and 7.4.3-1 of the Rules are not applied.</p> <p>7.2 Machinery</p> <p>7.2.2 Hoisting and Luffing Winch 1 Winches are to be so designed that the safety factor of the structural parts based on the ultimate tensile strength of the material is not less than the value given as follows according to the safe working load of <u>cargo gear</u> incorporating the winches concerned: 5 for safe working load is 10<i>t</i> or less 4 for safe working load exceeds 10<i>t</i> 2 Winches which may have to continue stalling condition for a given period with load applied to winch drums are to be provided with devices capable of preventing positively rotation of the drum by means of such mechanism as ratchet in addition to the braking devices specified in 7.2.2-1(4) of the Rules. In general, winches having mechanism</p>	

Amended-Original Requirements Comparison Table (Lifting Appliances and Anchor Handling Winches)

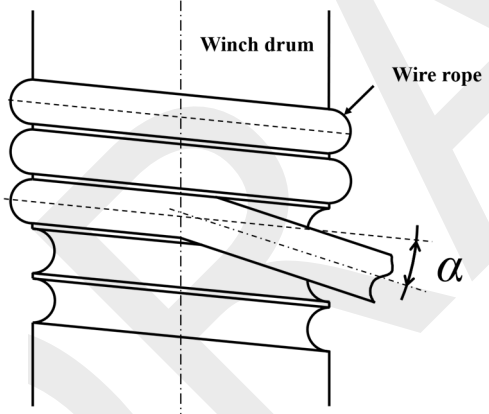
Amended	Original	Remarks
<p>mechanism shown in the following (1) and (2) correspond to these winches:</p> <ol style="list-style-type: none"> (1) Topping drum (or guy drum) of a winch, which drives its cargo hoist drum and topping drum (or guy drum) by a same driving unit through clutch (2) Drum of a topping winch or guy winch, which is used as the end stopper of wire rope holding the boom at its working position <p>3 The “fleet angle” mentioned in 7.2.2-2(1) and 7.2.2-2(2), <u>Part 1 of the Rules</u> is the angle α specified in Fig. 7.2.2-1 and the angle θ specified in Fig. 7.2.2-2 respectively.</p>	<p>shown in the following (1) and (2) correspond to these winches:</p> <ol style="list-style-type: none"> (1) Topping drum (or guy drum) of a winch, which drives its cargo hoist drum and topping drum (or guy drum) by a same driving unit through clutch (2) Drum of a topping winch or guy winch, which is used as the end stopper of wire rope holding the boom at its working position <p>3 The “fleet angle” mentioned in 7.2.2-2(1) and 7.2.2-2(2) of the Rules is the angle α specified in Fig. 7.2.2-1 and the angle θ specified in Fig. 7.2.2-2 respectively.</p>	<p>No change</p>
<p>Fig. 7.2.2-1 Fleet Angle of Grooved Drum</p> 		

Amended-Original Requirements Comparison Table (Lifting Appliances and Anchor Handling Winches)

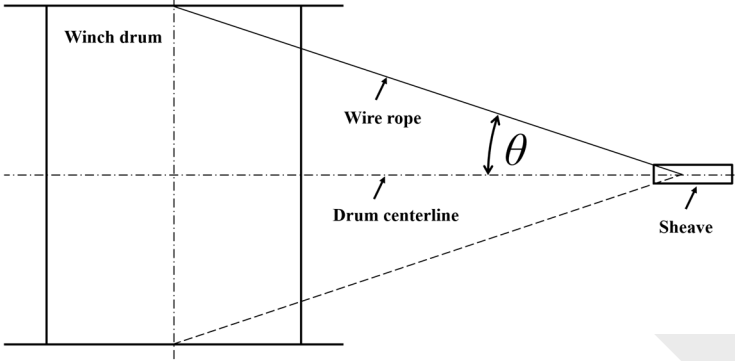
Amended	Original	Remarks
<p data-bbox="562 231 1384 263">Fig. 7.2.2-2 Fleet Angle of Drum other than Grooved Drum</p>  <p data-bbox="168 722 963 863">4 The wording “the rope at its end is to be secured to the drum” specified in 7.2.2-3, Part 1 of the Rules means a force to sustain a load being double the drum load on condition that the wire rope is wound on the drum by four full turns.</p> <p data-bbox="199 938 461 970">7.3 Power Supply</p> <p data-bbox="199 1038 427 1070">7.3.1 General</p> <p data-bbox="168 1078 963 1329">1 Among cables used in power circuit of 600V or less for electric equipment for movable <u>lifting appliances</u>, rubber flexible cords used in portions requiring flexibility and bending strength are to be EP rubber insulated chloroprene cabtire cable of grade 2, 3 or 4 specified in JIS C 3327 or those conforming to other standards considered appropriate by the Society.</p>	<p data-bbox="992 722 1787 863">4 The wording “the rope at its end is to be secured to the drum” specified in 7.2.2-3 of the Rules means a force to sustain a load being double the drum load on condition that the wire rope is wound on the drum by four full turns.</p> <p data-bbox="1023 938 1285 970">7.3 Power Supply</p> <p data-bbox="1023 1038 1252 1070">7.3.1 General</p> <p data-bbox="992 1078 1787 1329">1 Among cables used in power circuit of 600V or less for electric equipment for movable <u>cargo gear</u>, rubber flexible cords used in portions requiring flexibility and bending strength are to be EP rubber insulated chloroprene cabtire cable of grade 2, 3 or 4 specified in JIS C 3327 or those conforming to other standards considered appropriate by the Society.</p>	<p data-bbox="1809 231 1937 263">No change</p>

Amended-Original Requirements Comparison Table (Lifting Appliances and Anchor Handling Winches)

Amended	Original	Remarks
<p>(Same)</p> <p>7.4 Control Engineering Systems</p> <p>7.4.3 Safety System (Same)</p> <p>(Same)</p>	<p>2 High pressure rubber hoses used in the hydraulic oil systems of cranes are to be approved in accordance with the requirements specified in Chapter 12, Part D of the Rules for the Survey and Construction of Steel Ships. However, such hoses are not required to be fire resistant when installed on exposed decks or when installed within cranes located on exposed decks.</p> <p>7.4 Control Engineering Systems</p> <p>7.4.3 Safety System</p> <p>1 Derrick systems are to be provided with devices that indicate the degree of inclination angle of the boom at a position where easily visible to the operator. In addition, it is recommended that derrick systems be provided limit switches to prevent over winding up, slewing and over luffing.</p> <p>2 Cranes are to be provided with safety devices specified in the following (1) through (4):</p> <ol style="list-style-type: none"> (1) Overload preventive device and overload alarm. Cranes not serving cargo handling may dispense with these devices. (2) Limit switches to prevent over winding up, over slewing over luffing except in cases where the cranes are operated by cylinders. (3) Where trolley or crab travels on horizontal jib or luffing jib and safe working load varies depending on the load and radial position of trolley or crab, radial load indicator clearly visible to the operator indicating the following items (a) and (b): <ol style="list-style-type: none"> (a) Safe working load of crane corresponding to the radial position of hook or other hoisting gear 	

Amended-Original Requirements Comparison Table (Lifting Appliances and Anchor Handling Winches)

Amended	Original	Remarks
<p>(Same)</p> <p>4 The emergency stopping device specified in 7.4.2-4, Part 1 of the Rules is to operate independently of other control devices.</p> <p>(Same)</p>	<p>fitted to the hoist rope</p> <p>(b) Limit value for luffing motion of jib or longitudinal motion of trolley/crab. This, however, does not apply to the case where rated load diagram is posted in the operator cab.</p> <p>(4) For cranes having travelling equipment on the body or hoisting device, overrun preventive device on the travelling tracks. In addition, it is recommended that overspeed preventive device be provided.</p> <p>(5) For jib cranes that luff their jib, devices that indicate the degree of inclination angle of the jib are to be provided at a position easily visible to the operator.</p> <p>3 Cargo lifts are to be provided with the safety devices given in the following (1) through (3) as far as practicable:</p> <p>(1) Overload alarm</p> <p>(2) Automatic cutout device for power supply to the driving equipment when hoisting rope or chain slacks</p> <p>(3) Interlock device capable of functioning the following (a) and (b) where locking bars are used in stowing device of the lift</p> <p>(a) Power is not to be supplied to the lift unless all locking bars are pulled out.</p> <p>(b) For hydraulic lifts, locking bars can not be pulled out until oil pressure reaches a pressure sufficient to sustain the lift.</p> <p>4 The emergency stopping device specified in 7.4.2-4 of the Rules is to operate independently of other control devices.</p> <p>5 Cargo ramps are to be provided with the safety devices specified in the following (1) and (2):</p> <p>(1) An alarm device generating alarm before inclination of the ship reaches the value determined in</p>	

Amended-Original Requirements Comparison Table (Lifting Appliances and Anchor Handling Winches)

Amended	Original	Remarks
<p align="center">Chapter 8 CARGO LIFTS AND CARGO RAMPS</p> <p>8.2 Design Loads</p> <p>8.2.4 Loads due to Ship Inclination 1 The load due to ship inclination is, as a rule, to comply with the requirements in 4.2.7, Part 1 of the Rules. The Society, however, may permit to apply value of ship inclination offered, if the data on ship inclination in service conditions are submitted to and deemed appropriate by the Society. (Same)</p> <p>8.3 Strength and Construction</p> <p>8.3.5 Deflection Criteria Concerning deflections of the cargo lifts and cargo ramps, the Society may permit application of values larger than those specified in 8.3.5, Part 1 of the Rules if it considers no obstruction exists in strength and operation of the equipment judging from the operating experience, results of</p>	<p align="center">Chapter 8 CARGO LIFTS AND CARGO RAMPS</p> <p>8.2 Design Loads</p> <p>8.2.4 Loads due to Ship Inclination 1 The load due to ship inclination is, as a rule, to comply with the requirements in 4.2.7 of the Rules. The Society, however, may permit to apply value of ship inclination offered, if the data on ship inclination in service conditions are submitted to and deemed appropriate by the Society.</p> <p>2 Cargo ramps are not, as a rule, to be designed to be capable of operating at a slope of exceeding 1/10.</p> <p>8.3 Strength and Construction</p> <p>8.3.5 Deflection Criteria Concerning deflections of the cargo lifts and cargo ramps, the Society may permit application of values larger than those specified in 8.3.5 of the Rules if it considers no obstruction exists in strength and operation of the equipment judging from the operating experience, results of model tests,</p>	<p>accordance with the requirements in 8.2.4-1 (2) For ramps slewing or travelling with cargo loaded, safety devices determined by the requirements in -1 to -3 depending on the operating system</p>

Amended-Original Requirements Comparison Table (Lifting Appliances and Anchor Handling Winches)

Amended	Original	Remarks
<p>model tests, etc.</p> <p align="center">Annex 1.1.1-2 ADDITIONAL REQUIREMENTS FOR CRANES USED FOR PERSONNEL TRANSFERS</p> <p align="center">Chapter 1 GENERAL</p> <p>1.1 General</p> <p>1.1.1 Application 1 Cranes registered under <u>Part 1 of the Rules for Lifting Appliances and Anchor Handling Winches</u> (hereinafter referred to as “the Rules”) in cases where they are used to transfer personnel are to comply with the requirements in this Annex in addition to the requirements of the Rules. (Same)</p>	<p>etc.</p> <p align="center">Annex 1.1.1-3 ADDITIONAL REQUIREMENTS FOR CRANES USED FOR PERSONNEL TRANSFERS</p> <p align="center">Chapter 1 GENERAL</p> <p>1.1 General</p> <p>1.1.1 Application 1 Cranes registered under the <u>Rules for Cargo Handling Appliances</u> (hereinafter referred to as “the Rules”) in cases where they are used to transfer personnel are to comply with the requirements in this Annex in addition to the requirements of the Rules. 2 The means of embarkation and disembarkation required by the <u>Rules for the Survey and Construction of Steel Ships</u> are not to be substituted by such cranes.</p>	

Amended-Original Requirements Comparison Table (Lifting Appliances and Anchor Handling Winches)

Amended	Original	Remarks
<p>Chapter 2 SURVEYS</p> <p>2.1 Registration Surveys</p> <p>2.1.1 Drawings and Other Documents to be Submitted (Same)</p> <p>(Same)</p> <p>(Same)</p>	<p>Chapter 2 SURVEYS</p> <p>2.1 Registration Surveys</p> <p>2.1.1 Drawings and Other Documents to be Submitted</p> <p>1 Drawings for approval The following drawing is to be submitted to the Society for approval:</p> <p>(1) Equipment added for personnel transfers</p> <p>2 Documents for reference The following document is to be submitted to the Society for reference:</p> <p>(1) Operation manual for personnel transfers</p> <p>3 The operation manual specified in -2(1) is to contain the following (1) to (3):</p> <p>(1) Restrictions on personnel transfer operations, which contain] at least the following:</p> <p>(a) Wind velocity, wave height, and visibility</p> <p>(b) The maximum angle and slewing radius of cranes (horizontal and vertical distance to the object of embarkation or disembarkation)</p> <p>(c) Safe working loads and hoisting, lowering, and swinging speeds</p> <p>(d) Embarkation areas of equipment used to transport personnel such as baskets (hereinafter referred to as “the basket”)</p> <p>(2) Items regarding persons engaged in personnel transfer operations, which contain at least the following:</p> <p>(a) Roles of the operational master</p> <p>(b) Qualification of the crane operator</p>	

Amended-Original Requirements Comparison Table (Lifting Appliances and Anchor Handling Winches)

Amended	Original	Remarks
<p>2.1.2 Examinations at Registration Surveys (Same)</p> <p>(Same)</p>	<p>(c) Arrangement of signalmen in cases where the object of embarkation or disembarkation cannot be visible from the crane control position</p> <p>(d) Means to ensure the safety of persons in the basket and engaged in the operation</p> <p>(e) Communications between the operational master and persons involved</p> <p>(f) Means to address the emergency situations such as rescue means in the case of crane malfunctions</p> <p>(g) Inspection and testing items prior to personnel transfer operations</p> <p>(3) Items to be checked prior to use of the basket, which contain at least the following:</p> <p>(a) Specifications of the basket such as its own weight, SWL and capacity</p> <p>(b) Maintenance records</p> <p>(c) Certifications issued by an official body or a third-party body</p> <p>2.1.2 Examinations at Registration Surveys</p> <p>1 Crane appliances are to be examined and ascertained to be in good order by the following tests and surveys:</p> <p>(1) Operation tests of the equipment added for personnel transfers</p> <p>(2) Other tests considered necessary by the Society</p> <p>2 Appliances specified in Chapter 6 on board the ship and Markings specified in Chapter 7 are to be examined.</p>	

Amended-Original Requirements Comparison Table (Lifting Appliances and Anchor Handling Winches)

Amended	Original	Remarks
<p>2.2 <u>Thorough Examinations</u></p> <p>At <u>thorough examinations</u>, crane appliances are to be examined and ascertained to be in good order by the following tests and surveys, in addition to the requirements in 2.4.2, Part 1 of the Rules.</p> <p>(1) Operation tests specified in 2.1.2-1(1) (2) Examinations specified in 2.1.2-2</p> <p align="center">Chapter 3 CRANES</p> <p>3.1 Safe Working Load</p> <p>The safe working load of the cranes <u>used</u> for personnel transfers is to be less than 50 % of the safe working load specified in Chapter 1, Part 1 of the Rules. The total weight of the basket (sum of its own weight and capacity load) is not to be more than this load.</p> <p align="center">Chapter 4 LOOSE GEAR</p> <p>4.1 General</p> <p>(Same)</p>	<p>2.2 <u>Annual Thorough Surveys</u></p> <p>At <u>annual thorough surveys</u>, crane appliances are to be examined and ascertained to be in good order by the following tests and surveys, in addition to the requirements in 2.4.2 of the Rules.</p> <p>(1) Operation tests specified in 2.1.2-1(1) (2) Examinations specified in 2.1.2-2</p> <p align="center">Chapter 3 CRANES</p> <p>3.1 Safe Working Load</p> <p>The safe working load of the cranes <u>for use</u> for personnel transfers is to be less than 50 % of the safe working load specified in Chapter 1 of the Rules. The total weight of the basket (sum of its own weight and capacity load) is not to be more than this load.</p> <p align="center">Chapter 4 LOOSE GEAR</p> <p>4.1 General</p> <p>The safety factor of any loose gear is to be 10 and more against the safe working load specified in 3.1.</p>	

Amended-Original Requirements Comparison Table (Lifting Appliances and Anchor Handling Winches)

Amended	Original	Remarks
<p>4.2 Wire Ropes</p> <p>In addition to the requirements specified in 6.3.1, Part 1 of the Rules, wire ropes are to be of an anti-rotation type.</p> <p align="center">Chapter 5 MACHINERY, ELECTRICAL INSTALLATIONS AND CONTROL ENGINEERING SYSTEMS</p> <p>5.1 General</p> <p>The machinery, electrical installations and control engineering systems used in the <u>lifting</u> appliances are to be arranged to prevent accidental falls of the basket and are to be able to lower the basket in the case of a power supply malfunction.</p> <p>5.2 Brakes</p> <p>1 The braking system of hoisting machinery is to comply with the following (1) and (2):</p> <p>(1) Brakes normally equipped on hoisting machinery are to be provided with an override device.</p> <p>(2) Hoisting machinery is to be provided with an additional brake which:</p> <p>(a) complies with 7.2.2-1(4), Part 1 of the Rules;</p> <p>(b) is capable of being operated by circuits other than those for the brakes specified in (1); and</p> <p>(c) is provided with an override device.</p>	<p>4.2 Wire Ropes</p> <p>In addition to the requirements specified in 6.3.1 of the Rules, wire ropes are to be of an anti-rotation type.</p> <p align="center">Chapter 5 MACHINERY, ELECTRICAL INSTALLATIONS AND CONTROL ENGINEERING SYSTEMS</p> <p>5.1 General</p> <p>The machinery, electrical installations and control engineering systems used in the <u>cargo handling</u> appliances are to be arranged to prevent accidental falls of the basket and are to be able to lower the basket in the case of a power supply malfunction.</p> <p>5.2 Brakes</p> <p>1 The braking system of hoisting machinery is to comply with the following (1) and (2):</p> <p>(1) Brakes normally equipped on hoisting machinery are to be provided with an override device.</p> <p>(2) Hoisting machinery is to be provided with an additional brake which:</p> <p>(a) complies with 7.2.2-1(4) of the Rules;</p> <p>(b) is capable of being operated by circuits other than those for the brakes specified in (1); and</p> <p>(c) is provided with an override device.</p>	

Amended-Original Requirements Comparison Table (Lifting Appliances and Anchor Handling Winches)

Amended	Original	Remarks
<p>(Same)</p> <p align="center">Chapter 6 OTHER APPLIANCES</p> <p>6.1 Communication Devices</p> <p>(Same)</p> <p>6.2 Wind Gauge</p> <p>(Same)</p> <p>Chapter 7 CERTIFICATION, MARKING AND DOCUMENTATION</p> <p>7.1 Marking of Safe Working Load, etc.</p> <p>7.1.1 Marking for Cranes 1 At the location specified in 9.3.1, Part 1 of the Rules, the safe working load, the maximum slewing radius, and other restrictive conditions of personnel transfers are to be marked.</p>	<p>2 Hydraulic cylinders used for luffing or extending jibs are to be provided with mechanical devices which can maintain the position of the hydraulic cylinders in the case of a loss of power.</p> <p align="center">Chapter 6 OTHER APPLIANCES</p> <p>6.1 Communication Devices</p> <p>Appropriate communication devices are to be provided to the operational master, the crane operator, the signalmen, and persons in the basket.</p> <p>6.2 Wind Gauge</p> <p>Wind gauge is to be provided to ensure that the operational master can be informed of the wind velocity.</p> <p>Chapter 7 CERTIFICATION, MARKING AND DOCUMENTATION</p> <p>7.1 Marking of Safe Working Load, etc.</p> <p>7.1.1 Marking for Cranes 1 At the location specified in 9.3.1 of the Rules, the safe working load, the maximum slewing radius, and other restrictive conditions of personnel transfers are to be marked.</p>	

Amended-Original Requirements Comparison Table (Lifting Appliances and Anchor Handling Winches)

Amended	Original	Remarks
(Same)	<p>2 At the locations of the crane control position and embarkation area, a notice indicating the safe working load, the maximum slewing radius, maximum wind velocity, maximum wave height, minimum visibility, and other restrictive conditions for personnel transfers is to be provided.</p>	

DRAFT

Amended-Original Requirements Comparison Table (Lifting Appliances and Anchor Handling Winches)

Amended	Original	Remarks
<p><u>Part 2 ANCHOR HANDLING WINCHES</u></p> <p><u>Chapter 1 GENERAL</u></p> <p><u>1.3 Arrangement, Construction and Materials</u></p> <p><u>1.3.3 Materials</u></p> <p><u>The wording “any standards recognised by the Society to be of equivalent” in 1.3.3-4, Part 2 of the Rules means national or international standards such as JIS and ISO.</u></p> <p><u>Chapter 2 SURVEYS</u></p> <p><u>2.3 Registration Surveys</u></p> <p><u>2.3.2 Survey</u></p> <p><u>The wording “the Society may approve survey methods which it considers to be appropriate” in 2.3.2-3, Part 2 of the Rules means survey methods which the Society considers to be able to obtain information equivalent to that obtained through traditional ordinary surveys where a surveyor is in attendance.</u></p>	<p>(Newly Added)</p>	

Amended-Original Requirements Comparison Table (Lifting Appliances and Anchor Handling Winches)

Amended	Original	Remarks												
<p>GUIDANCE FOR THE SURVEY AND CONSTRUCTION OF INLAND WATERWAY SHIPS</p> <p>Part 7 MACHINERY INSTALLATIONS</p> <p>Chapter 1 GENERAL</p> <p>1.1.5 Terminology</p> <p>In the Rules, “auxiliaries” are classified as in Table 7.1.1.5-1.</p>	<p>GUIDANCE FOR THE SURVEY AND CONSTRUCTION OF INLAND WATERWAY SHIPS</p> <p>Part 7 MACHINERY INSTALLATIONS</p> <p>Chapter 1 GENERAL</p> <p>1.1.5 Terminology</p> <p>In the Rules, “auxiliaries” are classified as in Table 7.1.1.5-1.</p>													
<p>Table 7.1.1.5-1 Kinds of Auxiliaries</p>														
	<table border="1"> <thead> <tr> <th align="center">Kind of auxiliary</th> <th align="center">Auxiliary machinery items</th> </tr> </thead> <tbody> <tr> <td>Auxiliary machinery for cooling systems</td> <td>Jacket cooling water pumps, Piston cooling water (oil) pumps, Fuel valve cooling water (oil) pumps, Turbocharger cooling water pumps, Circulating water pumps, Cooler cooling water pumps, Generator engine cooling water (oil) pumps, Air compressors cooling water pumps</td> </tr> <tr> <td>Auxiliary machinery for feed water, condensate and draining systems</td> <td>Boiler water circulating pumps, Condensate pumps, Exhaust gas economizer feed pumps, Drain pumps, Feed water pumps</td> </tr> <tr> <td>Auxiliary machinery for fuel oil systems</td> <td>F.O. supply (service) pumps, F.O. transfer pumps, Boiler burning pumps, F.O. purifiers</td> </tr> <tr> <td>Auxiliary machinery for lubricating oil systems</td> <td>Cam shaft L.O. pumps, Turbocharger L.O. pumps, Crosshead L.O. pumps, Reduction gear L.O. pumps, Stern tube L.O. pumps (not applicable for gravitational circulation systems), L.O. purifiers</td> </tr> <tr> <td>Auxiliary machinery for hydraulic systems</td> <td>Hydraulic oil pumps (pumps to supply hydraulic oil to hydraulic circuits for driving or controlling equipment relevant to main propulsion, e.g., controllable pitch propeller oil pumps)</td> </tr> </tbody> </table>	Kind of auxiliary	Auxiliary machinery items	Auxiliary machinery for cooling systems	Jacket cooling water pumps, Piston cooling water (oil) pumps, Fuel valve cooling water (oil) pumps, Turbocharger cooling water pumps, Circulating water pumps, Cooler cooling water pumps, Generator engine cooling water (oil) pumps, Air compressors cooling water pumps	Auxiliary machinery for feed water, condensate and draining systems	Boiler water circulating pumps, Condensate pumps, Exhaust gas economizer feed pumps, Drain pumps, Feed water pumps	Auxiliary machinery for fuel oil systems	F.O. supply (service) pumps, F.O. transfer pumps, Boiler burning pumps, F.O. purifiers	Auxiliary machinery for lubricating oil systems	Cam shaft L.O. pumps, Turbocharger L.O. pumps, Crosshead L.O. pumps, Reduction gear L.O. pumps, Stern tube L.O. pumps (not applicable for gravitational circulation systems), L.O. purifiers	Auxiliary machinery for hydraulic systems	Hydraulic oil pumps (pumps to supply hydraulic oil to hydraulic circuits for driving or controlling equipment relevant to main propulsion, e.g., controllable pitch propeller oil pumps)	
Kind of auxiliary	Auxiliary machinery items													
Auxiliary machinery for cooling systems	Jacket cooling water pumps, Piston cooling water (oil) pumps, Fuel valve cooling water (oil) pumps, Turbocharger cooling water pumps, Circulating water pumps, Cooler cooling water pumps, Generator engine cooling water (oil) pumps, Air compressors cooling water pumps													
Auxiliary machinery for feed water, condensate and draining systems	Boiler water circulating pumps, Condensate pumps, Exhaust gas economizer feed pumps, Drain pumps, Feed water pumps													
Auxiliary machinery for fuel oil systems	F.O. supply (service) pumps, F.O. transfer pumps, Boiler burning pumps, F.O. purifiers													
Auxiliary machinery for lubricating oil systems	Cam shaft L.O. pumps, Turbocharger L.O. pumps, Crosshead L.O. pumps, Reduction gear L.O. pumps, Stern tube L.O. pumps (not applicable for gravitational circulation systems), L.O. purifiers													
Auxiliary machinery for hydraulic systems	Hydraulic oil pumps (pumps to supply hydraulic oil to hydraulic circuits for driving or controlling equipment relevant to main propulsion, e.g., controllable pitch propeller oil pumps)													

Amended-Original Requirements Comparison Table (Lifting Appliances and Anchor Handling Winches)

Amended		Original	Remarks
	Other auxiliary machinery	Boiler draught fans, Air compressors (excluding air compressors for emergency use), Distilling plants (when distillate is used for essential boilers), Others as deemed essential by the Society.	
Auxiliary machinery for manoeuvring and safety	Pumps	Bilge pumps (including pumps for oil-water separators*), Ballast pumps, Fire pumps*	
	Steering-related auxiliary machinery	Steering engines, Side thrusters*, Stabilizers	
	Deck machinery	Windlasses, Mooring winches*, Hydraulic pumps used for windlasses, Hydraulic pumps used for mooring winches*	
	Ventilating fans, blowers, etc.	Ventilating fans (installed in hazardous areas due to flammable gases or gases harmful to the health of personnel in engine room*, boiler room*) Others as deemed essential by the Society.	
Auxiliary machinery for cargo handling	Cargo handling machinery and gear	Hydraulic pumps used for Cargo handling <u>Lifting appliances</u> (items subject to “Rules for the Survey and Construction of Cargo Handling Appliances of Ships”-Part 1 of the Rules for Lifting Appliances and Anchor Handling Winches), Hoisting machinery, Operating equipment	
	Other auxiliary machinery	Others as deemed essential by the Society	
Auxiliary machinery for specific use	Cargo handling equipment for specific Use	Unloaders (Shipborne units), Refrigerating machines for heat insulated containers, etc.	
	Public working equipment	Dredging equipment, Drilling machines, Pile-driving equipment, etc.	
	Fishing equipment	Winches, etc.	
	Marine-products processing equipment	Canning/packing equipment, Conveyors, Ice-making machines, etc.	
	Equipment for specific operations	Equipment specifically designated by the Society	
Remarks: For those items of auxiliary machinery marked by an asterisk, <i>see 1.1.4(4)</i>			

Amended-Original Requirements Comparison Table (Lifting Appliances and Anchor Handling Winches)

Amended	Original	Remarks
<p align="center">GUIDANCE FOR THE APPROVAL AND TYPE APPROVAL OF MATERIALS AND EQUIPMENT FOR MARINE USE</p> <p align="center">Part I GENERAL</p> <p align="center">Chapter 1 GENERAL</p> <p>1.1 Application</p> <p>1 This guidance applies to tests and inspection of materials and equipment for marine use for which advance approval or type approval by the NIPPON KAIJI KYOKAI (hereinafter referred to as “the Society”) are required by the relevant requirements in <u>Rules for the Survey and Construction of Steel Ships, Rules for Lifting Appliances and Anchor Handling Winches, Rules for Cargo Refrigerating Installations, Rules for Diving Systems, Rules for Marine Pollution Prevention Systems, Rules for Ballast Water Management Installations, Rules for Safety Equipment, Rules for the Survey and Construction of Passenger Ships, Rules for High Speed Craft, Rules for the Survey and Construction of Inland Waterway Ships, Rules for the Survey and Construction of Ships of Fibreglass Reinforced Plastics and Rules for Floating Docks, and their Guidance</u> (hereinafter referred to as “Rules etc.”).</p>	<p align="center">GUIDANCE FOR THE APPROVAL AND TYPE APPROVAL OF MATERIALS AND EQUIPMENT FOR MARINE USE</p> <p align="center">Part I GENERAL</p> <p align="center">Chapter 1 GENERAL</p> <p>1.1 Application</p> <p>1 This guidance applies to tests and inspection of materials and equipment for marine use for which advance approval or type approval by the NIPPON KAIJI KYOKAI (hereinafter referred to as “the Society”) are required by the relevant requirements in <u>Rules for the Survey and Construction of Steel Ships, Rules for Cargo Handling Appliances, Rules for Cargo Refrigerating Installations, Rules for Diving Systems, Rules for Marine Pollution Prevention Systems, Rules for Ballast Water Management Installations, Rules for Safety Equipment, Rules for the Survey and Construction of Passenger Ships, Rules for High Speed Craft, Rules for the Survey and Construction of Inland Waterway Ships, Rules for the Survey and Construction of Ships of Fibreglass Reinforced Plastics and Rules for Floating Docks, and their Guidance</u> (hereinafter referred to as “Rules etc.”).</p>	

Amended-Original Requirements Comparison Table (Lifting Appliances and Anchor Handling Winches)

Amended	Original	Remarks
<p align="center">Part 6 MACHINERY</p> <p>Chapter 1 APPROVAL OF STANDARDIZED DESIGN FOR MACHINERY AND EQUIPMENT</p> <p>1.1 General</p> <p>1.1.1 Scope The requirements of this chapter deal with the approval of the drawings and documents which are submitted in advance to the Society as the standardized design designating the construction, dimensions, materials, specifications, etc. on machinery and equipment required to obtain approval by submitting drawings to the Society in accordance with the requirements of 2.1.3, Part B of the Rules for the Survey and Construction of Steel Ships, 2.1.2, Part 2 of the Rules for High Speed Craft, 2.1.2, Part 2 of the Rules for the Survey and Construction of Inland Waterway Ships, 2.3.1-2, Part 1 of the Rules for Lifting Appliances and Anchor Handling Winches and 2.1.1 of the Rules for Cargo Refrigerating Installations.</p>	<p align="center">Part 6 MACHINERY</p> <p>Chapter 1 APPROVAL OF STANDARDIZED DESIGN FOR MACHINERY AND EQUIPMENT</p> <p>1.1 General</p> <p>1.1.1 Scope The requirements of this chapter deal with the approval of the drawings and documents which are submitted in advance to the Society as the standardized design designating the construction, dimensions, materials, specifications, etc. on machinery and equipment required to obtain approval by submitting drawings to the Society in accordance with the requirements of 2.1.3, Part B of the Rules for the Survey and Construction of Steel Ships, 2.1.2, Part 2 of the Rules for High Speed Craft, 2.1.2, Part 2 of the Rules for the Survey and Construction of Inland Waterway Ships, 2.3.1-2 of the Rules for Cargo Handling Appliances and 2.1.1 of the Rules for Cargo Refrigerating Installations.</p>	
EFFECTIVE DATE AND APPLICATION		
<p>1. The effective date of the amendments is 1 January 2026.</p>		